











Bottom Freezer Refrigerator

Use & Care Guide

 Important Safety Instructions	1-2
 Installation	3-6
 Temperature Controls	7
 Fresh Food Features	8-10
 Freezer Features	11
 Food Storage Tips	12
 Care and Cleaning	13-16
 Operating Sounds	17
 Troubleshooting	18-20
Guía de uso y cuidado en español	22-43
Guide d'utilisation et d'entretien français	44-65
Benutzungs- und Pflegeanleitungen – Deutsch	66-87
Italiano – Guida all'uso e alla manutenzione	88-109
Ελληνικές οδηγίες χρήσης και φροντίδας	110-131
Guia de Uso e Cuidado em Português	132-153
Nederlandse gebruiks- en onderhoudshandleiding	154-175
Dansk betjeningsvejledning	176-197
Svensk manual	198-219
Suomenkielinen käyttö- ja huolto-ohje	220-241
Norsk bruks- og vedlikeholdsanvisning	242-263
Türkçe Kullanım ve Bakım Kılavuzu	264-287



Important Safety Instructions

Installer: Please leave this guide with this appliance.

Consumer: Please read and keep this Use & Care Guide for future reference. This guide provides proper use and maintenance information.

Keep sales receipt and/or cancelled check as proof of purchase.

Have complete model and serial number identification of your refrigerator. This is located on a data plate inside the refrigerator compartment, on the upper left side. Record these numbers below for easy access.

Model Number _____

Serial Number _____

Date of Purchase _____

In our continuing effort to improve the quality and performance of our appliances, it may be necessary to make changes to the appliance without revising this guide.

What You Need to Know About Safety Instructions

Warning and Important Safety Instructions appearing in this guide are not meant to cover all possible conditions and situations that may occur. Common sense, caution and care must be exercised when installing, maintaining or operating appliance.

Always contact the manufacturer about problems or conditions you do not understand.

Recognize Safety Symbols, Words, Labels

DANGER

DANGER – Immediate hazards which **WILL** result in severe personal injury or death.

WARNING

WARNING – Hazards or unsafe practices which **COULD** result in severe personal injury or death.

CAUTION

CAUTION – Hazards or unsafe practices which **COULD** result in minor personal injury or property damage.

DANGER

To reduce risk of injury or death, follow basic precautions, including the following:

Important: Junked or abandoned refrigerators are still dangerous – even if they sit out for “just a few days.” If you are getting rid of your old refrigerator, please follow the instructions below to help prevent accidents.

Before you throw away your old refrigerator or freezer:

- Take off the doors.
- Leave the shelves in place so children may not easily climb inside.

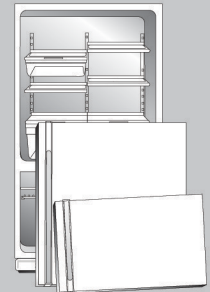

Always disconnect refrigerator from electrical supply before attempting any service.

Plug must be accessible.

This product contains Fluorinated Greenhouse Gases covered by the Kyoto Protocol, the refrigerant gas being in a hermetically sealed system. Refrigerant gas: R134a has a Global Warming Potential (GWP) 1300.



Important Safety Instructions

⚠ WARNING

To reduce risk of fire, electric shock, serious injury or death when using your refrigerator, follow these basic precautions, including the following:

1. Read all instructions *before* using the refrigerator.
2. Observe all local codes and ordinances.
3. Be sure to follow earthing instructions.
4. Check with a qualified electrician if you are not sure this appliance is properly earthed.
5. **Do not** earth to a gas line.
6. **Do not** earth to a cold-water pipe.
7. Refrigerator is designed to operate on a separate 220-240 volt, 10 amp., 50 HZ cycle line.
8. **Do not** modify plug on power cord. If plug does not fit electrical outlet, have proper outlet installed by a qualified electrician.
9. **Do not** use a two-prong adapter, extension cord or power strip.
10. **Do not** tamper with refrigerator controls.
11. **Do not** service or replace any part of refrigerator unless specifically recommended in Use & Care Guide or published user-repair instructions. **Do not** attempt service if instructions are not understood or if they are beyond personal skill level.
12. *Always* disconnect refrigerator from electrical supply before attempting any service. Disconnect power cord by grasping the plug, not the cord.
13. Install refrigerator according to Installation Instructions. All connections for water, electrical power and earthing must comply with local codes and be made by licensed personnel when required.
14. Keep your refrigerator in good condition. Bumping or dropping refrigerator can damage refrigerator or cause refrigerator to malfunction or leak. If damage occurs, have refrigerator checked by qualified service technician.
15. A qualified service technician must replace worn power cords and/or loose plugs.
16. *Always* read and follow manufacturer's storage and ideal environment instructions for items being stored in refrigerator.
17. Your refrigerator **should not** be operated in the presence of explosive fumes.
18. Children **should not** climb, hang or stand on any part of the refrigerator.
19. Clean up spills or water leakage associated with water installation.
20. The appliance is not intended for use by young children or infirm persons without supervision.
21. Young children should be supervised to ensure that they do not play with the appliance.

Installing Your Refrigerator

These instructions were provided to aid you in the installation of your unit. The manufacturer cannot be responsible for improper installation.

Steps to Follow...

A qualified engineer must connect refrigerator in accordance with these installation instructions.

Measure door opening and depth and width of refrigerator. Remove handles or doors if required. Engineer must also do the following:

1. Follow local water and electrical company connection regulations.
2. Complete water supply connection before electrical supply connections.

Service to or replacement of power cord must be performed by a qualified engineer.

Note:

When writing or calling about a service problem, please include the following information:

- a. Your name, address and telephone number;
- b. Model number and serial number;
- c. Name and address of your dealer or engineer;
- d. A clear description of the problem you are having;
- e. Proof of purchase (sales receipt)

SAVE THESE INSTRUCTIONS FOR FUTURE REFERENCE



Installation

⚠ WARNING

To be done by a qualified engineer only.

Your refrigerator was packed carefully for shipment. Remove and discard shelf packaging and tape. **Do not** remove the serial plate.

Measuring the Opening

When installing your refrigerator, measure carefully. 1.3 cm (1/2") of air space should be provided for the top and back of the refrigerator.

60 cm deep models

Note: Trim corners of countertop to a 45° angle if countertop has 25 mm overhang. Provide 5 mm clearance on both sides of refrigerator, and allow 7 mm on top for ease of installation and leveling. No minimum clearance is required at the rear of the cabinet.

Subflooring or floor coverings (i.e. carpet, tile, wood floors, rugs) may make your opening smaller than anticipated.

Some clearance may be gained by using the leveling procedure under *Leveling*.

Important: If refrigerator is to be installed into a recess where the top of the refrigerator is completely covered, use dimensions from floor to top of hinge cap to verify proper clearance.

Transporting Your Refrigerator

- **NEVER** transport refrigerator on its side. If an upright position is not possible, lay refrigerator on its back. Allow refrigerator to sit upright for approximately 30 minutes *before* plugging it in to assure oil returns to the compressor. Plugging the refrigerator in immediately may cause damage to internal parts.
- Use an appliance dolly when moving refrigerator. **ALWAYS** truck refrigerator from its side or back—**NEVER** from its front.
- Protect outside finish of refrigerator during transport by wrapping cabinet in blankets or inserting padding between the refrigerator and dolly.
- Secure refrigerator to dolly firmly with straps or bungee cords. Thread straps through handles when possible. **Do not** over-tighten. Over-tightening restraints may dent or damage outside finish.

Location

- **Do not** install refrigerator near oven, radiator or other heat source. If not possible, shield refrigerator with cabinet material.
- **Do not** install where temperature falls below 13° C or rises above 95° C. Malfunction may occur at this temperature.
- Refrigerator is designed for indoor household application only.

How to Remove and Replace Door and Hinges

⚠ WARNING

Contact a qualified engineer to perform this task.

How to Connect the Water Supply (select models)

⚠ WARNING

Contact a qualified engineer to perform this task.

Leveling

⚠ CAUTION

To protect property and refrigerator from damage, observe the following:

- Protect vinyl or other flooring with cardboard, rugs, or other protective material.
- **Do not** use power tools when performing leveling procedure.

To enhance the appearance and maintain performance, the refrigerator should be level. (side to side)

Notes:

- Complete any required water supply connection *before* leveling.
- Some models only have adjustment screws **(A)**.

Materials Needed:

- 3/8" hex head driver
 - Carpenter's level
1. Remove toe grille.
 - Grasp firmly and pull outward to unclip.

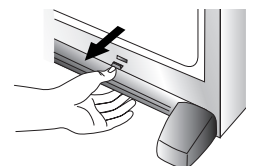



Installation

- Using hex head driver, turn the front adjustment screws **(A)** on each side to raise or lower the front of the refrigerator.



- Select models also have rear adjustment screws **(B)**. Using the hex head driver, turn each of these adjustment screws **(B)** to raise or lower the rear of the refrigerator.
- Using the carpenter's level, make sure front of refrigerator is 6 mm or approximately one half bubble higher than back of refrigerator and that the refrigerator is level from side to side.
- Turn stabilizing legs **(C)** *clockwise* until firmly against floor.
- Freezer drawer models only: Turn adjustment screws (A) counterclockwise to allow the full weight of the refrigerator to rest on the stabilizing legs.**
- Replace the toe grille.
 - Align the toe grille mounting clips with the lower cabinet slots.
 - Snap bottom portion into place first.** Press down on top of grille until top portion snaps into place.

For pullout drawer only:

- Turn both stabilizing legs *clockwise* until firmly against floor. **Turn roller adjustment screws 2 to 3 times counterclockwise so that the full weight of refrigerator rests on stabilizing legs.**

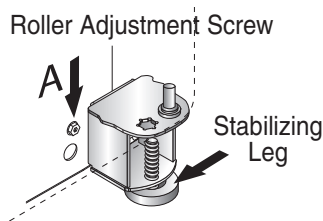

- Replace toe grille. See markings on inside of toe grille to insure proper placement.

Handles

If not installed, the handle is located in the interior of the fresh food section or attached to the back of your refrigerator.

Remove and discard handle packaging and tape.

Handle design varies from refrigerator to refrigerator. Please reference the appropriate instructions for your model below.

Fresh Food Handles

Front Mount Handle - Style 1

Materials Needed:

- Phillips screwdriver
- 5/16" hex head driver

To Install:

- Remove 0.6 cm hex head screws from door face with hex head driver, and Phillips screw from top of door.
 - If reversing door, remove door plugs from opposite side of door and insert in screw holes.
- Align handle holes with screw holes on door face and secure with two door face screws from step 1.
- Locate handle trim in literature pack and install over top and bottom of handle, as illustrated.
 - Secure top handle trim with remaining screw removed in step 1.
 - Snap bottom trim over bottom portion of handle.

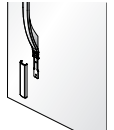
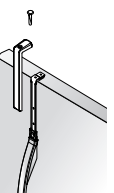
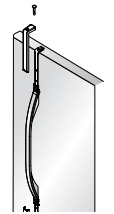
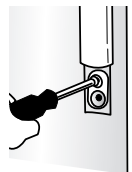
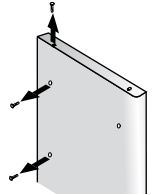

To Remove:

- Remove top handle trim by removing top handle screw.
 - Retain trim and screw for later replacement.
- Pry bottom handle trim from handle with screwdriver flat blade wrapped in masking tape.
 - Retain trim for later replacement.
- Remove two hex head screws.
 - Retain screws for later replacement.

Side Mount Handle

Materials Needed:

- Phillips screwdriver

To Install:

- Remove screws from the side of the door.
- Align the side mount handle with the pre-drilled holes in the door panel.



Installation

3. Insert the screws in the sequence as shown.

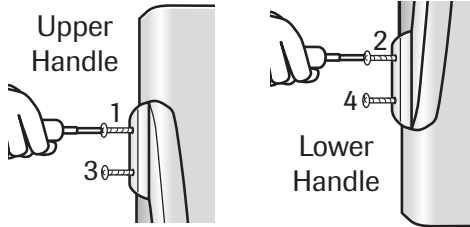

4. Ensure the door handle is snug to the door panel.

To Remove:

Reverse installation procedure.

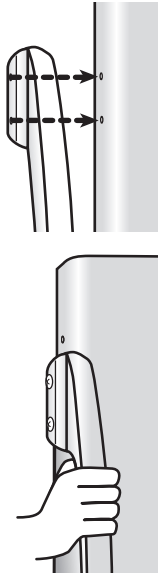

Freezer Handles

Partial-Width Handle

Materials Needed:

- Phillips screwdriver

To Install:

1. Install handle by fastening with screws removed from edge of door.
 - If reversing freezer door, remove door plugs from top edge of door and insert into screw holes.

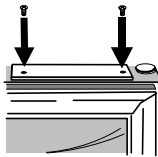

To Remove:

1. Remove handle screws with Phillips screwdriver and retain screws for later use.

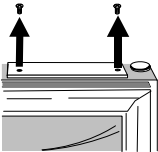

Front Mount Handle - Style 2

Materials Needed:

- Gloves to protect hands

Attach Extensions to Handle: (select models)

1. Align handle and extension as shown.
2. Place extension in handle opening.
3. Apply slight pressure to both sides of the extension piece.
4. Slide extension until it stops on inside edge of handle.

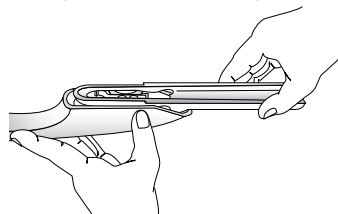

To Install:

1. The handles are to be oriented as shown.
2. Align door handle clip with the door studs.
3. Ensure the large hole in the mounting clip is positioned down on both ends of the handle.
4. Rotate the handle so that the handle is flat against the door.

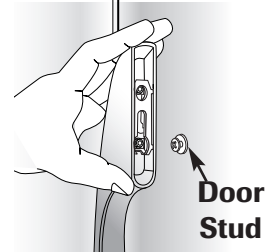
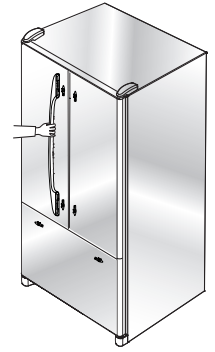

5. Grasp the handle firmly and slide down.

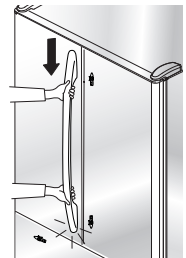
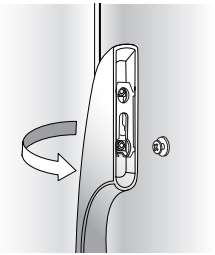

To Remove:

1. Grasp the lower part of the handle firmly, slide up, lift and remove from the surface.

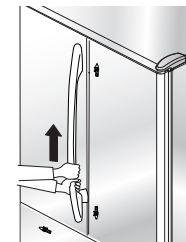

Front Mount Freezer Handle

Materials Needed:

- Gloves to protect hands.

Notes:

- There is a slight curve to this style of freezer handle.
- For proper installation, be sure handle is oriented as shown.

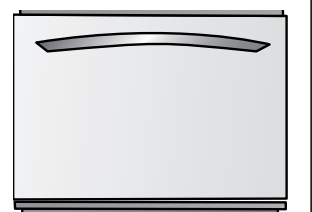



Installation

To Install:

1. Align drawer handle clips to the left of the studs attached to the freezer drawer.
2. Ensure the large hole in the mounting clip is positioned to the right on both ends of the handle.
3. Rotate the handle so the left base is flat against the door.
4. Grasp the handle firmly and slide handle to the right.

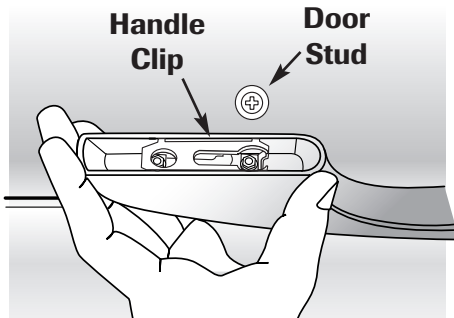

To Remove:

1. With both hands, firmly grasp the handle toward the right side.
2. Slide toward the *left*, lift and remove from the surface.

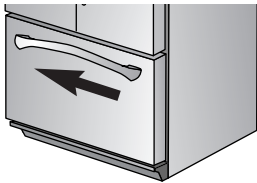

Handle Removal

Euro Handles

This handle style is installed at the factory

Materials Needed:

- $\frac{3}{32}$ " Allen wrench

To Remove:

- Remove set screw from handle mounting post using $\frac{3}{32}$ " Allen wrench.
- Repeat the procedure on all posts to remove the handle.

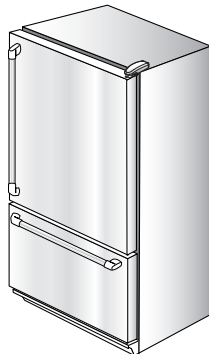

To Replace:

- Align handle with the mounting posts.
- Fully tighten all set screws to secure handle in place.

Opening and Closing Your Fresh Food Doors (select models)

Your new refrigerator is uniquely designed with two fresh food doors. Either door can be opened or closed independently of one another.

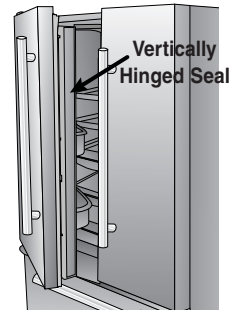

There is a vertically-hinged section on the left fresh food door. When the left door is closed, the hinged section automatically forms a seal between the two doors when both doors are closed.

When the left door is opened, the hinged seal automatically folds inward so that it is out of the way.

⚠ WARNING

To avoid electrical shock which can cause severe personal injury or death, **DO NOT** attempt to remove the hinged seal from the fresh food section.

⚠ CAUTION

To avoid possible product damage, **ALWAYS** verify that the hinged seal is folded against the edge of the door prior to closing.

How to Connect the Water Supply (select models)

⚠ WARNING

Contact a qualified engineer to perform this task.

Ice Maker Operation

- To turn ice maker **On** push arm down from locked position.

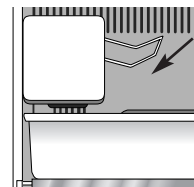

- Lift arm up and lock into position to turn ice maker **Off**.



Temperature Controls

Touch Temperature Controls (select models, style varies by model)



The controls are located at the top front of the refrigerator compartment.

Control



Initial Control Settings

After plugging the refrigerator in, set the controls.

- Pressing the  or  pads adjusts the controls to the desired setting.
- The temperature control range for both compartments is 1 through 7 (coldest).
- Set the Freezer control on **4**.
- Set the Refrigerator control on **4**.
- Let the refrigerator run at least 8 to 12 hours *before* adding food.





Warm Cabinet Surfaces

At times, the front of the refrigerator cabinet may be warm to the touch. This is a normal occurrence that helps prevent moisture from condensing on the cabinet. This condition will be more noticeable when you first start the refrigerator, during hot weather and after excessive or lengthy door openings.

Adjusting the Controls

- 24 hours after adding food, you may decide that one or both compartments should be colder or warmer. If so, adjust the control(s) as indicated in the *Temperature Control Guide* table below. See page 12 for instructions on checking compartment temperature.
- Except when starting the refrigerator, **do not** change either control more than one number at a time.
- Allow 24 hours for temperatures to stabilize.

Temperature Control Guide

Refrigerator too warm	Set the Refrigerator control to next higher number by pressing the  pad.
Refrigerator too cold	Set the Refrigerator control to next lower number by pressing the  pad.
Freezer too warm	Set the Freezer control to next higher number by pressing the  pad.
Freezer too cold	Set the Freezer control to next lower number by pressing the  pad.
Turn control OFF	Press the Refrigerator or freezer  pad until a dash (–) appears in the display.



Fresh Food Features

Shelves

⚠ CAUTION

To avoid personal injury or property damage, observe the following:

- **Never** attempt to adjust a shelf that is loaded with food (except in the case of the Elevator™ shelf).
- Confirm shelf is secure *before* placing items on shelf.
- Handle tempered glass shelves carefully. Shelves may break suddenly if nicked, scratched, or exposed to sudden temperature change.

Your refrigerator has either Spill-Catcher™ or non-sealed Shelves. The Spill-Catcher™ shelves have a spill retainer edge which allows for easier clean up and some are equipped with the Easy Glide™ slide out feature. To slide out (select models), grasp the front of the shelf and pull forward. Push in the shelf to return to the original position.

To Remove a Shelf:

- Slightly tilt up the front and lift up the rear of the shelf, then pull the shelf straight out.

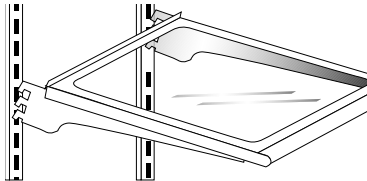

To Lock the Shelf Into Another Position:

- Tilt up the front edge of the shelf.
- Insert the hooks into the desired frame openings and let the shelf settle into place.
- Be sure the shelf is securely locked at the rear.

Elevator™ Shelf (select models)

The fresh food compartment is equipped with an Elevator™ shelf.

This shelf can be adjusted up or down without having to be unloaded of its contents. To adjust an Elevator™ shelf, pull out the knob on the crank handle. Rotate the crank *clockwise* to raise the height of the shelf, and *counterclockwise* to lower the height of the shelf.

Note: Do not raise the shelf to the very top of the vertical rails, as the shelf may become jammed.

To Remove:

Completely unload the shelf and pull the shelf forward. When the shelf stops, press up on the tabs located underneath its outside edges, then continue pulling forward, clear of the frame.

To Install:

Align the shelf to the frame and push it all the way back. (There is no need to depress the tabs for reinstallation).

In ordinary use, the Elevator™ shelf frame assembly does not require removal. Though unlikely, and not recommended, the correct removal procedure is as follows:

To Remove:

- Unload the shelf completely.
- Remove glass shelf by pulling forward. When shelf stops lift up and continue pulling forward.
- Manually move the two rear latches toward the shelf center.
- While supporting the entire shelf and frame from underneath, lift slightly and rotate the assembly approximately 30° to allow the rear mechanism to clear the vertical rear side rails.
- The entire assembly can then be moved forward and clear of the refrigerator compartment.

To Install:

- Reverse the removal procedure. Be sure the shelf is in a level position.
- When the sliding shelf is pushed to the rear, it will reposition the rear latches to their correct operating position.

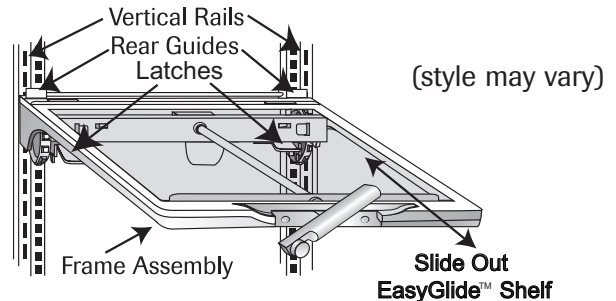



Fresh Food Features

Door Storage

Dairy Compartment

The Dairy Compartment provides convenient door storage for spreadable items such as butter and margarine. This compartment can be moved to different locations to accommodate storage needs. To use the dairy compartment, raise the cover.

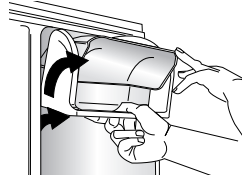

To Remove:

- Raise the cover, pull upward and tilt out.

To Install:

- Reverse above procedure.

Door Buckets

Door Buckets can be moved to meet storage needs.

To Remove:

- Slide bucket up and pull straight out.

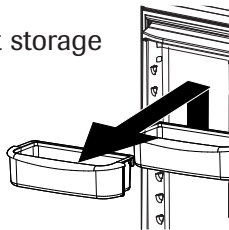

To Install:

- Slide bucket in and down until firmly seated in the door liner.

Full-Width Door Shelf

Full-Width Door Shelf removes for easy cleaning.

To Remove:

- Slide shelf up and pull straight out.

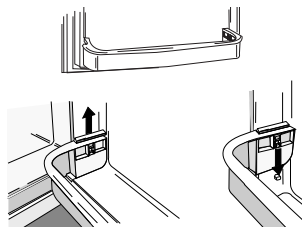

To Install:

- Reverse above procedure.

Storage Drawers

Crisper Top

The Crisper Top serves as the lower fresh food shelf.

To Remove the Crisper Top:

- Remove crisper drawers as indicated on page 11.
- Place hand under the frame to push up the glass. Lift glass out.
- Lift frame from refrigerator liner rails.

To Install:

- Repeat above instructions in reverse order.

Snack Drawer (select models)

The Snack Drawer can be used for storage of miscellaneous items or extra produce.

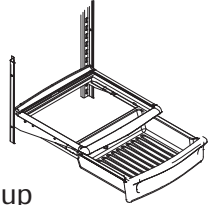

To Remove:

- Pull drawer out to full extension. Tilt up front of drawer and pull straight out.

To Install:

- Insert drawer into frame rails and push back into place.

Beverage Chiller™ (select models)

The Beverage Chiller™ keeps beverages and other items cooler than the rest of the fresh food section. A cold air inlet allows air from the freezer section to pass into the beverage chiller. The Beverage Chiller™ control is located on the left wall of the fresh food compartment. The control adjusts the amount of cold air allowed in to the beverage chiller. For a cooler temperature in the Beverage Chiller™ slide the control down.

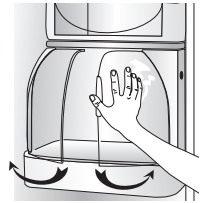

To Remove:

- First remove the pick off shelf to the left of the Beverage Chiller™.
- Firmly hold each side of beverage chiller, lift up and away from door liner.

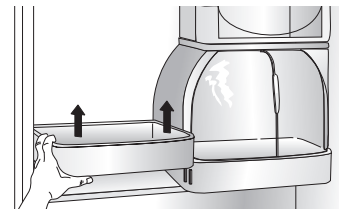

To Install:

- Reverse above procedure.

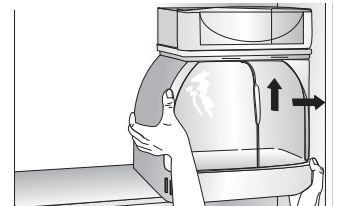



Fresh Food Features

Humidity-Controlled Crisper Drawers

The Crisper Drawers provide a higher humidity environment for fresh fruit and vegetable storage.

Controls

The Crisper Controls regulate the amount of humidity in the crisper drawer. Slide the control toward the **Fruit** setting when storing produce with outer skins. Slide the control toward the **Vegetable** setting when storing leafy produce.



To Remove:

- Pull drawer out to full extension. Tilt up front of drawer and pull straight out.

To Install:



- Insert drawer into frame rails and push back into place.

Note: For best results, keep the crisper drawers tightly closed.

Temperature-Controlled Drawer (select models)

The deli drawer is a full-width drawer with adjustable temperature control. This drawer can be used for large party trays, deli items, beverages or miscellaneous items.

There is a temperature control which adjusts the amount of cold air allowed into the drawer. The control is located on the right side of the drawer. Depending on your model, it is either on the front of the drawer or under the lid.

Set the control to **cheese** or  to provide a normal refrigerator temperature. Set the drawer on the **meats** or  setting when a temperature colder than the main refrigerator compartment is desired. Use the coldest setting when storing meats.

Notes:

- Cold air directed to the drawer can decrease refrigerator temperature. Refrigerator control may need to be adjusted.
- **Do not** place leafy vegetables in the drawer. Colder temperatures could damage leafy produce.

To Remove:

- Lift lid (select models). Pull drawer out to full extension. Tilt up front of drawer and pull straight out.

To Install:

- Push metal glide rails to the back of the refrigerator (select models). Place drawer onto rails and slide drawer back until it falls into place.

Some models feature a divider to organize the drawer into sections.

To Remove:

- Pull drawer completely out and raise the front of the divider to unhook it from the rear wall of the drawer and lift it out.

To Install:

- Hook back of divider over rear wall of the drawer and lower into place.

Accessories (select models)

Wine Trivet/Can Rack

The Wine Trivet/Can Rack accessory fits in the deli drawer or on a shelf.

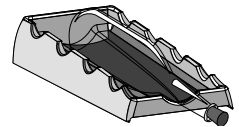

Bottles or cans can be laid crosswise, or a single bottle may be laid in the center depression.

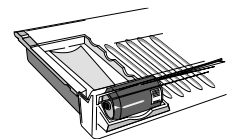

Egg Cradle

The Egg Cradle (style may vary/select models) holds a “dozen-plus” eggs. It can be removed to carry to work area or to be washed.

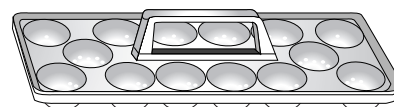



Freezer Features

Shelves and Baskets

Models with swing freezer door:

Freezer Shelf (select models)

Select models have a shelf divider.

To Remove:

- Pull shelf out to full extension. Tilt up front of shelf and pull straight out.

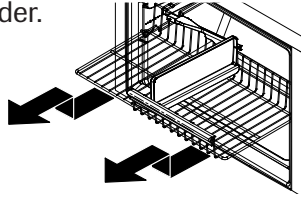

To Install:

- Insert shelf into freezer liner rails and push to back of compartment.

Wire Basket (select models)

To Remove:

- Pull basket out to full extension. Tilt up front of basket and pull straight out.

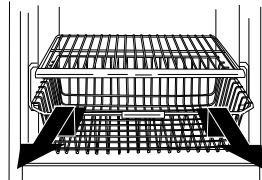

To Install:

- Insert basket into freezer liner rails and push back into place.

Freezer Door Shelf (select models)

The Freezer Door Shelf provides convenient storage for frozen food items in freezer door.

To Remove:

- Lift shelf from side liner tabs and pull out.

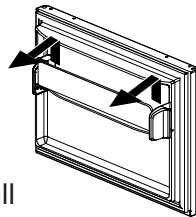

To Install:

- Fit ends of shelf on liner tabs and slide down.

Models with pullout freezer drawer:

⚠ DANGER

To prevent accidental child entrapment or suffocation risk, **do not** remove the divider in the top freezer basket.

Upper Wire Basket

To Remove:

- Pull upper basket out to full extension and lift out to remove.

To Install:

- Slide upper basket into freezer. Make sure that rear of basket hooks behind rail catch.

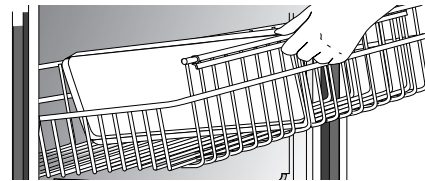

Accessories (select models)

Ice Cube Tray

The Ice Cube Tray provides an area to freeze cubes for manual dispensing of ice.

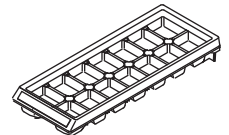

To release ice cubes from tray, hold tray upside down over a storage container and twist both ends of tray until cubes release.

The Ice Service Rack (select models) holds the ice cube tray.

To Install:

- Slide L-shaped groove of shelf down over back wall screw. Push rack back until screw is stopped in L-shaped groove **(1)**. Slide front portion of shelf over front wall screw **(2)**.

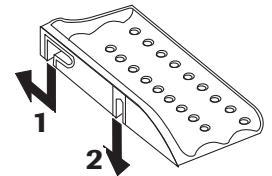

To Remove:

- Perform above steps in reverse order.



Food Storage Tips

Fresh Food Storage

- The fresh food compartment of a refrigerator should be kept between 1°-4° C with an optimum temperature of 3° C. To check the temperature, place an appliance thermometer in a glass of water and place in the center of the refrigerator. Check after 24 hours. If the temperature is above 4° C adjust the controls as explained on page 7.
- Avoid overcrowding the refrigerator shelves. This reduces the circulation of air around the food and results in uneven cooling.

Fruits and Vegetables

- Storage in the crisper drawers traps humidity to help preserve the fruit and vegetable quality for longer time periods (see page 10).
- Sort fruits and vegetables *before* storage and use bruised or soft items first. Discard those showing signs of decay.
- *Always* wrap odorous foods such as onions and cabbage so the odor does not transfer to other foods.
- While vegetables need a certain amount of humidity to remain fresh, too much humidity can shorten storage times (especially leafy vegetables). Drain vegetables well *before* storing.
- Wait to wash fresh produce until right *before* use.

Meat and Cheese

- Raw meat and poultry should be wrapped securely so leakage and contamination of other foods or surfaces does not occur.
- Occasionally mold will develop on the surface of hard cheeses (Swiss, Cheddar, Parmesan). Cut off at least an inch around and below the moldy area. Keep your knife or instrument out of the mold itself. **Do not** try to save individual cheese slices, soft cheese, cottage cheese, cream, sour cream or yogurt when mold appears.

Dairy Food

- Most dairy foods such as milk, yogurt, sour cream and cottage cheese have freshness dates on their cartons for appropriate length of storage. Store these foods in the original carton and refrigerate immediately after purchasing and after each use.

Frozen Food Storage

- The freezer compartment of a refrigerator should be kept at approximately -18° C. To check the temperature, place an appliance thermometer between the frozen packages and check after 24 hours. If the temperature is above -18° C, adjust the control as described on page 7.
- A freezer operates more efficiently when it is at least two-thirds full.

Packaging Foods for Freezing

- To minimize dehydration and quality deterioration use aluminum foil, freezer wrap, freezer bags or airtight containers. Force as much air out of the packages as possible and be sure they are tightly sealed. Trapped air can cause the food to dry out, change color and develop an off-flavor (freezer burn).
- Overwrap fresh meats and poultry with suitable freezer wrap prior to freezing.
- **Do not** refreeze meat that has completely thawed.

Loading the Freezer

- Avoid adding too much warm food to the freezer at one time. This overloads the freezer, slows the rate of freezing and can raise the temperature of frozen foods.
- Leave space between the packages so cold air can circulate freely, allowing food to freeze as quickly as possible.
- Avoid storing hard-to-freeze foods such as ice cream and orange juice on the freezer door shelves. These foods are best stored in the freezer interior where the temperature varies less with door openings.



Care and Cleaning

⚠ CAUTION

To avoid personal injury or property damage, observe the following:

- Read and follow manufacturer's directions for all cleaning products.
- **Do not** place buckets, shelves or accessories in dishwasher. Cracking or warping of accessories may result.

⚠ WARNING

To avoid electrical shock which can cause severe personal injury or death, disconnect power to refrigerator *before* cleaning. After cleaning, reconnect power.

Refrigerator Cleaning Chart

PART	DO NOT USE	DO
Smooth or Textured Painted Doors and Exterior (select models) <i>Damage to finish due to improper use of cleaning products or non-recommended products is not covered under this product's warranty.</i>	Abrasive or harsh cleaners Ammonia Chlorine bleach Concentrated detergents or solvents Metal or plastic-textured scouring pads	Use 4 tablespoons of baking soda dissolved in 1 quart (1 liter) warm, soapy water. Rinse surfaces with clean, warm water and dry immediately to avoid water spots.
Cabinet Interior		
Stainless Steel Doors and Exterior (select models) Important: <i>Damage to stainless steel finish due to improper use of cleaning products or non-recommended products is not covered under this product's warranty.</i>	Abrasive or harsh cleaners Ammonia Chlorine bleach Concentrated detergents or solvents Metal or plastic-textured scouring pads Vinegar-based products Citrus-based cleaners	Use warm, soapy water and a soft, clean cloth or sponge. Rinse surfaces with clean, warm water and dry immediately to avoid water spots. To polish and help prevent fingerprints, follow with Stainless Steel Magic Spray (part no. 20000008*).
Door Gaskets	Abrasive or harsh cleaners Metal or plastic-textured scouring pads	Use warm, soapy water and a soft, clean cloth or sponge.
Condenser Coil <i>Remove base grille to access.</i>	Anything other than a vacuum cleaner	Use a vacuum cleaner hose nozzle.
Condenser Fan Outlet Grille <i>See back of refrigerator.</i>		Use a vacuum cleaner hose nozzle with brush attachment.
Accessories <i>Shelves, buckets, drawers, etc.</i>	A dishwasher	Follow removal and installation instructions from appropriate feature section. Allow items to adjust to room temperature. Dilute mild detergent and use a soft, clean cloth or sponge for cleaning. Use a plastic bristle brush to get into crevices. Rinse surfaces with clean, warm water. Dry glass and clear items immediately to avoid spots.



Care and Cleaning

Removing Odors From Refrigerator

⚠ WARNING

To avoid electrical shock which can cause severe personal injury or death, disconnect power to refrigerator *before* cleaning. After cleaning, reconnect power.

1. Remove all food and turn the refrigerator **OFF**.
2. Disconnect power to the refrigerator.
3. Clean the walls, floor, ceiling of cabinet interior, drawers, shelves and gaskets according to the instructions on page 13.
4. Dilute mild detergent and brush solution into crevices using a plastic bristle brush. Let stand for five minutes. Rinse surfaces with warm water. Dry surfaces with a soft, clean cloth.
5. Wash and dry all bottles, containers and jars. Discard spoiled or expired items.
6. Wrap or store odor-causing foods in tightly sealed containers to prevent recurring odors.
7. Reconnect power to refrigerator and return food to refrigerator.
8. Allow the refrigerator to cool.
9. After 24 hours, check if odor has been eliminated.

If odor is still present:

1. Remove drawers and place on top shelf of refrigerator.
2. Pack refrigerator and freezer sections – including doors – with crumpled sheets of black and white newspaper.
3. Place charcoal briquettes randomly on crumpled newspaper in both freezer and refrigerator compartments.
4. Close doors and let stand 24 to 48 hours.

Energy Saving Tips

- Avoid overcrowding refrigerator shelves. This reduces air circulation around food and causes refrigerator to run longer.
- Avoid adding too much warm food to refrigerator at one time. This overloads compartments and slows rate of cooling.
- **Do not** use aluminum foil, wax paper, or paper toweling as shelf liners. This decreases air flow and causes refrigerator to run less efficiently.
- A freezer that is two-thirds full runs most efficiently.
- Locate refrigerator in coolest part of room. Avoid areas of direct sunlight, or near heating ducts, registers or other heat producing appliances. If this is not possible, isolate exterior by using a section of cabinet.
- Clean door gaskets every three months according to cleaning instructions. This will assure that door seals properly and refrigerator runs efficiently.
- Take time to organize items in refrigerator to reduce time that door is open.
- Be sure your doors are closing securely by leveling refrigerator as instructed in your installation instructions.
- Clean condenser coils as indicated in the cleaning instructions every three months. This will increase energy efficiency and cooling performance.



Care and Cleaning

Replacing Light Bulbs

⚠ WARNING

To avoid electrical shock which can cause severe personal injury or death, disconnect power to refrigerator *before* replacing light bulb. After replacing light bulb, reconnect power.

⚠ CAUTION

To avoid personal injury or property damage, observe the following:

- Allow light bulb to cool.
- Wear gloves when replacing light bulb.

Fresh Food Section (style of light shield varies)

1. Slide clear light shield toward back of compartment to release from light assembly.
2. Remove light bulbs.
3. Replace with appliance bulbs **no greater than 40 watts**.
4. Replace light shield by aligning edge of shield with control housing. Slide shield toward front of refrigerator until it locks into place on 'T' shape locking tab. **Do not** force shield beyond locking point. Doing so may damage light shield.

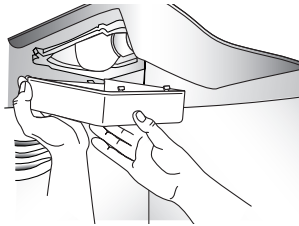

Freezer (style of light shield varies)

1. Reach behind the light cover.
2. With firm pressure, press forward on the notches at the back of the cover and pull down. The cover will open from the back.
3. Remove the cover.
4. Remove light bulb.
5. Replace bulb with appliance bulb **no greater than 40 watts**.
6. Insert front tabs of light cover into slots in freezer liner and snap rear portion over light assembly until rear tab engages.

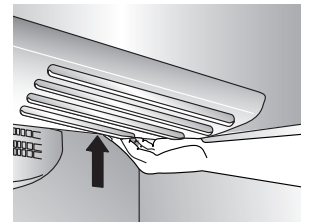
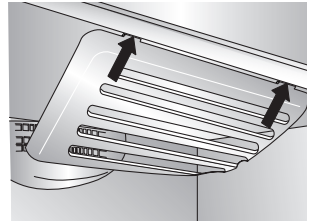
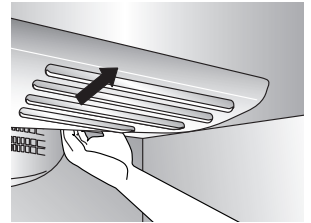



Care and Cleaning

Preparing for Vacation

⚠ CAUTION

If your refrigerator has a dispenser and there is any possibility that the temperature can drop below freezing where the refrigerator is located, the water supply system (including the water tank and the water valve) must be drained by a qualified servicer.

For short vacations or absences (three months or less):

1. Remove all perishables.
2. If no one will be checking in on the refrigerator during your absence, remove all frozen items also.
3. If your refrigerator has an automatic ice maker:
 - Shut off the water supply to the ice maker at least one day ahead of time.
 - After the last load of ice drops, raise the wire shut off arm to the **OFF** position.
 - Empty the ice bin.
4. If the room temperature will drop below 13° C, follow the instructions for longer absences.

For long vacations, absences (more than three months) OR if the room temperature will drop below 13° C:

1. Remove food.
2. If your refrigerator has an automatic ice maker:
 - Shut off the water supply to the ice maker at least one day ahead of time.
 - After the last load of ice drops, raise the wire shut off arm to the **OFF** position.
 - Empty the ice bin.
3. Turn the Freezer control to **OFF**.
4. Unplug the refrigerator.
5. Thoroughly clean the interior of both compartments with a baking soda solution and a clean, soft cloth (four tablespoons of baking soda in one quart of warm water).
6. Dry thoroughly.
7. Leave the doors open to prevent the formation of mold and mildew.

Upon your return:

After a short vacation or absence:

For models with automatic ice makers:

- Reconnect the water supply and turn on supply valve.
- Monitor water connection for 24 hours and correct leaks if necessary.
- Restart the ice maker.
- Discard at least the first *three* ice harvests.

After a long vacation or absence:

- If your refrigerator has an automatic ice maker, reconnect the water supply and turn on supply valve.
- Plug the refrigerator back in and reset controls (see page 8).
- Monitor water connection for 24 hours and correct leaks, if necessary.
- Restart the ice maker.
- Discard ice produced within the first 12 hours (at least the first *three* harvests).

Preparing to move:

- Follow the above instructions for long vacations/absences, through step 6.
- Secure all loose items such as shelves and drawers by taping them securely in place to prevent damage.
- Tape the doors shut.
- Use an appliance dolly when moving the refrigerator. **ALWAYS** truck the refrigerator from its side or back - **NEVER** from its front.
- Be sure the refrigerator stays in an upright position during moving.

Operating Sounds

Improvements in refrigeration design may produce sounds in your new refrigerator that are different or were not present in an older model. These improvements were made to create a refrigerator that is better at preserving food, is more energy efficient, and is quieter overall. Because new refrigerators run quieter, sounds may be detected that were present in older refrigerators, but were masked by higher sound levels. Many of these sounds are normal. Please note that the surfaces adjacent to a refrigerator, such as hard walls, floors and cabinetry may make these sounds seem even louder. The following are some of the normal sounds that may be noticed in a new refrigerator.

SOUND	POSSIBLE CAUSE	SOLUTION
Clicking	• Freezer control (A) clicks when starting or stopping compressor.	• Normal operation
	• Motorized device (B) sounds like an electric clock and snaps in and out.	• Normal operation
Air rushing or whirring	• Freezer fan (C) and condenser fan (D) make this noise while operating.	• Normal operation
Gurgling or boiling sound	• Evaporator (E) and heat exchanger (F) refrigerant makes this noise when flowing.	• Normal operation
Thumping	• Ice cubes from ice maker (select models) drop into ice bucket (G) .	• Normal operation
Vibrating noise	• Compressor (H) makes a pulsating sound while running.	• Normal operation
	• Refrigerator is not level.	• See pages 3-4 for details on how to level your refrigerator.
Buzzing	• Ice maker water valve (I) hookup (select models) buzzes when ice maker fills with water.	• Normal operation
Humming	• Ice maker (J) is in the 'on' position without water connection.	• Stop sound by raising ice maker arm to OFF position.
	• Compressor (H) can make a high-pitched hum while operating.	• Normal operation
Hissing or popping	• Defrost heater (K) hisses, sizzles or pops when operational.	• Normal operation

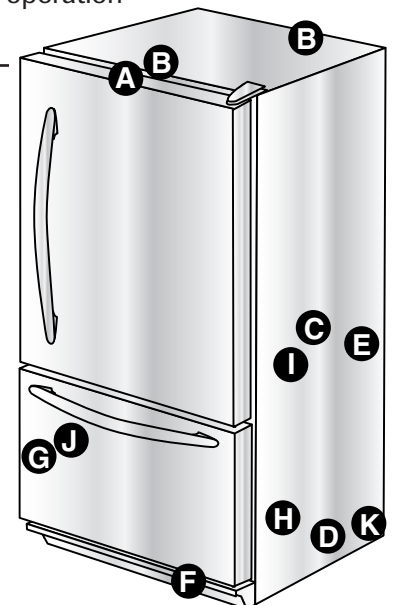



Troubleshooting

PROBLEM	POSSIBLE CAUSES	WHAT TO DO	
Freezer control and lights are on, but compressor is not operating	Refrigerator is in defrost mode.	Normal operation. Wait 40 minutes to see if refrigerator restarts.	
Crisper drawer temperature is too warm	Control settings are too low.	See page 7 to adjust controls.	
Refrigerator does not operate	Refrigerator is not plugged in.	Plug in refrigerator.	
	Control is not on.	See page 7 to adjust your controls.	
	Fuse is blown, or circuit breaker needs to be reset.	Replace any blown fuses. Check circuit breaker and reset, if necessary.	
	Power outage has occurred.	Call local power company listing to report outage.	
Refrigerator still won't operate	Refrigerator is malfunctioning.	Unplug refrigerator and transfer food to another refrigerator. If another refrigerator is not available, place dry ice in freezer section to preserve food. Warranty does not cover food loss. Contact service for assistance.	
Food temperature is too cold	Condenser coils are dirty.	Clean according to the chart on page 13.	
	Refrigerator or freezer controls are set too high.	See page 8 to adjust your controls.	
Food temperature is too warm	Door is not closing properly.	Refrigerator is not level. See page 3 for details on how to level your refrigerator. Check gaskets for proper seal. Clean, if necessary, according to the chart on page 13. Check for internal obstructions that are keeping door from closing properly (i.e. improperly closed drawers, ice buckets, oversized or improperly stored containers, etc.)	
	Controls need to be adjusted.	See page 8 to adjust your controls.	
	Condenser coils are dirty.	Clean according to the chart on page 13.	
	Rear air grille is blocked.	Check the positioning of food items in refrigerator to make sure grille is not blocked. Rear air grilles are located under crisper drawers.	
	Door has been opened frequently, or has been opened for long periods of time.	Reduce time door is open. Organize food items efficiently to assure door is open for as short a time as possible.	
	Food has recently been added.	Allow time for recently added food to reach refrigerator or freezer temperature.	
	Refrigerator has an odor	Compartment is dirty or has odor-causing food.	Clean according to instructions on page 14.
	Water droplets form on outside of refrigerator	Check gaskets for proper seal.	Clean according to the chart on page 13.
Humidity levels are high.		Normal during times of high humidity.	
Controls require adjustment.		See page 7 to adjust your controls.	



Troubleshooting

PROBLEM	POSSIBLE CAUSES	WHAT TO DO	
Water droplets form on inside of refrigerator	Humidity levels are high or door has been opened frequently.	See page 8 to adjust your controls. Reduce time door is open. Organize food items efficiently to assure door is open for as short a time as possible.	
	Check gaskets for proper seal.	Clean, if necessary, according to the chart on page 13.	
Refrigerator or ice maker makes unfamiliar sounds or seems too loud	Normal operation.	See page 17.	
Crisper drawers do not close freely	Contents of drawer, or positioning of items in the surrounding compartment could be obstructing drawer.	Reposition food items and containers to avoid interference with the drawers.	
	Drawer is not in proper position.	See page 10 for proper drawer placement.	
	Refrigerator is not level.	See page 3 for details on how to level your refrigerator.	
	Drawer channels are dirty or need treatment.	Clean drawer channels with warm, soapy water. Rinse and dry thoroughly. Apply a thin layer of petroleum jelly to drawer channels.	
Refrigerator runs too frequently	Doors have been opened frequently or for long periods of time.	Reduce time door is open. Organize food items efficiently to assure door is open for as short a time as possible. Allow interior environment to adjust for period the door has been opened.	
	Humidity or heat in surrounding area is high.	Normal operation.	
	Food has recently been added.	Allow time for recently added food to reach refrigerator or freezer temperature.	
	Refrigerator is exposed to heat by environment or by appliances nearby.	Evaluate your refrigerator's environment. Refrigerator may need to be moved to run more efficiently.	
	Condenser coils are dirty.	Clean, if necessary, according to the chart on page 13.	
	Controls need to be adjusted.	See page 8 to adjust your controls.	
	Door is not closing properly.	Refrigerator is not level. See page 3 for details on how to level your refrigerator.	
		Check gaskets for proper seal. Clean, if necessary, according to the chart on page 13.	
		Check for internal obstructions that are keeping door from closing properly (i.e. improperly closed drawers, ice buckets, oversized or improperly stored containers, etc.)	
	Normal Operation		See <i>Operating Sounds</i> on page 17.



Troubleshooting

Ice

PROBLEM	POSSIBLE CAUSES	WHAT TO DO
Refrigerator is leaking water	Supply tubing was used to complete water connection.	The manufacturer recommends using copper tubing for installation. Plastic is less durable and can cause leakage. The manufacturer is not responsible for property damage due to improper installation or water connection.
	Improper water valve was installed.	Check water connection procedure. Self-piercing and 0.5 cm saddle valves cause low water pressure and may clog the line over time. The manufacturer is not responsible for property damage due to improper installation or water connection.
Ice forms in inlet tube to ice maker	Water pressure is low.	Water pressure must be between 137 to 689 kpa to function properly.
	Freezer temperature is too high.	Adjust Freezer control (see page 8). Freezer is recommended to be approximately -18° C.



Notes
