

Panasonic®

Operating Instructions Blu-ray Disc™ Player / HDD Recorder Model No. **DMR-PWT520**

DIGA
High Definition



Thank you for purchasing this product.
For optimum performance and safety, please read these instructions carefully.
Please keep this manual for future reference.

- This Blu-ray Disc Player / HDD Recorder is for viewing and recording free to view channels only. It does not receive pay TV or encrypted channels.

Region management information

BD-Video: This unit can play BD-Video discs supporting the region code “B”.

e.g.,



DVD-Video: This unit can play DVD-Video discs supporting the region number “4” or “ALL”.

e.g.,



Safety precautions

WARNING

Unit

- To reduce the risk of fire, electric shock or product damage,
 - Do not expose this unit to rain, moisture, dripping or splashing.
 - Do not place objects filled with liquids, such as vases, on this unit.
 - Use only the recommended accessories.
 - Do not remove covers.
 - Do not repair this unit by yourself. Refer servicing to qualified service personnel.
 - Do not let metal objects fall inside this unit.
 - Do not place heavy items on this unit.

AC mains lead

- To reduce the risk of fire, electric shock or product damage,
 - Ensure that the power supply voltage corresponds to the voltage printed on this unit.
 - Insert the mains plug fully into the socket outlet.
 - Do not pull, bend, or place heavy items on the lead.
 - Do not handle the plug with wet hands.
 - Hold onto the mains plug body when disconnecting the plug.
 - Do not use a damaged mains plug or socket outlet.
- Install this unit so that the AC mains lead can be unplugged from the socket outlet immediately if any problem occurs.

SD card

- Keep the Memory Card out of reach of children to prevent swallowing.

CAUTION

Unit

- This unit utilizes a laser. Use of controls or adjustments or performance of procedures other than those specified herein may result in hazardous radiation exposure.
- Do not place sources of naked flames, such as lighted candles, on this unit.
- This unit may receive radio interference caused by mobile telephones during use. If such interference occurs, please increase separation between this unit and the mobile telephone.
- This unit is intended for use in moderate climates.

Placement

- Place this unit on an even surface.
- To reduce the risk of fire, electric shock or product damage,
 - Do not install or place this unit in a bookcase, built-in cabinet or in another confined space. Ensure this unit is well ventilated.
 - Do not obstruct this unit's ventilation openings with newspapers, tablecloths, curtains, and similar items.
 - Do not expose this unit to direct sunlight, high temperatures, high humidity, and excessive vibration.

Batteries

- Danger of explosion if battery is incorrectly replaced. Replace only with the type recommended by the manufacturer.
- Mishandling of batteries can cause electrolyte leakage and may cause a fire.
 - Do not mix old and new batteries or different types at the same time.
 - Do not heat or expose to flame.
 - Do not leave the battery(ies) in a car exposed to direct sunlight for a long period of time with doors and windows closed.
 - Do not take apart or short circuit.
 - Do not recharge alkaline or manganese batteries.
 - Do not use batteries if the covering has been peeled off.
 - Remove batteries if you do not intend to use the remote control for a long period of time. Store in a cool, dark place.
- When disposing the batteries, please contact your local authorities or dealer and ask for the correct method of disposal.



CAUTION	- VISIBLE AND INVISIBLE LASER RADIATION WHEN OPEN. DO NOT STARE INTO BEAM. FSA 21CFRCLASS II (IIa)
CAUTION	- CLASS 2 VISIBLE AND INVISIBLE LASER RADIATION WHEN OPEN. DO NOT STARE INTO THE BEAM. IEC60825-1/CLASS 2
ATTENTION	- RAYONNEMENT LASER VISIBLE ET INVISIBLE, CLASSE 2. EN CAS D'OUVERTURE, NE PAS REGARDER DANS LE FAISCEAU.
FORSIGTIG	- SYNLIG OG USYNLIG LASERSTRÅLING KLASSE 2. NÅR LAGET ER ÅBENT, UNDGÅ AT SE LIGE IND I STRÅLEN.
VARO	- AVATTAESSA OLET ALLTIINA LUOKAN 2 NÄKYVÄÄ JA NÄKYMÄTÖNTÄ LASERSÄTEILYÄ, ÄLÄ TUJOTA SÄTEESEEN.
VARNING	- KLASSE 2 SYNLIG OCH OSYNLIG LASERSTRÅLNING NÄR DENNA DEL ÄR ÖPPNAD. STIPRA EJ IN I STRÅLEN.
VORSICHT	- SICHTBARE UND UNSICHTBARE LASERSTRÄHLUNG KLASSE 2. WENN ABDECKUNG GEÖFFNET, NICHT IN DEN STRAHL BLICKEN.
注意	- 打开时有可见及不可见激光辐射。避免光束照射。
注意	- ここを開くとクラス2の可視及び不可視レーザー放射が出る ビームをのぞきまなないこと VQL2P54

(Inside of product)

Supplied accessories

Please check and identify the supplied accessories.

(Product numbers correct as of February 2012. These may be subject to change.)

Remote control (N2QAYB000757):	1 pc.
Batteries for remote control:	2 pcs.
AC mains lead:	1 pc.
RF coaxial cable:	1 pc.
Audio/Video cable:	1 pc.

- Do not use AC mains lead with other equipment.

Indemnity concerning recorded content

Panasonic does not accept any responsibility for damages directly or indirectly due to any type of problems that result in loss of recording or edited content (data), and does not guarantee any content if recording or editing does not work properly. Likewise, the above also applies in a case where any type of repair is made to the unit (including any other non-HDD related component).

Restriction on use of unauthorized copied content

This unit adopts the following technology for copyright protection.

Cinavia Notice

This product uses Cinavia technology to limit the use of unauthorized copies of some commercially-produced film and videos and their soundtracks. When a prohibited use of an unauthorized copy is detected, a message will be displayed and playback or copying will be interrupted. More information about Cinavia technology is provided at the Cinavia Online Consumer Information Center at <http://www.cinavia.com>. To request additional information about Cinavia by mail, send a postcard with your mailing address to: Cinavia Consumer Information Center, P.O. Box 86851, San Diego, CA, 92138, USA.

Table of contents

Safety precautions	2
Supplied accessories	3
Getting started	
HDD and media information	6
- Recordable/playable contents	6
- Notes	8
Unit care	10
Control reference guide	11
Connection	13
- Basic connections	13
- Other TV connections	14
- Amplifier/receiver connections	15
- Network connection	17
Settings	18
- TV operation buttons	18
- Easy Setting	19
- Easy Network Setting	20
FUNCTION MENU screen	22
Watching broadcasts	
Watching broadcasts	23
- Using Channel List	23
- Using TV Guide system	24
- Using channel information	24
- Operations while watching broadcast	25
- REWIND LIVE TV/PAUSE LIVE TV	25
Recording	
Recording TV programmes	27
- Operation during Recording	28
Timer recording	29
- Manually programming timer recording	30
- Timer recording options	30
- Timer recording from channel information	31
- Notes on timer recording	31
- To confirm and edit a timer programme	32
Playing back video	
Playing titles on the HDD	33
- DIRECT NAVIGATOR (VIDEO) screen	33
Playing titles on the media	36
- Notes for BD-Live discs	37
Operation during play	38
- General operations	38
- 3D video playback	40
Editing video	
Deleting recorded titles	42
Editing recorded titles	43
Copying video	
Copying titles	46
Photo	
Playing photos	48
- DIRECT NAVIGATOR (PHOTO) screen	48
- Photo play option	49
- Slideshow Settings	49
Editing photos	50
Copying photos	51
- Selecting and copying the photos	51
- Copying automatically	51
Music	
Playing music	52
- Copying music to HDD	52
- Playing music recorded on HDD	53
- Operations during music play	54
Editing music/playlist	55
With Other Equipment	
Copying the HD Video or the SD Video	56
- Copying HD Video (AVCHD format)	56
- Copying SD Video (MPEG2 format)	57
DLNA functions	58
- Using this unit as Server	58
- Using this unit as Client	59
- Using this unit as Media Renderer	60
Convenient functions	
Format SD card	61
Registering the external HDD (USB HDD)	62
- Connecting the USB HDD	62
- Disconnecting the USB HDD	62
- Registering the USB HDD	63
VIERA Link functions	64
VIERA Connect (Enjoying Internet Service)	65
- To enjoy video communication (e.g., Skype™)	65
Playback menu	66

- Changing the unit's settings 68
 - Common procedures 68
 - Digital TV Tuning 70
 - HDD / Disc / USB HDD 72
 - Picture 74
 - Sound 75
 - Display 76
 - Connection 76
 - Network 78
 - Others 79
 - Language code list 81
- Software (Firmware) Update 82
- Other operations 83
 - Entering text 83
 - Switching the aspect ratio of the screen 83
 - HOLD function 83

About descriptions in these operating instructions

- Pages to be referred to are indicated as "⇒ ○○".

Troubleshooting

- Troubleshooting guide 84
 - General operation 84
 - Displays 85
 - TV screen and video 85
 - Sound 86
 - Recording, timer recording and copying 86
 - Play 86
 - Edit 87
 - Photo 87
 - USB 87
 - TV Guide 87
 - Broadcast 88
 - VIERA Link 88
 - Network 88
 - Reset 89
 - Messages on the unit's display 89
 - When you experience problems with Easy Network Setting 91

Reference

- Specifications 93
- Licenses 97
- Limited Warranty 100
- Index 101

Getting started

Watching broadcasts

Recording

Playing back video

Editing video

Copying video

Photo

Music

With Other Equipment

Convenient functions























Troubleshooting

Reference









HDD and media information

Recordable/playable contents

(-: Impossible)

Media type	Standard symbol		Playable contents	Recordable contents
Built-in hard disk drive (HDD)			<ul style="list-style-type: none"> • Video • AVCHD • JPEG • MPO • MP3 	
External HDD (⇔ 62)*1, 2			<ul style="list-style-type: none"> • Video 	
BD-Video 			<ul style="list-style-type: none"> • Video 	-
BD-RE 			<ul style="list-style-type: none"> • Video • AVCHD • JPEG • MPO 	-
BD-R 			<ul style="list-style-type: none"> • Video • AVCHD*3 • DivX® • MKV 	-
DVD-Video*4 			<ul style="list-style-type: none"> • Video 	-
DVD-R DVD-R DL  			<ul style="list-style-type: none"> • Video • DivX® • JPEG • MP3 	-
DVD-RW 			<ul style="list-style-type: none"> • Video • AVCHD*3 	
+R/+R DL			<ul style="list-style-type: none"> • Video • AVCHD*3 	-
+RW			<ul style="list-style-type: none"> • Video • AVCHD*3 	-

(-: Impossible)

Media type	Standard symbol		Playable contents	Recordable contents	
Audio CD (CD-DA) 			• Music	-	
CD (including CD-R/RW)			• DivX® • JPEG • MP3	• MKV • MPO	-
SD Cards 			• AVCHD • MPEG2*5 • MPO	• JPEG • MPO	
USB memories			• AVCHD*3,5 • MPEG2 • MKV • MPO	• MP4 • DivX® • JPEG • MP3	-

*1 Referred to as "USB HDD" in these operating instructions.

*2 It cannot be recorded directly. (Only compatible with copying from the built-in HDD)

*3 Recorded with AVCHD compatible devices (Panasonic video camera, etc.). It may not be able to play back depending on the device.

*4 Includes finalised DVD-R, DVD-R DL, DVD-RW, +R and +R DL.

*5 It cannot be played back directly from the SD card or USB memory. Playback is possible by copying to the HDD.



- **[USB]** Video images of the copyright-protected DivX contents stored on USB device can be output only through the HDMI output terminal.
- The producer of the disc can control how discs are played. So you may not always be able to control play as described in these operating instructions. Read the disc's instructions carefully.
- With certain recording states and folder structures, the play order may differ or playback may not be possible.

Playable contents on a DLNA server

When this unit works as a DLNA client (⇒ 59), following contents are playable.

- Recorded video*
- AVCHD*
- MP4
- MPEG2
- JPEG
- MPO
- MP3
- FLAC

* Only when the server is another DIGA. (⇒ 58)

• Depending on the server, the contents other than stated above can be played back.

HDD and media information

Notes

About extension of files

File format	Extension					
JPEG	“.JPG”	“.jpg”				
MPO	“.MPO”	“.mpo”				
MP3	“.MP3”	“.mp3”				
DivX	“.DIVX”	“.divx”	“.AVI”	“.avi”		
Subtitle text files*	“.SRT”	“.srt”,	“.SUB”	“.sub”,	“.TXT”	“.txt”
MKV	“.MKV”	“.mkv”				
Subtitle text files*	“.SRT”	“.srt”	“.SSA”,	“.ssa”,	“.ASS”,	“.ass”
MPEG2	“.MPG”	“.mpg”	“.MPEG”	“.mpeg”	“.M2TS”	“.m2ts”
	“.mts”	“.TS”	“.ts”			
MP4	“.MP4”	“.mp4”	“.MOV”	“.mov”		

* The video file and subtitles text file are inside the same folder, and the file names are the same except for the file extensions.

- Some files may not be played back even if they have these extensions.

Notes for the disc

• Disc recorded on a recorder, PC, etc.

- It may be necessary to finalize the disc, create Top Menu or close the session on the equipment used for recording to play on this unit.

• Discs that cannot be played

- DVD-RAM
- HD DVD
- Super Video CD, Super Audio CD, Video CD
- DVD-Audio
- WMA discs, DivX Plus HD discs
- CD-ROM, Photo CD, PD, etc.



- Operation and sound quality of CDs that do not conform to CD-DA specifications (copy control CDs, etc.) cannot be guaranteed.

Notes for the USB devices

- This unit does not guarantee connection with all USB devices.
- FAT12, FAT16 and FAT32 file systems are supported.
- This unit supports USB 2.0 High Speed.
- Although this unit can use USB 3.0 devices as USB 2.0 devices, in certain cases USB 3.0 devices cannot be used due to differing connector shape, larger current ratings, etc. (Use of USB 2.0 devices is recommended.)



- USB memories support DivX and MKV files less than 4 GB.
- When using Communication Camera (TY-CC20W or TY-CC10W), connect it to the rear terminal of this unit. (⇒ 65)

Notes for the SD cards

• Compatible SD card

- SD Memory Card
(from 8 MB to 2 GB, FAT12 and FAT16 formats)
- SDHC Memory Card
(from 4 GB to 32 GB, FAT32 format)
- SDXC Memory Card
(48 GB, 64 GB, exFAT format)

• Using miniSD card or microSD card

Mini-type and micro-type cards can also be used, but must be used with adaptor cards (optional).

To format an SD card

Refer to "Format SD card". (⇒ 61)



- Usable memory is slightly less than the card capacity.
- If the SD card is formatted on other equipment, the time necessary for recording may be longer or the card may not be able to be used on this unit. In these cases, format the card on this unit.
- SDHC Memory Cards and SDXC Memory Cards can be used in equipment that is compatible with the appropriate cards. (SDHC Memory Cards can also be used in equipment compatible with SDXC Memory Cards)

Media handling

- Do not touch the recorded surface of the discs or the terminal surface of the SD cards.



- If there is dirt or condensation on the disc, wipe with a damp cloth and then wipe dry.



- Do not attach labels or stickers to discs.
- Do not use disc cleaning sprays, benzene, thinner, static electricity prevention liquids or any other solvent.
- Do not use ballpoint pens or other hard writing implements, when writing on the label side of the disc.
- Do not drop, stack, or impact discs.
- Do not place objects on discs.
- Do not use the following discs:
 - Discs with exposed adhesive from removed stickers or labels (rental discs, etc.).
 - Discs that are badly warped or cracked.
 - Irregularly shaped discs.

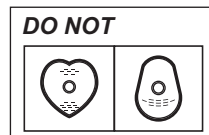

- Do not expose the terminals of the SD card to water, garbage or other strange things.
- Do not place in the following areas:
 - In hot places, such as under the direct sunlight.
 - In very dusty or humid areas.
 - Locations susceptible to significant difference in temperature (condensation can occur).
 - Where static electricity or electromagnetic waves occur.

Unit care

HDD/USB HDD handling care

- **The HDD is a high precision device**
The HDD is a high precision recording instrument and is easily susceptible to damage. Therefore, be careful of the following points while the unit is turned on, especially during operation, otherwise the HDD and the recorded content may be damaged:
 - Do not subject the unit to any vibration and shock.
 - Do not remove the AC mains lead from the household mains socket.
- **The HDD is a temporary storage device**
This unit cannot save (backup) the HDD titles to media. You have to be very careful when handling the unit and editing the title.
- **If the HDD or USB HDD is damaged, the recorded content cannot be recovered.**

Setup precautions

- **Place the unit on a surface that is flat and not subject to vibration or impact.**
- **Do not place on anything that generates heat like a Set Top Box, etc.**
- **Place in an area where condensation does not occur. Conditions where condensation may occur**
 - When there is an extreme change in temperature (e.g., when subjected to an air conditioner or when cooled air directly impacts the unit).
 - When there is high humidity or a lot of steam in the room.

In the above situation, **without turning the unit on**, let the unit adjust to the room temperature and wait 2–3 hours until condensation is gone.
- **Do not block the cooling fan on the rear of the unit.**
- **The unit may breakdown if cigarette smoke or bug spray/vapour, etc. gets inside the unit.**

When moving the unit

Before moving the unit, ensure the disc tray is empty.

- 1 Switch the unit to standby mode. (Wait until "BYE" disappears from the display.)
- 2 Remove the AC mains lead from the household mains socket.
- 3 Move only after the unit has come to a complete stop (approx. 3 minutes) in order to avoid subjecting to vibration and shock. (Even after the unit is switched to standby mode, the HDD continues operating for a short time.)

Cleaning

- **This unit**
 - Wipe with a soft, dry cloth.
 - Never use alcohol, paint thinner or benzine to clean this unit.
 - Before using chemically treated cloth, carefully read the instructions that came with the cloth.
- **This unit's lens**
Use the **Lens cleaner** (optional) to clean the unit's lens.

Lens cleaner: RP-CL720AE

- This lens cleaner may not be for sale depending on the region.

When requesting this unit for repair

The registration of the USB HDD may be cancelled in the process of repairing this unit. You can use the USB HDD again by re-registering, but all recorded content already on the USB HDD will be lost. In such cases, the recorded content (data) cannot be recovered.

Control reference guide

Instructions for operations are generally described using the remote control.

Remote control

- ① Transmit the remote control signal
 - Point it at remote control signal sensor on this unit. (⇒ 12)
- ② Switch the unit from on to standby mode or vice versa
- ③ Select drive (HDD, BD, SD or USB)
- ④ Select channels and title numbers, etc./Enter numbers or characters
- ⑤ Switch to the previously watched channel (⇒ 23)
- ⑥ Basic operations for recording and play, REWIND LIVE TV/PAUSE LIVE TV (⇒ 25)
- ⑦ Show Information (⇒ 24, 34, 38)
- ⑧ Selection/OK, Frame-by-frame (⇒ 39)
- ⑨ Show DIRECT NAVIGATOR, Top Menu, Pop-up Menu (⇒ 33, 39)
- ⑩ Show OPTION menu (⇒ 43, 50, 55)
- ⑪ Colour buttons (Use in accordance with instruction on the screen.)
- ⑫ Start recording (⇒ 27)
- ⑬ Select audio (⇒ 25, 40)
- ⑭ Show the Timer Recording screen (⇒ 30)
- ⑮ Create chapter (⇒ 39)
- ⑯ Show Setup menu (⇒ 68)
- ⑰ To delete unwanted recorded titles, timer programmes, photos or music (⇒ 42)
- ⑱ TV operation buttons (⇒ 18)
- ⑲ Channel select (⇒ 23)/Change pages in the DIRECT NAVIGATOR screen etc.
- ⑳ Show the VIERA Connect screen (⇒ 65)
- ㉑ Switching to the radio channel list (⇒ 23)
- ㉒ Start up a video communication (⇒ 65)
- ㉓ Exit the menu screen
- ㉔ Show the TV Guide screen (⇒ 24)
- ㉕ Show the FUNCTION MENU screen (⇒ 22)
- ㉖ Return to previous screen
- ㉗ Show subtitles (⇒ 25, 40)
- ㉘ Show Teletext (⇒ 25)
- ㉙ Show Playback Menu (⇒ 66)
- ㉚ Skip the specified time (⇒ 39)
- ㉛ Skip approx. 1 minute forward (⇒ 39)
- ㉜ Skip approx. 10 seconds backward (⇒ 39)

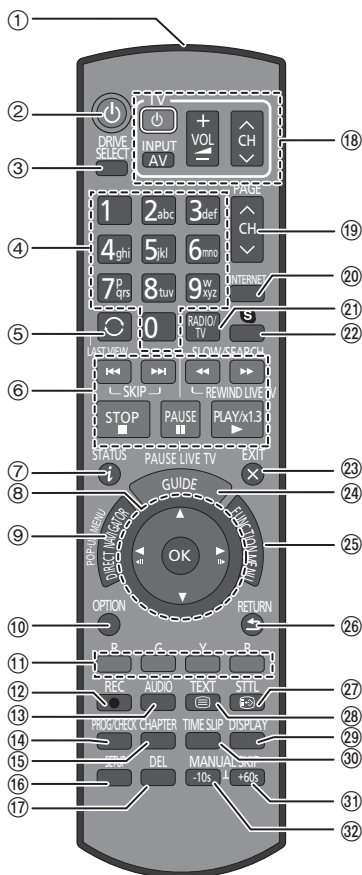

Insert batteries

Insert so the poles (+ and -) match those in the remote control.

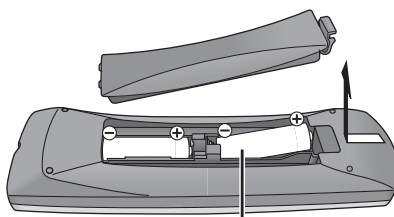

R6/LR6, AA
(Alkaline or manganese batteries)

Control reference guide

Main unit

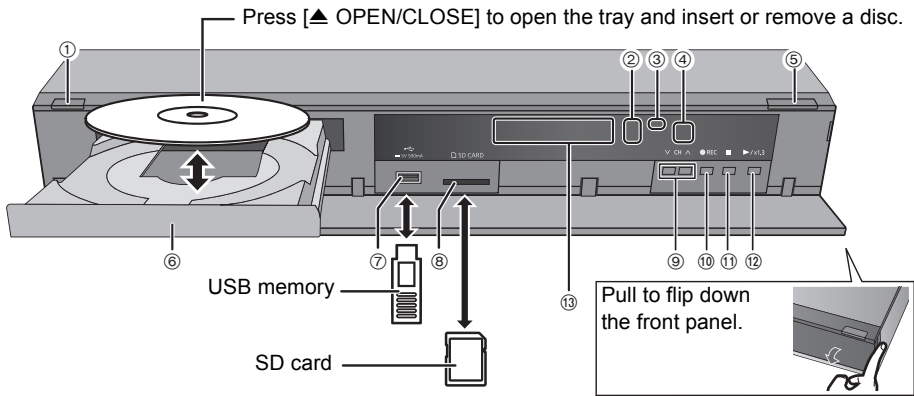

① Standby/on switch (⏻/⏻)

Press to switch the unit from on to standby mode or vice versa. In standby mode, the unit is still consuming a small amount of power.

② Recording indicator

- The indicator will light up while recording.
- The indicator will blink while recording is paused and before recording starts.

③ CALL LED

- The LED will light up when this unit receives incoming call etc. of the video communication. (⇒ 65)

④ Remote control signal sensor

- Angle: Approx. 20° up and down, 30° left and right
- Distance: Within approx. 7 m in front of the unit

⑤ Open/close disc tray

⑥ Disc tray

⑦ USB port

⑧ SD card slot

- When removing the SD card, press on the centre of the card and pull it straight out.

⑨ Channel select (⇒ 23)

⑩ Start recording (⇒ 27)

⑪ Stop

⑫ Start play

⑬ Display

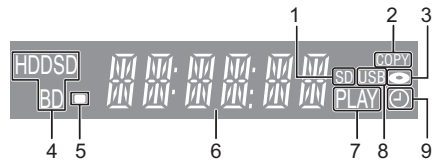

1 SD card slot indicator

2 Copying indicator

3 Disc indicator

4 Drive (HDD, BD or SD) indicator

5 Remote control signal indicator

6 Main display section indicator

- Current time
- Playback counter
- Various messages (⇒ 89)

7 Playback indicator

8 USB port indicator

9 Timer recording indicator

- This indicator lights up when the timer recording standby is activated.



• While writing to/reading from the media, do not switch the unit to standby mode or remove the media. Such action may result in loss of the media contents.

• When inserting the media, ensure that it is facing the right way up.

Connection

Basic connections

3D programmes can be played back when this unit is connected to a 3D compatible TV.

- Before connection, turn off all equipment and read the appropriate operating instructions.

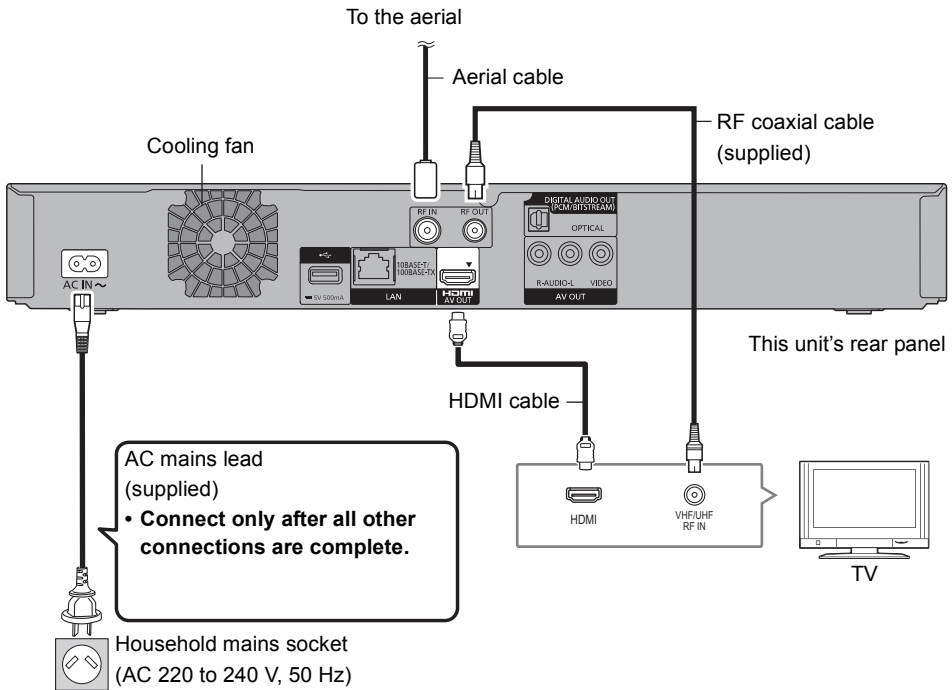

If the TV does not have the HDMI terminal

Connect the TV with the Audio/Video cable. (⇒ 14)

To connect and register the USB HDD (optional)

Refer to "Registering the external HDD (USB HDD)". (⇒ 62)

To connect the Communication Camera (optional)

Refer to "VIERA Connect (Enjoying Internet Service)". (⇒ 65)

About HDMI cable

- Use the High Speed HDMI cables. Non-HDMI-compliant cables cannot be utilized.
- When outputting 1080p signal, please use HDMI Cables 5.0 meters or less.
- Recommended Panasonic HDMI cable part number:
RP-CDHS15 (1.5 m), RP-CDHS30 (3.0 m), RP-CDHS50 (5.0 m), etc.

Connection

When the unit is not to be used for a long time

To save power, unplug it from the household mains socket. This unit consumes a small amount of power, even when the unit is in standby mode.

[approx. 0.2 W (“Power Save in Standby” is activated and “RF OUT (Aerial Signal)” is set to “Off”)]



- The HDMI connection supports VIERA Link “HDAVI Control” (⇒ 64).
- You cannot connect this unit to DVI devices that are incompatible with HDCP. Depending on the device, images may not display properly or at all when connecting with a DVI/HDMI switching cable. (Audio cannot be output.)
- If you are connecting to a TV that is only compatible with 2 channel audio output, audio with 3 channels or more will be down mixed and output as 2 channels, even if connecting with an HDMI cable. (Some discs cannot be down mixed.)

Other TV connections

- Connect to terminals of the same colour.

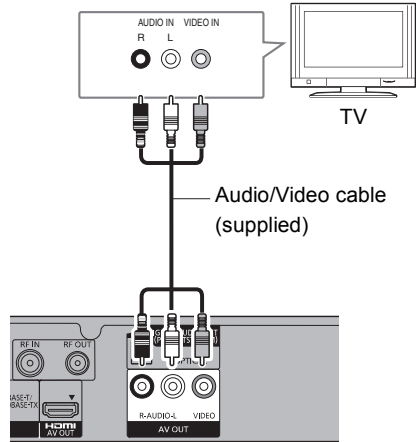

- 3D video playback is not possible with this connection.
- Do not connect video signals through a video recorder. Due to copy guard protection the picture may not be displayed properly.

Amplifier/receiver connections

HDMI terminal

3D programmes can be played back when this unit is connected to a 3D compatible amplifier/receiver and a 3D compatible TV.

- You will not be able to view 3D programmes with this connection if your amplifier/receiver is not 3D compatible.

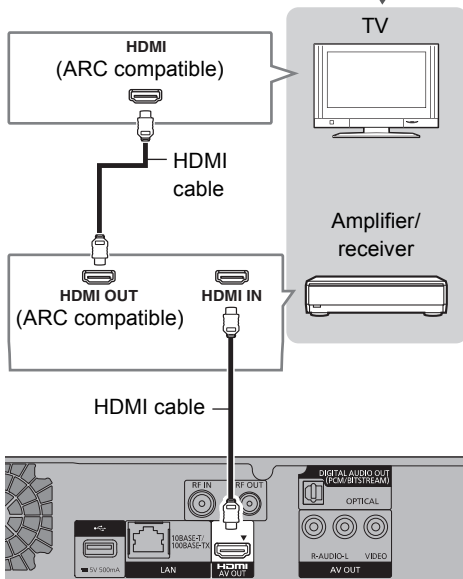

- VIERA Link function is possible by connecting to a TV or amplifier/receiver compatible with VIERA Link.
- When using a TV or an amplifier/receiver that does not display "ARC compatible" on the HDMI terminal, it is necessary to connect the TV and the amplifier/receiver with a digital audio cable to enjoy the TV audio on the amplifier/receiver.

Amplifier/receiver not compatible with 3D

3D programmes can be played back when this unit is connected to a 3D compatible TV.

- This connection only supports up to 5.1ch.

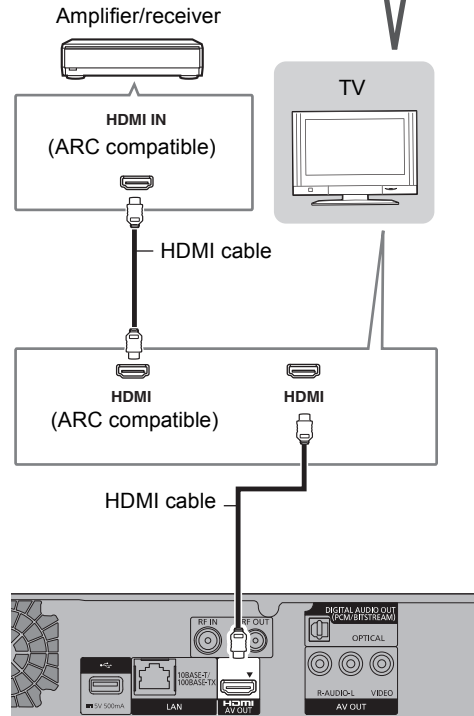

- VIERA Link function is possible by connecting to a TV or amplifier/receiver compatible with VIERA Link.
- When using a TV or an amplifier/receiver that does not display "ARC compatible" on the HDMI terminal, it is necessary to connect the TV and the amplifier/receiver with a digital audio cable to enjoy the TV audio on the amplifier/receiver.

Connection

DIGITAL AUDIO OUT terminal

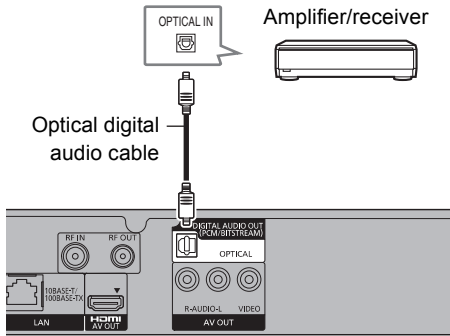

- When you do not want the audio to be output from the TV, set "HDMI Audio Output" to "Off" (⇒ 68, 77).

AUDIO OUT terminal

- Connect to terminals of the same colour.

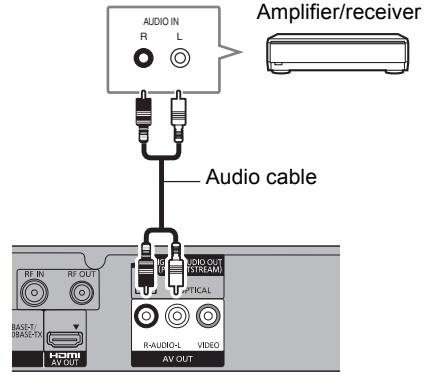

Network connection

Following functions will be available when this unit is connected to the network.

- Home network (DLNA) (⇒ 58)
- VIERA Connect (Enjoying Internet Service) (⇒ 65)
- BD-Live functions with Internet (⇒ 37)
- Updating the software (firmware) of this unit from Internet (⇒ 82)

For details about connection method, refer to the instructions supplied with the connected equipment.

LAN cable connection

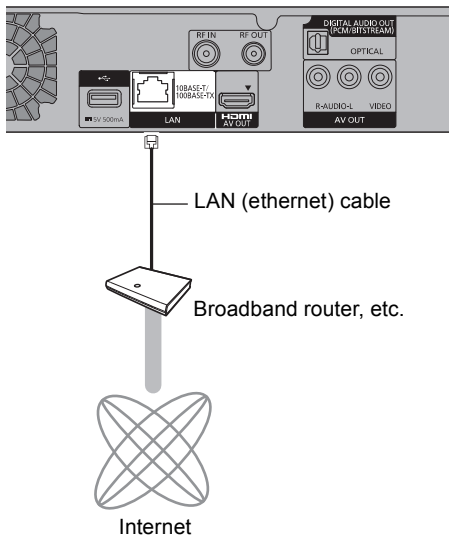

- Use category 5 or above straight LAN cables (STP) when connecting to peripheral devices.
- Inserting any cable other than a LAN cable in the LAN terminal can damage the unit.

Wireless LAN connection

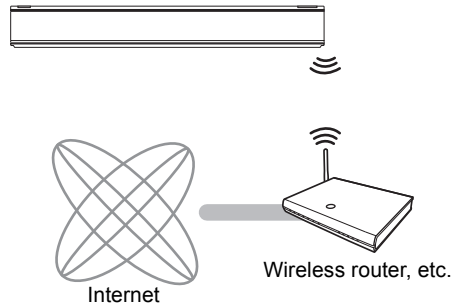

- For up-to-date compatibility information on your Wireless router refer to <http://panasonic.jp/support/global/cs/> (This site is in English only.)
- The unit is not compatible with public wireless LAN services.

■ Precautions of Wireless LAN connection

The following limits are in place regarding the usage of this unit. You must be aware of these limits before using this unit.

Panasonic will in no way be responsible for any incidental damage which may arise due to a failure to obey these limits, or to any condition of use or disuse of this unit.

- **Data transmitted and received over radio waves may be intercepted and monitored.**
- **This unit contains delicate electronic components.**

Please use this unit in the manner in which it was intended and follow the following points:

- Do not expose this unit to high temperatures or direct sunlight.
- Do not bend, or subject this unit to strong impacts.
- Keep this unit away from moisture.
- Do not disassemble or alter this unit in any way.

Settings

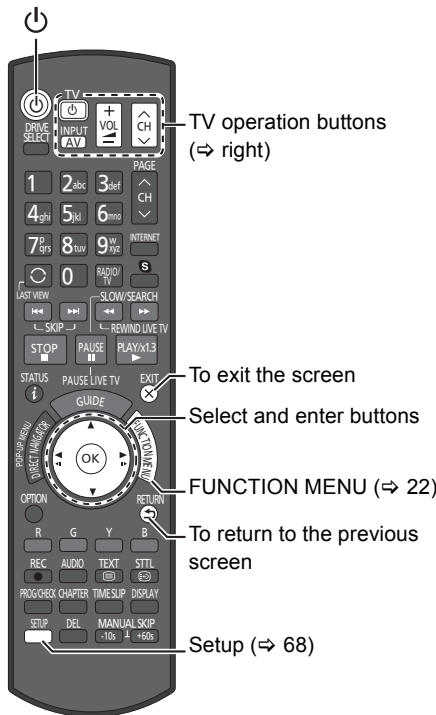

TV operation buttons

The TV can be operated from the TV operation buttons of the remote control.

- Perform the setting if you cannot operate the TV with the TV operation buttons.

While pressing [TV ⏻], enter the code with the number buttons.

Manufacturer and Code No.

Brand	Code	Brand	Code
Panasonic	01/02/03/04	NEC	36
AIWA	35	NOBLEX	33
AKAI	27/30	NOKIA	25/26/27/60/61
BEKO	05/71/72/73/74	NORDMENDE	10
BENQ	58/59	OLEVIA	45
BRANDT	10/15	ONWA	30/39/70
BUSH	05	ORION	05
CENTREX	66	PEONY	49/69
CURTIS	05	PHILCO	41/48/64
DAEWOO	64/65	PHILIPS	05/06/46
DESMET	05	PHONOLA	05
DUAL	05	PIONEER	37/38
ELEMIS	05	PROVIEW	52
FERGUSON	10/34	PYE	05
FINLUX	61	RADIOLA	05
FISHER	21	SABA	10
FUJITSU	53	SALORA	26
FUNAI	63/67	SAMSUNG	32/42/43/65/68
GOLDSTAR	05/50/51	SANSUI	05
GOODMANS	05	SANYO	21/54/55/56
GRADIENTE	36	SCHNEIDER	05/29/30
GRUNDIG	09	SEG	05/69/75/76/77/78
HITACHI	05/22/23/40/41	SELECO	05/25
IRRADIO	30	SHARP	18
ITT	25	SIEMENS	09
JVC	17/30/39/70	SINUDYNE	05
KDS	52	SONY	08
KOLIN	45	TCL	31/33/66/67/69
KONKA	62	TELEFUNKEN	10/11/12/13/14
LG	05/50/51	TEVION	52
LOEWE	07/46	THOMSON	10/15/44
MAG	52	TOSHIBA	16/57
METZ	05/28/79	WHITE	05
MITSUBISHI	05/19/20/47	WESTINGHOUSE	
MIVAR	24	YAMAHA	18/41

- If the brand of your TV is not listed or the code number is invalid for the TV, this remote control is not compatible with your TV.



- If your TV brand has more than one code listed, select the one that allows correct operation.

Easy Setting

- 1 Turn on the TV, then select the appropriate AV input to suit the connections to this unit.
- 2 Press [⏻] on the remote control or [⏻/I] on this unit.
 - The Easy Setting will start at the initial power on.
- 3 Follow the on-screen instructions and make the settings.
 - When the Download from TV screen appears, the setting information on the TV is acquired by this unit. (⇒ 64)
 - When the Auto Setup screen appears, the unit searches for the terrestrial digital channels. It takes about 3 minutes.

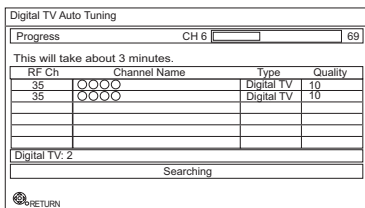

After tuning has been completed, clock will be set automatically.

If the clock setting screen appears, set the time manually (⇒ 80, Clock).

- 4 Set "Power Save" to "On", "On Timer" or "Off", then press [OK].

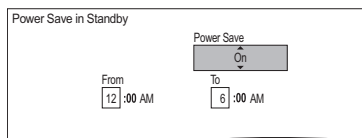

- **On**
It will go into the Power Save in Standby mode.
- **On Timer**
Set the start and stop time and then press [OK].
 - "Power Save in Standby" is activated when the set time comes.
- **Off**
It is possible to start quickly from standby mode. (Quick Start mode)
 - If you use Home Network function (⇒ 79), select "Off". This function is not available with other settings.

When "Easy Setting has been completed." appears, Easy Setting is complete.

To stop partway

Press [RETURN ⊖].

To restart setup

- 1 Press [SETUP]. (⇒ 18)
- 2 Select "Auto Setup" in "Digital TV Tuning", then press [OK].
- 3 Select "Yes", then press [OK].

If the TV aspect setting screen appears

Refer to "TV Aspect". (⇒ 76)

To confirm that channels have been tuned correctly

Refer to "Using Channel List". (⇒ 23)



- If tuning is cancelled partway through, it may not be possible to receive the channels. Restart setup again.

Settings

Easy Network Setting

After completing “Easy Setting”, you can continue with “Easy Network Setting”.

Preparation

- Before beginning wireless connection setup Obtain your Network name (SSID).
An SSID (Service Set Identification) is a name used by wireless LAN to identify a particular network. Transmission is possible if the SSID matches for both devices.

- 1 Select “Wired” or “Wireless”, then press [OK].

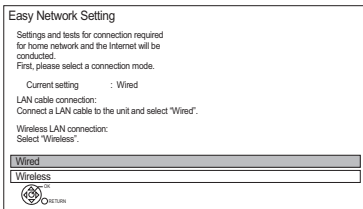

- 2 Follow the on-screen instructions and make the following confirmation and settings.

“Wired” connection:

- Home Network Connection Check
- Home Network function
- Internet Connection Test

“Wireless” connection:

- Select a connection method to wireless access point. (⇒ right)
- Wireless Settings
- Home Network Connection Check
- Internet Connection Test

- 3 When “Easy Network Setting have been finished.” appears. Press [OK].

Connection method to wireless access point

Search for wireless network:

- 1 Select “Search for wireless network”, then press [OK].
- 2 The available wireless networks will be displayed. Select your network name and press [OK].
 - If your Network name is not displayed search again by pressing the red button on the remote control.
 - Stealth SSID will not be displayed. Enter manually by using “Wireless Settings”. (⇒ 68, 78)

- If your wireless network is encrypted, Encryption Key Input Screen will be displayed. Input the encryption key of your network.

WPS (PUSH button):

If your Wireless router supports WPS (PUSH button), you can easily perform the settings by pressing WPS button on it.

WPS (Wi-Fi Protected Setup™) is a standard that facilitates settings relating to the connection and security of wireless LAN devices.

- 1 Select “WPS (PUSH button)”, then press [OK].
- 2 Press WPS button or corresponding button of Wireless router until the lamp starts flashing.

e.g.,

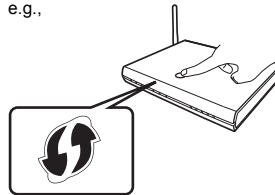

- Wi-Fi Protected Setup™-compatible Wireless router may have the mark.
 - For details, refer to the operating instruction of Wireless router.
- 3 Press [OK].

When you experience problems

Refer to "When you experience problems with Easy Network Setting". (⇒ 91)

To restart Easy Network Setting

- 1 Press [SETUP]. (⇒ 18)
- 2 Select "Easy Network Setting" in "Network", then press [OK].

To redo settings individually

If "Easy Network Setting" did not work properly or when you change the settings individually, perform the following steps.

- 1 Press [SETUP]. (⇒ 18)
- 2 Select "Network Settings" in "Network", then press [OK].
- 3 Refer to "Network Settings". (⇒ 78)

Check security before using Home Network function

If you set "Home Network function" to "On", all connected devices on the same network can access this unit. Ensure that the router for your home network has adequate security system to prevent unauthorized access.



- Refer to the operating instructions of the hub or router.
- Home Network function setting can be set only when you selected "Off" for "Power Save in Standby" in "Easy Setting". (⇒ 19, step 4)
- Even if you set "Home Network function" to "Off", it is possible to set to "On" later. (⇒ 68, 79)
- Do not use this unit to connect to any wireless network for which you do not have usage rights. During automatic searches in a wireless network environment, wireless networks (SSID) for which you do not have usage rights may be displayed; however, using these networks may be regarded as illegal access.
- After performing network settings on this unit, the settings (encryption level, etc.) of the Wireless router might change. When you have trouble getting online on your PC, perform the network settings on your PC in accordance with the settings of Wireless router.
- Please be aware that connecting to a network without encryption may result in the content of the communication being illegitimately viewed by a third party, or the leaking of data such as personal or secret information.

FUNCTION MENU screen

You can easily access the desired functions, such as playback, timer recording, the unit's settings etc. via the FUNCTION MENU.

- 1 Press [FUNCTION MENU].

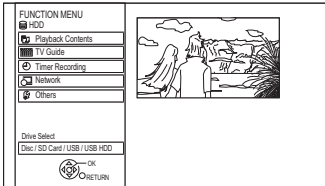

- 2 Select the item, then press [OK]

FUNCTION MENU list

FUNCTION MENU

- Playback Contents
 - Video (⇒ 33)
 - Photo (⇒ 48)
 - Music (⇒ 52)
- TV Guide (⇒ 24)
- Timer Recording (⇒ 29)
- Network
 - Home Network (DLNA Client) (⇒ 59)
 - Home Network (Media Renderer) (⇒ 60)
 - Network Service (⇒ 65)
- Others
 - Playlists (⇒ 36)
 - Copy Video (AVCHD) (⇒ 56)
 - Copy Video (MPEG2) (⇒ 57)
 - Copy New Photos (⇒ 51)
 - SD Card Management (⇒ 61)
 - BD-Video Data Management (⇒ 37)
 - Setup (⇒ 68)
 - You can change the unit's settings of Digital TV Tuning, Sound, Display, Connection, Network etc. in the Setup menu.
- Drive Select
 - HDD
 - Blu-ray Disc / DVD
 - SD Card
 - USB Device
 - USB HDD
 - DIRECT NAVIGATOR screen appears and the "USB HDD" tab is selected.



- Selectable items will change depending on the type and status of the media.

Watching broadcasts

Instructions for operations are generally described using the remote control. (⇒ 11)

Press [CH ^ v] to select the channel.

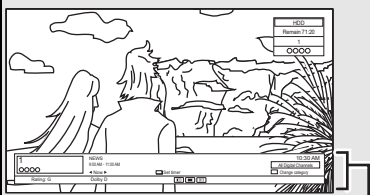

Channel information (⇒ 24)

- You can also select the channel by the following operations
 - Using number buttons.
 - Using Channel List (⇒ right)
 - Using TV Guide system (⇒ 24)
 - Using channel information (⇒ 24)

To switch to the channel you have previously watched

Press [LAST VIEW ○].

- This function does not work correctly depending on the situations.

To switch to the radio channels

Press [RADIO/TV].

Watching 3D video

Refer to "3D video playback". (⇒ 40)



- If you have set a ratings level, you may be asked to enter the PIN to start viewing the broadcast. (⇒ 71, Child Lock (Parental Rating))

Using Channel List

You can select from the list of channel names.

1 Press [OK].

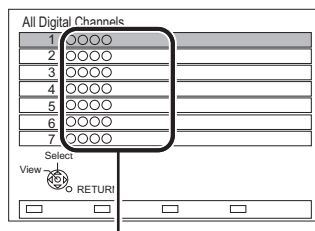

Channel names

2 Select the channel, then press [OK].

To edit the Channel List

Refer to "Channel List". (⇒ 71)

Watching broadcasts

Using TV Guide system

- 1 Press [GUIDE].
TV Guide screen appears.



- 2 Select the programme, then press [OK].
- 3 Select "View", then press [OK].

Page up/down

Press [CH ^ v].

To view a programme list for another day

Press the green button (Previous) or the yellow button (Next).

To see programme information

Press [STATUS ⓘ].

To retrieve the programme data for the area where data have not been acquired

Select the area, then press [STATUS ⓘ].

To set a timer Recording using the TV Guide System

Refer to "Timer recording". (⇒ 29)



- Selection of channel is made easy by creating a Favourite of the channels you watch often. (⇒ 70, Favourites Edit)

Using channel information

While watching a programme

Press [STATUS ⓘ].

e.g.,

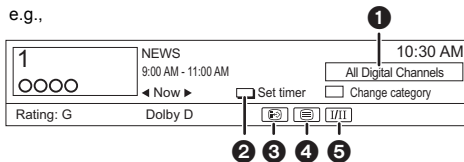

- 1 Current Category
- 2 Set timer (⇒ 31)
- 3 Subtitle
- 4 Teletext
- 5 Multiple audio

To show detailed information

Press [STATUS ⓘ] again.

To hide the information screen

Press [EXIT ⊗].

To change Category

Press the blue button.

• Register your favourite channels

- 1 Press [OPTION].
- 2 Select "Digital TV Menu", then press [OK].
- 3 Select "Favourites Edit", then press [OK].
- 4 Refer to "Favourites Edit". (⇒ 70)

To switch between the current programme and the next programme

Press [◀, ▶].

To switch to another channel

Press [▲, ▼], then press [OK].

Operations while watching broadcast

To show subtitle

When "Ⓜ" appears in channel information (⇒ 24)

Press [STTL Ⓜ].

- Press again to hide subtitle.

Switching audio

Press [AUDIO].

- Audio will switch according to the contents of the programme every time it is pressed.

To show Teletext

When "☰" appears in channel information (⇒ 24)

- 1 Press [TEXT ☰].
- 2 Use [▲, ▼, ◀, ▶], number buttons or colour buttons, etc. according to on-screen instructions.



- You can change the display mode. (⇒ 68, 76, Teletext)

Aspect

You can switch the screen mode.

Refer to "Switching the aspect ratio of the screen". (⇒ 83)

REWIND LIVE TV/PAUSE LIVE TV

This unit temporarily saves a live TV programme you are watching with this unit's tuner on HDD.

REWIND LIVE TV

You can rewind live TV programme up to 1.5 hours before.

PAUSE LIVE TV

You can pause live TV programme and restart watching from the paused position.

- 1 While watching TV

REWIND LIVE TV:

Press [SLOW/SEARCH ◀◀] to rewind.

PAUSE LIVE TV:

Press [PAUSE ■■] to pause.

- 2 When you want to resume:

Press [PLAY/× 1.3 ▶].

- You can perform search or Quick View, etc.
- If temporary save stops (⇒ 26), playback will be performed by that point.

Watching broadcasts

Display information

While pausing or rewinding a broadcast:
Press [STATUS ].

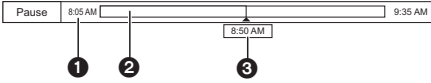

- Press [STATUS ] again.

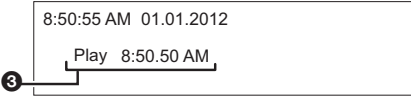

- ❶ The time that you can rewind the live programme.
- ❷ The amount of time temporarily saved on HDD.
- ❸ The time of the current playback position.

To stop REWIND LIVE TV or PAUSE LIVE TV

- 1 Press [STOP ].
- 2 Select "Yes", then press [OK].

To hide the display information

Press [EXIT ].



- From the moment the amount of temporary save exceeds 1.5 hours, the time display counts up to show the limit of rewinding.
- Temporary save stops in the following cases:
 - When switching to other channels or other screen
 - When recording of the watching programme is started
 - When two programmes simultaneous recording is started
 - When performing PAUSE LIVE TV or REWIND LIVE TV for more than 8 hours (This may vary depending on the HDD free space.)
- These functions do not work in the following cases:
 - When the clock is not set
 - While recording two programmes simultaneously
 - While copying
 - While watching a programme being recorded
 - When a radio programme is selected
 - REWIND LIVE TV:
 - When "REWIND LIVE TV" is set to "Off" (⇒ 73)
- PAUSE LIVE TV:

You can operate this unit with the TV remote control by using VIERA Link (⇒ 64). Refer to the TV operating instructions.

Recording TV programmes

The titles can only be recorded to built-in HDD and cannot be copied from built-in HDD to the media other than USB HDD.



- This operation will only record to built-in HDD.
- This unit can record two programmes being broadcasted at the same time.

1 Select the channel to record.

2 Press [REC ●].

Recording starts.

- "REC1" or "REC2" will light on the unit's display.

3 Select "Automatic Stop", then press [OK].

• One touch recording (OTR)

Recording stops automatically when the programme ends.

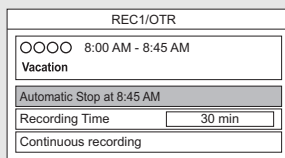

- You can also select "Recording Time" or "Continuous recording". (⇒ right)

To set the recording time

- 1 Select "Recording Time" or "Continuous recording" in step 3 (⇒ left).

Recording Time:

You can set the length of recording time from 30 minutes to 4 hours.

- You can select the recording time with [◀, ▶].

Continuous recording:

The recording is continued until you press [STOP ■].

- 2 Press [OK].



- One recording will terminate when simultaneous recording is being done and timer recording starts.
- Teletext will not be recorded.
- Following operations cannot be performed while recording.
 - playback of 3D BD-Video in 3D
 - playback of DivX and MKV file
 - playback of photo
 - playback of USB memory
 - copying of photo to the HDD
 - copying of AVCHD video to the HDD
- When "Automatic Standby after OTR" is set to "On" (⇒ 79), this unit is turned to standby mode if this unit is not operated for approximately 5 minutes after completing "Automatic Stop" or "Recording Time".

Recording TV programmes

Operation during Recording

To check the recording programme

Press [STATUS ].

e.g., While recording two programmes simultaneously

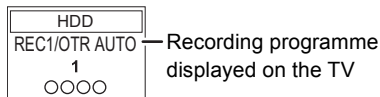

Recording programme not displayed on the TV

To stop recording

Press [STOP ].

When recording one programme:

If the following screen appears

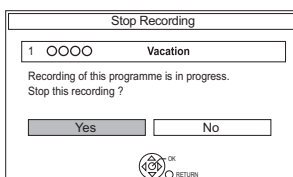

Select "Yes", then press [OK].

When recording two programmes:

If the following screen appears

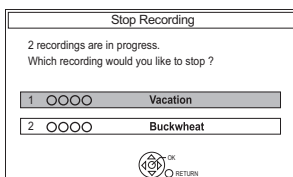

- 1 Select the programme, then press [OK].
- 2 Select "Yes", then press [OK].

To pause recording

After displaying the recording programme, press [PAUSE ].

- Press again to restart recording.
(A title is not split into separate titles.)



- Timer recording programme cannot be paused.

To record two programmes simultaneously

While recording, perform steps 1–3 on page 27.



- Channel can only be switched between the recording programmes.

Simultaneous rec and play

You can play the recording title from the beginning or the titles previously recorded to the HDD.

- 1 Press [DIRECT NAVIGATOR].

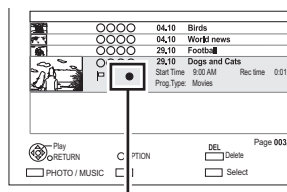

"●" is displayed on the recording programme.

- 2 Select the title, then press [OK].

Timer recording



- This operation will only record to built-in HDD.
- This unit can record two programmes being broadcasted at the same time.

1 Press [GUIDE].

TV Guide screen appears.



2 Select the programme, then press the red button.

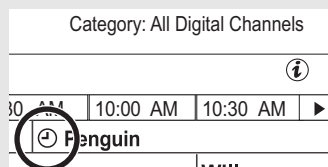

The timer icon (red) is displayed.

To use TV Guide system

Refer to "Using TV Guide system". (⇒ 24)

To edit the timer recording on the TV Guide screen

- 1 Select the programme to edit, then press the red button.
- 2 Select "Timer Rec Edit", then press [OK].
- 3 Go to step 3 on page 30.

To cancel a timer recording on the TV Guide screen

- 1 Select the programme to cancel, then press the red button.
- 2 Select "Timer Rec Cancel", then press [OK]. ("⊖" disappears)

Operation during Recording

Refer to "Operation during Recording". (⇒ 28)



- Some broadcast may not send programme information. When programme information is not displayed correctly, use manual timer recording. (⇒ 30)
- You can set the start and finish time to make the timer recording work successfully. (⇒ 68, 73, Timer Record Start Buffer, Timer Record Stop Buffer)

To select the programmes of a specific category

- 1 On the TV Guide screen:
Press the blue button.
- 2 Select the item, then press [OK].

To return to the previous TV Guide list

Select "All Digital Channels" in step 2.



- Category may not be assigned correctly depending on the programme information.

Timer recording

Manually programming timer recording

- 1 Press [PROG/CHECK].

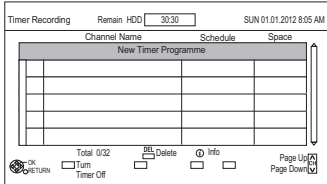

- 2 Select "New Timer Programme", then press [OK].

- 3 Select the items and change the items. (⇒ right, Timer recording options)

- 4 Press [OK].
The timer programme is stored.

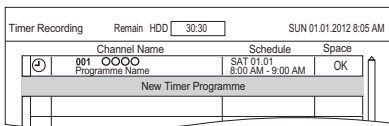
**To confirm and edit the timer programme**

Refer to "To confirm and edit a timer programme". (⇒ 32)

Operation during Recording

Refer to "Operation during Recording". (⇒ 28)

Timer recording options

Select the items and change the items.

e.g.,

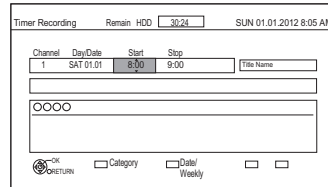
**Channel**

- You can select Category with the red button.

Day/Date

- You can select "Date" or "Weekly" by pressing the green button.

Start/Stop

- Press and hold [▲, ▼] to alter in 15-minute increments.

Auto Renewal Recording

(Only daily/weekly timer recording)

The unit will record the new programme over the old one.

- 1 Select "Renew".
- 2 Select "ON".

Title Name

- 1 Select "Title Name", then press [OK].
- 2 Refer to "Entering text". (⇒ 83)



Timer recording from channel information

You can make timer recording of the current or next programme.

- 1 While watching a programme
Press [STATUS ].

e.g.,



- 2 Display the channel information of a programme to record.
 - Switch the programme with [, ].
- 3 Press the yellow button.
- 4 Go to step 3 on page 30.

Notes on timer recording

- You can enter up to 32 programmes within a month in advance. (Each daily or weekly programme is counted as one programme.)
- Even if you switch the unit to standby mode during the timer recording, the recording is continued.
- When you programme successive timer recordings to start, about last 1 minute of earlier programme will not be recorded.

Conditions when timer recording will not start

(-: Will not start, ○: Will start)

Executing operation	Starting of the timer recording
Recording the title ^{*1}	○
Playing the title ^{*2}	○
Editing the title	○
Copying HD Video (AVCHD format) from USB device or SD card	-
Executing PAUSE LIVE TV/REWIND LIVE TV ^{*1}	○
Editing photo	-
Copying photos	-
Editing music	○
Copying music	-
Formatting	-

^{*1} The operation will terminate when simultaneous recording is being done and timer recording starts.

^{*2} 3D playback of BD-Video will terminate when the timer recording starts.

Timer recording

To confirm and edit a timer programme

1 Press [PROG/CHECK].

e.g.,

Timer Recording Remain HDD 30:30 SUN 01.01.2012 8:05 AM

Channel Name	Schedule	Space
World news	SAT 08:01 11:30 AM - 11:45 AM	OK
Football	SAT 08:01 10:30 AM - 11:50 AM	OK
Star	SAT 08:01 11:30 AM - 1:00 AM	1
Dogs and Cats	SAT 01:01 8:00 AM - 10:45 AM	

New Timer Programme

Total 3/32 Delete Info Page Up Page Down

OK RETURN Turn Timer Off Delete Info Page Up Page Down

2 Select the programme, then perform the operations.

To deactivate a timer programme

Press the red button.

- The timer icon “⊖” will change from red to grey.
- Press the red button again to activate timer recording standby. (The timer icon “⊖” will change to red.)

To delete a timer programme

Press [DEL].

To edit a timer programme

- 1 Press [OK].
- 2 Change the timer recording options.
 - Refer to “Timer recording options”. (⇒ 30)
- 3 Press [OK].

To show programme information

Press [STATUS ⊕].

To exit the timer recording list

Press [EXIT ⊗].

Screen icons

- ⊖ Red: Timer recording standby is activated.
Grey: Timer recording standby is deactivated.

- Currently recording programme

- ⊖ A part or all of the programme will not be recorded since the programme is overlapping.

- ⊖ The HDD is full.

- ⊖ Copy-protected programme
It was not recorded.

- ⊖ The recording of the programme was not completed because of some reason.

- ⊖ Auto Renewal Recording is set (⇒ 30).

- OK Displayed if the recording can fit in the remaining space

- > Daily or weekly timer programme is set.

- (Date)

- ! It may not be possible to record because:
 - there is not enough space left.
 - the number of possible titles has reached its maximum. (⇒ 95)
 - programmes are deactivated, etc.

Playing titles on the HDD



- 1 Press [DRIVE SELECT] to select "HDD", then press [DIRECT NAVIGATOR].
e.g.,

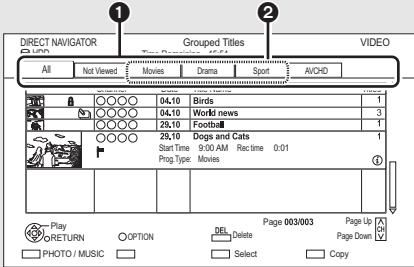

- 1 Tab (⇒ 34)

- 2 Programme type

- **USB HDD** When connecting registered USB HDD, "USB HDD" tab and registration number appears. Select "USB HDD" tab.
e.g.,

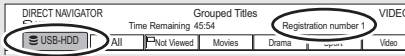

- 2 Select the title, then press [OK].
Playback starts.

Resume play function

If the following screen appears, select the point to start playback.



DIRECT NAVIGATOR (VIDEO) screen

Screen icons

- Currently recording programme
- Protected title
- Title was not recorded due to recording protection
- Title cannot be played
(When data is damaged etc.)
- Grouped titles
- Title has not yet been played
- Title is recorded using a different encoding system from that of the unit.
 Change the "TV System" (⇒ 68, 76).
- Radio programme
- 3D contents
 - This icon will not display even with 3D programmes when a broadcast programme is recorded.
- Recorded in 1080/50p contents
- Recorded in 1080/60p contents
- Title is restricted by Child Lock (Parental Rating) (⇒ 71).
- Recording did not complete as the timer recording has started.

Playing titles on the HDD

Tab

Titles will be categorised automatically. You can quickly find the recorded titles by selecting the tab.

To select the tab

Press [◀, ▶].

To change the displayed programme type tab

- 1 Select the programme type, then press the green button.
- 2 Select the item, then press [OK].

To change the programme type of title

Refer to "Changing programme type of title".
(⇒ 44)

Switching to the PHOTO or MUSIC screen

- 1 Press the red button.
- 2 Select "PHOTO" or "MUSIC", then press [OK].

Showing Information

Select the title, then press [STATUS ⓘ].

Switching the appearance

- 1 Press [OPTION].
- 2 Select "Grouped Titles" or "All Titles", then press [OK].

Grouped Titles:

Two or more titles recorded in the daily/weekly timer recording mode are bundled and displayed as one item.

All Titles:

Displays all titles.

Playing back grouped titles

- 1 On the Grouped Titles screen:
Select the item marked with .
- 2 **All titles:**
Press [PLAY/×1.3 ▶].

Individual title:

Press [OK] and select the title, then press [OK].

Editing the grouped titles

- 1 Select the title or the group, then press the yellow button.
 - A check mark is displayed. Repeat this step.
 - Press the yellow button again to cancel.
 - If you perform "Remove", select the title in the group.
- 2 Press [OPTION].
- 3 Select the item, then press [OK].

Create Group:

Selected titles are bundled to form a group. Select "Create", then press [OK].

Release Grouping:

All the titles in the group are released. Select "Release", then press [OK].

Remove:

Selected titles are removed from the group. Select "Remove", then press [OK].

Changing the group name

- 1 Select the group, then press [OPTION].
- 2 Select "Edit", then press [OK].
- 3 Select "Enter Title Name", then press [OK].
- 4 Refer to "Entering text". (⇒ 83)

Playback from Chapter View

Regarding chapters

You can divide a title into multiple chapters. Each section between the division points (Chapter Marks) becomes a chapter.

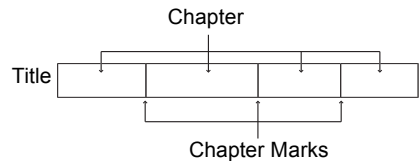

- 1 Select the title, then press [OPTION].
- 2 Select "Chapter View", then press [OK].
e.g., **HDD**

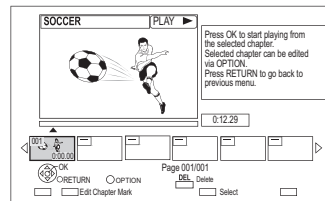

- 3 Select the chapter, then press [OK].

To edit the chapter in Chapter View

Refer to "Editing chapters". (⇒ 45)

Playing titles on the media



1 Insert the media.

Depending on the type of the media, play starts from the specified position, or the screen appears.

- AVCHD: If the menu screen is not displayed
Press [PLAY/×1.3 ▶].

2 When the DIRECT NAVIGATOR screen or menu screen etc., appears:

Select the item or title, then press [OK].

- Repeat this step if necessary.

Playback starts.

To play back the playlist created on other equipment

- 1 Press [FUNCTION MENU].
- 2 Select "Playlists" in "Others", then press [OK].
- 3 Select the playlist, then press [OK].



- Some DivX and MKV files may not be played back, depending on the video resolution and frame rate condition.

Menu screen

Selecting screen for each operation is displayed when the media is inserted, and you can access the operation screen easily.

e.g., **[USB]**

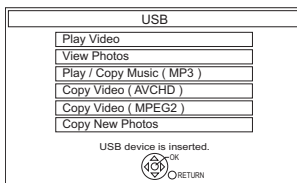

- Display items differ depending on what is recorded in each media.

If the menu screen is not displayed, display it by performing the following operation.

- 1 While stopped
Press [OPTION].
- 2 Select "Drive Select", then press [OK].
- 3 Select the media, then press [OK].

Video list screen

e.g.,

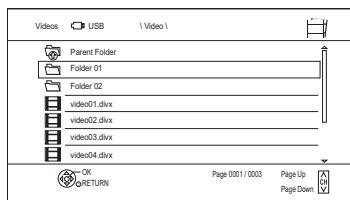

Screen icons:



Folder



Titles



Move to the parent folder

DIRECT NAVIGATOR screen

e.g.,

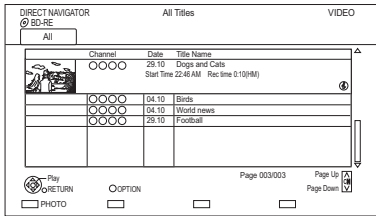

Switching to the PHOTO screen

Press the red button.

The screen switches from "VIDEO" to "PHOTO".

Showing Information

Select the title, then press [STATUS].

Playback from Chapter View

- 1 Select the title, then press [OPTION].
- 2 Select "Chapter View", then press [OK].
- 3 Select the chapter, then press [OK].

• Regarding chapters

Refer to "Regarding chapters". (⇒ 35)

DIRECT NAVIGATOR (AVCHD) screen

SD

e.g.,

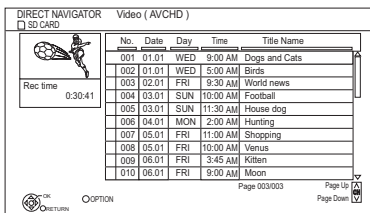

Showing Information

- 1 Select the title, then press [OPTION].
- 2 Select "Information", then press [OK].

Notes for BD-Live discs

BD-V

BD-Live allows you to enjoy more functions such as subtitles, exclusive images and online games by connecting this unit to the Internet.

Preparation

- 1 Perform network connection and settings. (⇒ 17, 20)
- 2 Insert a disc.

For the playback method, refer to the instructions for the disc.

Delete BD-Video data

If you no longer need BD-Live data recorded on the built-in HDD, you can delete data with the following operation.

- 1 Press [FUNCTION MENU].
- 2 Select "BD-Video Data Management" in "Others", then press [OK].
- 3 Select "Delete BD-Video data", then press [OK].
- 4 Select "Yes", then press [OK].
- 5 Select "Start", then press [OK].
- 6 Press [OK].



- The usable functions and the operating method may vary with each disc, please refer to the instructions on the disc.
- You can restrict Internet access when BD-Live functions are used (⇒ 68, 73, BD-Live).

Operation during play



- Depending on the media and the type of file, some operations may not be possible.
- Depending on the media, it may take time for the menu screen, pictures, sound, etc. to start.
- Discs continue to rotate while menus are displayed. Press [STOP ■] when you have finished playback to protect the unit's motor, your TV screen, etc.

General operations

Status messages

Press [STATUS ⓘ] twice.

e.g.,

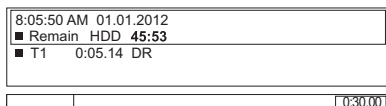

Stop

Press [STOP ■].

Resume play function

Press [PLAY/× 1.3 ▶] to restart from the stopped position.

- The resume play function does not work depending on the disc.
- Stopped position

HDD **USB HDD**:

Stopped position for each title is memorized.

Discs:

Only previous stopped position is memorized. The position is cleared if the tray is opened or the unit is switched to standby mode.

Quick View

HDD **USB HDD** **SD**

Press and hold [PLAY/× 1.3 ▶].

- Press again to return to normal speed.

Search

Press [SLOW/SEARCH ◀◀] or [SLOW/SEARCH ▶▶].

- Press [PLAY/× 1.3 ▶] to restart play.



- The speed increases up to 5 steps.
(+R +RW): Up to 3 steps
- **DivX**, **MKV**, **MP4** and **MPEG2** (**USB**): Audio is not heard during all levels search.

Pause

Press [PAUSE ||].

- Press [PLAY/× 1.3 ▶] to restart play.

Slow-motion

While paused, press [SLOW/SEARCH ◀◀] or [SLOW/SEARCH ▶▶].

- Press [PLAY/× 1.3 ▶] to restart play.



- The speed increases up to 5 steps.
- **DivX**, **MKV**, **MP4** and **MPEG2** (**USB**): This function is not effective.
- **BD-V**, **AVCHD** (**SD**): Forward direction [SLOW/SEARCH ▶▶] only.

Frame-by-frame

While paused, press [**◀**] (**◀◀**) or [**▶**] (**▶▶**).

- Each press shows the next frame.
- Press and hold to change in succession forward or backward.
- Press [PLAY/×1.3 ▶] to restart play.



- **DivX, MKV, MP4 and MPEG2 (USB)**: This function is not effective.
- **BD-V, AVCHD (SD)**: Forward direction [**▶**] (**▶▶**) only.

Manual Skip

Skip forward 1 minute:

Press [MANUAL SKIP +60s].

Skip backward 10 seconds:

Press [MANUAL SKIP -10s].



- **DivX and MKV**: This function is not effective.

Skipping the specified time

- 1 Press [TIME SLIP].
- 2 Select the time with [**▲**, **▼**].
 - Press and hold [**▲**, **▼**] to change the time by 10-minute.
- 3 Press [OK].
 - Play skips the specified time.



- **BD-V DVD-V, DivX, MKV, AVCHD, MP4 and MPEG2 (USB)**: This function is not effective.

To display Pop-up Menu

BD-V

Press [DIRECT NAVIGATOR].

- Press again to exit.

To display Top Menu

BD-V DVD-V

- 1 Press [OPTION].
 - 2 Select “Playback Menu”, then press [OK].
 - 3 Select “Top Menu”, then press [OK].
- If the Top Menu is not displayed
Press [DIRECT NAVIGATOR].

Skipping the title or chapter

Press [SKIP ◀◀] or [SKIP ▶▶].



- **HDD USB HDD**: It will not skip the title. But the title in the grouped titles during the “All Titles” will be skipped. (⇒ 34)

To create Chapter Marks

HDD USB HDD

During the playback or pause
Press [CHAPTER].

To delete the Chapter Mark

HDD USB HDD

- 1 While paused
Press [SKIP ◀◀] or [SKIP ▶▶] and skip to the location you want to delete.
- 2 Press [CHAPTER].
- 3 Select “Yes”, then press [OK].

Operation during play

Changing audio

Press [AUDIO].

- It will switch depending on the contents recorded every time it is pressed.

Switching subtitles

[HDD] [USB HDD] [BD-RE] [BD-R]:

Press [STTL ].

- If you want to switch the subtitle language, select it in the Disc menu (⇒ 66).

[BD-V] [DVD-V], DivX and MKV:

Display with "Subtitles" in the Disc menu (⇒ 66).

Aspect

You can switch the screen mode.

Refer to "Switching the aspect ratio of the screen". (⇒ 83)

3D video playback

Preparation

Connect 3D compatible TV to this unit. (⇒ 13)

- Perform the necessary preparations for the TV.

Play back following the instructions displayed on the screen.

Preparatory 3D settings

Perform the following settings as necessary.

3D BD-Video Playback

It is also possible to play back 3D discs in 2D (conventional video). (⇒ 68, 72)

3D Type

If 3D video cannot be played back in 3D, you may be able to play it in 3D by changing the setting. (⇒ 68, 76)

3D AVCHD Output

If 2D AVCHD video is recognised as 3D video and cannot be played back correctly, you may be able to play it by changing the setting. (⇒ 68, 76)

3D Playback Message

Hide the 3D viewing warning screen. (⇒ 68, 76)

Graphic Display Level

Adjust the 3D position for the playback menu or message screen etc. (⇒ 66)

3D settings during playback

Change this setting when the screen is not correctly displayed for 3D compatible programmes.

- 1 Press [OPTION].
- 2 Select "3D Settings", then press [OK].
- 3 Select the item, then press [OK].

Signal Format

- **Original**
Keep original picture format.
- **Side by side**
3D picture format comprising of left and right screens.
- **2D to 3D***
Converts 2D pictures to 3D effect while playing.

3D Picture Mode*

- **Normal**
Normal 3D effects.
- **Soft**
Soft 3D effects.
 - This function cannot be enabled when "Signal Format" is set to "2D to 3D".
- **Manual Settings**
Set 3D effect manually.
 - **Distance**
Set the amount of depth perception.
 - **Screen Type**
Selects how the screen appears during 3D playback (flat or round).
 - **Frame Width**
Set the amount of feathering at the edge of screen.
 - **Frame Colour**
Set the colour of feathering at the edge of screen.

* This function is not effective while watching broadcast.



- Depending on the contents, displayed items are different.
- Subtitles and TV Guide, etc., may not display correctly depending on the settings.
- 3D BD-Video can be played back in 3D only when this unit is connected to the Full HD 3D compatible TV.
- This unit only guarantees the playback of the Frame Sequential and the Side-by-Side (Half) programme types.
- Please refrain from viewing 3D images if you do not feel well or are experiencing visual fatigue.
In the event that you experience dizziness, nausea, or other discomfort while viewing 3D images, discontinue use and rest your eyes.
- Depending on the connected TV, the video being played back might switch to 2D video due to changes in resolution etc. Check the 3D setting on the TV.
- 3D video might not output the way it is set in "HDMI Video Format" (⇒ 77) and "24p Output" (⇒ 77).
- It may display as Side-by-Side when playback of the 3D video is started.
- 3D BD-Video cannot be played back in 3D while recording. Also, 3D playback stops when the timer recording starts.

Deleting recorded titles

Once deleted, recorded content cannot be restored to its original state. Make certain before proceeding.

Deleting during play

- 1 Press [DEL] while playing.
- 2 Select "Delete", then press [OK].



- 1 On the DIRECT NAVIGATOR screen:
Select the title.

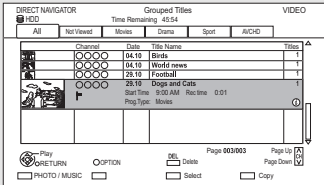

- 2 Press [DEL].
- 3 Select "Delete", then press [OK].

Multiple deleting

Select the title, then press the yellow button in step 1.

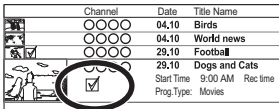

A check mark is displayed. Repeat this step.

- Press the yellow button again to cancel.

Editing recorded titles

Partial deleting

- 1 Select "Partial Delete" in "Edit", then press [OK].
- 2 Press [OK] at the start point and end point to delete.
 - You can find the desired point by using play, search, etc. (⇒ 38)
- 3 Select "Continue", then press [OK].
 - Select "Next", then press [OK] to delete other sections. Up to 20 sections can be set. (⇒ go to step 2)
- 4 Select "Delete", then press [OK].
 - Chapter Mark is generated in the scene that was partially deleted.
- 5 Press [RETURN ⊖].

Dividing title

- 1 Select "Divide Title" in "Edit", then press [OK].
- 2 Press [OK] at the point to divide the title.
 - You can find the desired point by using play, search, etc. (⇒ 38)
- 3 Select "Continue", then press [OK].
- 4 Select "Divide", then press [OK].

To confirm the division point

After performing step 2.

Select "Preview", then press [OK].

- The unit plays 10 seconds before and after the division point.

To change the division point

After performing step 2.

Restart play and select "Divide", then press [OK] at the division point.



- Divided titles will become a group of titles.

Changing thumbnail

- 1 Select "Change Thumbnail" in "Edit", then press [OK].
- 2 Press [OK] at the point to use as a thumbnail.
 - You can find the desired point by using play, search, etc. (⇒ 38)
- 3 Select "Finish", then press [OK].

To change the point

After performing step 2.

Restart play and select "Change", then press [OK] at the point to change.



- It is possible to change the image displayed on the Top Menu after finalising or creating Top Menu.

Changing programme type of title

HDD

Programme type information in the title can be edited.

- 1 Select "Change Prog.Type" in "Edit", then press [OK].
- 2 Select the item to change a programme type, then press [OK].
- 3 Select the programme type, then press [OK].
- 4 Select "Set", then press [OK].

Editing chapters

- 1 Select "Chapter View", then press [OK].
- 2 Perform the editing operations.

Edit Chapter Mark:

Select the point where you want to start a new chapter while viewing the title.

- 1 Press the green button.
- 2 Press [OK] at the point you want to divide.
 - Repeat this step.
- 3 Press [RETURN Ⓢ] to go to Chapter View screen.

To delete the chapter:

- 1 Select the chapter, then press [DEL].

Multiple editing

Select the chapter, then press the yellow button.

A check mark is displayed. Repeat this step.

- Press the yellow button again to cancel.

- 2 Select "Delete", then press [OK].

To combine chapters (Delete chapter mark):

- 1 Select the chapter, then press [OPTION].
- 2 Select "Combine Chapters", then press [OK].
- 3 Select "Combine", then press [OK].
The selected chapter is combined to the next chapter.

Playback from Chapter View

Refer to "Playback from Chapter View". (⇒ 35)



- The maximum number of chapters:
(Depends on the state of recording.)
Approx. 1000 per title
- When the title has the maximum number of chapters, you cannot perform the Resume play function (⇒ 33) or the "Change Thumbnail" (⇒ 44) with the title.

Copying titles



* The title in the source media will be deleted.

- 1** Connect the **USB HDD**.
 - 2** Press **[DRIVE SELECT]** to select **"HDD"**, then press **[DIRECT NAVIGATOR]**.
 - 3** Select the title, then press the yellow button.
A check mark is displayed. Repeat this step.
- | | Channel | Date | Title Name |
|--|---------|------------|------------------|
| | ○○○○ | 04.10 | Birds |
| | ○○○○ | 04.10 | World news |
| | ○○○○ | 29.10 | Football |
| | ○○○○ | 29.10 | Dogs and Cats |
| | | Start Time | 9:00 AM Rec time |
| | | Prog.Type | Movies |
- Press the yellow button again to cancel.
- 4** Press the blue button.
 - 5** Select **"Yes"**, then press **[OK]**.
 - If you select **"No"**, you can change the selection. (⇒ 47)

- 6** Set other settings, then press **[OK]**.
e.g.,

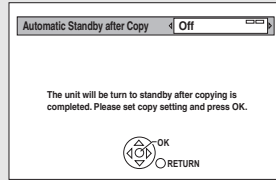

(⇒ 47, Setting the copying options)

- 7** Select **"Yes"**, then press **[OK]**.

To register the external HDD (USB HDD)

Refer to "Registering the external HDD (USB HDD)". (⇒ 62)



- Following operations cannot be performed while copying.
 - playback of 3D BD-Video in 3D
 - playback of DivX and MKV file
 - playback of photo
 - playback of USB memory

To change the selection

- 1 Select "No", then press [OK] in step 5 (⇒ 46).
- 2 Select the title, then press the yellow button.
Repeat this step to select titles.
- 3 Go to step 4 (⇒ 46).

About screen icons on the DIRECT NAVIGATOR

Refer to "Screen icons". (⇒ 33)

Setting the copying options

- 1 Select the item in step 6 (⇒ 46).
- 2 Press [◀, ▶] to change the settings.
 - **Automatic Standby after Copy On:**
This unit is turned to standby mode when it is not operated for approximately 5 minutes after completing copy.

Playing photos

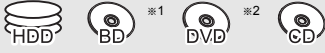

※1 **BD-RE** only

※2 **DVD-R** only

• In order to play back 3D photo (MPO), this unit should be connected to a Full HD 3D compatible TV.

1 **HDD**

- 1 Press **[FUNCTION MENU]**.
- 2 Select **"Photo"** in **"Playback Contents"**, then press **[OK]**.



- 1 Insert the media.
The menu screen appears. (⇒ 36)
- 2 Select **"View Photos"**, then press **[OK]**.

2 Select the event, then press **[OK]**.

e.g., **HDD**

Tab

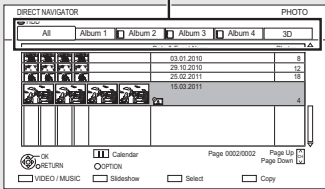

- **To select the tab**
Press **[◀, ▶]**.
- **Start Slideshow**
Refer to "Slideshow Settings". (⇒ 49)
- **Switching the Calendar screen (HDD)**
Press **[PAUSE ■■]**.

3 Select the photo, then press **[OK]**.

- Press **[◀, ▶]** to display the previous or next photo.

To stop the Slideshow

Press **[RETURN ⊖]**.

To exit the Calendar screen

Press **[PAUSE ■■]**.



- When there are many files and/or folders, some files may not be displayed or be playable. (⇒ 95)

DIRECT NAVIGATOR (PHOTO) screen

e.g., **HDD**

Album (⇒ below)

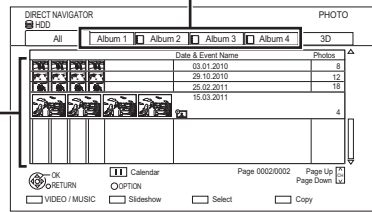

Event

It is displayed for each recording date.

- It is displayed for each folder for media other than HDD.

Screen icons



(Tab)

Album

Placing photos in albums of your choice makes it easier to find them. (⇒ 50)

3D
(Tab)

3D photos (MPO) are automatically sorted. Select from this tab to play back in 3D. (It will play back in 2D when selected from other tabs)



Photo protected



New photo which is stored and not viewed

Switching to the VIDEO or MUSIC screens

HDD:

- 1 On the DIRECT NAVIGATOR screen:
Press the red button.
- 2 Select "VIDEO" or "MUSIC", then press [OK].

BD-RE:

On the DIRECT NAVIGATOR screen:
Press the red button.

Photo play option

- 1 While displaying a photo:
Press [OPTION].
- 2 Select the item, then press [OK].

Photo Menu

• Start Slideshow

You can start a slideshow.

• Rotate RIGHT/Rotate LEFT

e.g.,

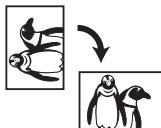

- The information of the rotated photos will not be stored depending on the media.

• Information

Information (shooting date etc.) is shown.

Aspect

You can switch the screen mode. (⇒ 83)

Graphic Display Level

You can change the 3D position of the screen display, etc., during the 3D photo playback.

Slideshow Settings

- 1 On the DIRECT NAVIGATOR screen:
Press the green button.

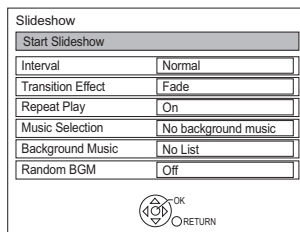

- 2 Select the item, then press [OK].

Start Slideshow

You can start a slideshow.

Interval

You can set up the time until the next photo is to display.

Transition Effect*

Effect for the next photo to display can be set.

Repeat Play

You can set up to play back repeatedly.

Music Selection*

You can select background music on (either from HDD or USB) or off.

Background Music*

You can select background music from HDD (My Favourites or Playlists) or USB (Folder).

Random BGM*

You can play back the BGM (Background Music) in random order.

- * This function is not available during the 3D photo playback.

To pause the Slideshow

Press [PAUSE ■■].

- Press [PAUSE ■■] again to restart.

Editing photos



- 1** On the DIRECT NAVIGATOR screen:

e.g., **HDD**

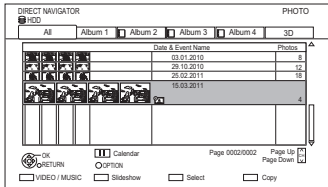

To edit the event:

Select the event.

To edit the photo:

- 1 Select the event, then press [OK].
- 2 Select the photo to edit.
 - Multiple editing
Press the yellow button.
A check mark is displayed. Repeat this step.
 - Press the yellow button again to cancel.

- 2** Press [OPTION].

- Selectable items will change depending on the media and the type of file.

- 3** Select the item, then press [OK].

Edit

• Add to Album

HDD

- 1 Select the destination album, then press [OK].
- 2 Press [OK].

• Combine Events

HDD

Select "Yes", then press [OK].

• Remove from Album

HDD

Select "Yes", then press [OK].

• Enter Album Name

HDD

Refer to "Entering text". (⇒ 83)

• Enter Event Name

Refer to "Entering text". (⇒ 83)

Set up Protection

SD

Select "Yes", then press [OK].

appears when the protection is set.

- Even if the protection is set, the photo may be deleted by another unit.

Cancel Protection

SD

Select "Yes", then press [OK].

Delete Photos

Select "Yes", then press [OK].

Copying photos



Selecting and copying the photos

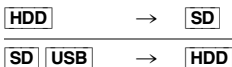

- On the DIRECT NAVIGATOR screen:
To copy the event:
 Select the event, then press the blue button.

To copy the photo:

- Select the event, then press [OK].
- Select the photos to copy, then press the blue button.
 - Multiple editing
 Press the yellow button.
 A check mark is displayed. Repeat this step.
 - Press the yellow button again to cancel.

- When copy to HDD:
 Select "Yes" or "No", then press [OK].
 - If you select "Yes":
 Select the album, then press [OK].
 e.g., **SD**

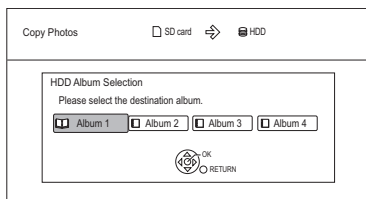

- You can categorise and manage the events and photos on the HDD by copying to the album. (⇒ 48)
- Select "Yes", then press [OK].
 Copying starts.

To stop copying

Press and hold [RETURN ⊕] for 3 seconds.



- The name of the copied photos will be changed.
- If the number of files/folders to be copied exceeds the maximum (⇒ 95), copying will stop partway through.

Copying automatically



Newly added photos will automatically be copied to the HDD.

- Insert the media.
 The menu screen appears. (⇒ 36)
- Select "Copy New Photos", then press [OK].
 e.g., **SD**

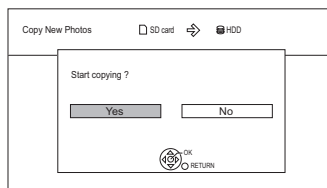

- Select "Yes", then press [OK].
 Copying starts.
- Once the copy is completed, select "Yes" or "No", then press [OK].

To stop copying

Press and hold [RETURN ⊕] for 3 seconds.



- Photos without shooting date will be categorised using the creation date.
- If the space on the destination drive runs out or the number of files/folders to be copied exceeds the maximum (⇒ 95), copying will stop partway through.
- The name of the copied photos will be changed.

Playing music



* **DVD-R** only

Music CD:

Insert the disc.

Playback will automatically start.

MP3:

1 Insert the media.

The menu screen appears. (⇒ 36)

- **DVD-R** **CD** Playback will automatically start if only MP3 is recorded.

2 Select “Play / Copy Music (MP3)” or “Play Music (MP3)”, then press [OK].

Playback will start.

- Using the tree screen to find a folder
 - 1 Press [OPTION].
 - 2 Select “Select Folder”, then press [OK].
 - 3 Select the folder, then press [OK].

To play other music (track)

Select the item, then press [OK].

e.g., **CD** (MP3)

DIRECT NAVIGATOR		Track List	
ⓈCD (MP3)		○○○○	
No.	Track Name		
0001		○○○○	
0002		○○○○	
0003		○○○○	
0004		○○○○	
0005		○○○○	



- The track/artist name will be displayed if the information is contained in ID3 tag of the MP3 file.
- If there is a large amount of photo data etc. within a MP3 file, play may not be possible.

Copying music to HDD

USB → **HDD (MP3)**

- 1 On the DIRECT NAVIGATOR screen of the USB memory:
Press the blue button.
- 2 Select “Copy”, then press [OK].

To stop copying

Press and hold [RETURN ⊕] for 3 seconds.



- While copying, no other operations can be performed. Timer recordings will not proceed.
- All tracks in the folder will be recorded.
- Tracks recorded to HDD in one operation will be regarded as one album.

Playing music recorded on HDD

HDD

- 1 Press [FUNCTION MENU].
- 2 Select "Music" in "Playback Contents", then press [OK].

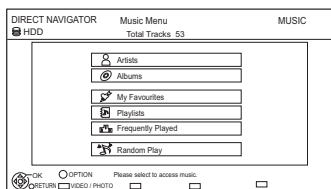

- 3 Select the item, then press [OK].

Artists

- 1 Select the initial of the artist.
- 2 Select the name of the artist, then press [OK].
- 3 Select the album, then press [OK].

Albums

- 1 Select the initial of the album.
- 2 Select the album, then press [OK].

My Favourites

Tracks registered in "My Favourites".

- Registering a track to the "My Favourites". (Up to 99 tracks)

While the Track List screen is displayed:
Select the track, then press the green button.

Playlists

Select the playlist, then press [OK].

Frequently Played

- Tracks most often played recently (up to 30 tracks).

Random Play

Random playback of all tracks.

- 4 Select the track, then press [OK].

Switching to the VIDEO or PHOTO screens

- 1 On the DIRECT NAVIGATOR (Music Menu) screen:
Press the red button.
- 2 Select "VIDEO" or "PHOTO", then press [OK].

Showing Information

On the Track List screen:

- 1 Select the track, then press [OPTION].
- 2 Select "Information", then press [OK].

Playing music

Operations during music play

HDD **DVD-R** **CD** **USB**

Stop

Press [STOP ■].

Pause

Press [PAUSE ■■].

- Press [PLAY/× 1.3 ▶] to restart play.

Search

Press [SLOW/SEARCH ◀◀] or [SLOW/SEARCH ▶▶].

- Press [PLAY/× 1.3 ▶] to restart play.

Skip

During play or while paused, press [SKIP ◀◀] or [SKIP ▶▶].

Repeat Play/Random

Refer to “Repeat Play” or “Random” in Play menu (⇒ 66).

Sound Effects

Refer to “Sound Effects” in Sound menu (⇒ 67).

Displaying photos (Slideshow)

Photos stored on the “Album” of the HDD can be played back as slideshow during playback of the music.

While playing the music

Press the red button.

- To change the photos to display
 - 1 While slideshow playing Press [OPTION].
 - 2 Select “Select Photo Album”, then press [OK].
 - 3 Select the album, then press [OK].
e.g.,

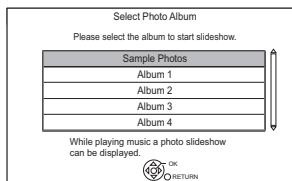

To end the slideshow

Press [RETURN ⊕].

How to create the photo album

Refer to “Add to Album”. (⇒ 50)

To play music continuously even if the Power off link works

Refer to “Playing music continuously even after turning off power to the TV”. (⇒ 64)

Editing music/playlist



- 1 On the DIRECT NAVIGATOR screen:
Press [OPTION].

e.g.,

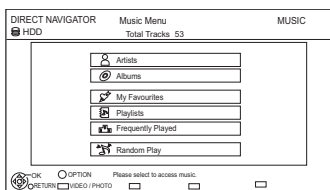

- Selectable items will change depending on the screen.

- 2 Select the item, then press [OK].
e.g., while selecting “Albums”

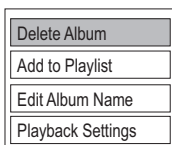

Delete All Tracks

- 1 If the confirmation screen appears:
Select “Yes”, then press [OK].
- 2 Select “Delete”, then press [OK].

Delete Album

Select “Delete”, then press [OK].

Delete

Select “Delete”, then press [OK].

Edit Album Name/Edit Track Name/Edit Artist Name/Edit Playlist Name

Refer to “Entering text” on page 83.

Remove All Tracks

Select “Remove”, then press [OK].

- Tracks themselves are not deleted from the HDD.

Clear My Favourites/Clear Frequently Played

Select “Clear”, then press [OK].

- Tracks themselves are not deleted from the HDD.

Remove

Select “Remove”, then press [OK].

- Tracks themselves are not deleted from the HDD.

Add to Playlist

You can register your favourite albums and tracks into 10 preset playlists.

Select the playlist, then press [OK].

- New playlist cannot be added.
- Up to 999 tracks can be registered to each playlist.

Copying the HD Video or the SD Video



This unit cannot copy the titles in the HDD to the media. Be careful when deleting the original title after copying to the HDD.

e.g., Connecting to the Panasonic video camera

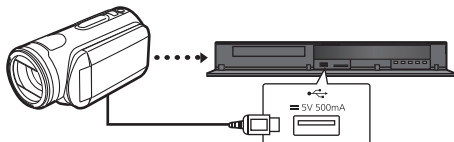

USB connection cable
(optional)



- If you connect a Panasonic product with a USB connection cable, setup screen may be displayed on the connected equipment. For details, refer to the instructions for the connected equipment.

Copying HD Video (AVCHD format)

[SD] [USB], video camera, etc. → [HDD]

- 1 Connect the video camera or insert the media.
 - Make the video camera ready for data transfer.

The menu screen appears. (⇒ 36)
- 2 Select "Copy Video (AVCHD)", then press [OK].

- 3 Select the title, then press the yellow button. A check mark is displayed. Repeat this step.

e.g., [SD]

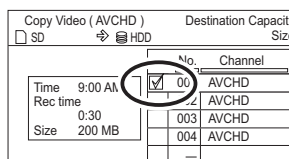

- Press the yellow button again to cancel. (All the recordings on the same date become a title.)

- 4 Press [OK].

- 5 Select "Start", then press [OK].
 - It may take time for the copying to start.

To stop copying

Press and hold [RETURN ☺] for 3 seconds.



- An AVCHD title with 100 or more scenes will be divided into titles every 99th scene and copied.

Screen icons

- [N] (NTSC) Title recorded using a different encoding system from that of the unit.
- [P] (PAL)
 - Titles displaying these marks cannot be selected.

Copying SD Video (MPEG2 format)

SD **USB**, video camera, etc. → **HDD**

- 1 Connect the video camera or insert the media.
 - Make the video camera ready for data transfer.

The menu screen appears. (⇒ 36)

- 2 Select "Copy Video (MPEG2)", then press [OK].
e.g.,

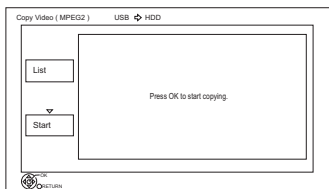

All titles of SD video on the media that can be copied are registered in the copying list.

- 3 Select "Start", then press [OK].
- 4 Select "Yes", then press [OK] to start copying.

To stop copying

Press and hold [RETURN ⊕] for 3 seconds.



- The titles will be copied in the order of the copying list. If you want to specify the order, edit the copying list after the titles are selected.
- The total data size shown may be larger than the sum of the data sizes for each registered item.

To edit the copying list

Select "List", then press [▶] (right) after step 2. (⇒ left)

- 1 Select the title, then press the yellow button. Repeat this step to select titles.
- 2 Press [OPTION].
- 3 Select the item, then press [OK].

Delete All:

All titles that you registered to copy are deleted.

Select "Yes", then press [OK].

Add:

Add new items to the copying list.

- 1 Select the title, then press the yellow button. Repeat this step to select titles.
- 2 Press [OK].

Delete:

Select "Yes", then press [OK].

Move:

Move selected items or change the order of items on the copying list.

Select the destination, then press [OK].

- 4 Press [◀].

Screen icons

Data size of each registered item

No.	Size	Title
	New size	(Total=0)
		Title

Size:

Data size recorded to the HDD

- N** (NTSC) Title recorded using a different encoding system from that of the unit.
 - P** (PAL)
- Titles displaying these marks cannot be selected.

DLNA functions

DLNA function allows you to watch the contents on Server equipment connected on the same network from Client equipment.

This unit can be used both as Server and Client. Additionally, if used as Client, this unit can also be used as Media Renderer, which can be controlled by a Smartphone, etc.

Preparation

- Network connection (⇒ 17, 20)
- Perform Home Network settings of the DLNA compatible equipment.

For more details, refer to the following website and the operating instructions for each item of equipment.

<http://panasonic.jp/support/global/cs/>
(This site is in English only.)



- Some video cannot be played back depending on the equipment, the condition of this unit, or the file type.
- Ensure that the router for your home network has adequate security system to prevent unauthorized access.

Using this unit as Server

You can enjoy the video and photos saved on the HDD of this unit on DLNA (Client) compatible equipment connected via a network.

- The titles with access restriction (e.g., copy restriction) signals sent from broadcasters are not available for this function.
- You cannot play back music from the playback equipment (Client).

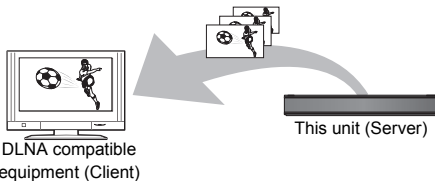

For details regarding the connection and operation of equipment connected via a network, refer to their respective operating instructions.

Preparation

- When DLNA (Server) Function is deactivated, make the settings. (⇒ 68, 79, Home Network Settings)

- 1 Operate the playback equipment (Client) to display the list of contents on this unit.
 - Refer to their respective operating instructions.
- 2 Select the item, then press [OK].



- The DLNA compatible device that is to be connected to the unit should be connected to the same hub or broadband router as the unit.
- Files not on the HDD cannot be played back.
- Playing back 3D video recorded on this unit may not work properly.
- 3D photos copied to this unit cannot be played back in 3D.
- Editing is not possible.
- The name of this unit is not displayed on the server list of DLNA compatible equipment (Client) while playing back a BD-Video.

Using this unit as Client

You can share videos, photos and music stored in the DLNA Certified media server (such as a PC with Windows 7 installed etc.) connected via a network with this unit.

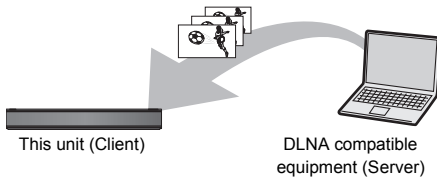

- 1** Press [FUNCTION MENU].
- 2** Select "Home Network (DLNA Client)" in "Network", then press [OK].
A list of equipment connected via the network is displayed.
 - This list can be updated by pressing the red button.
- 3** Select the equipment, then press [OK].
- 4** Select the item, then press [OK].
 - Menu structure will be different depending on the equipment. Select the contents by repeating the operation.
 - Convenient functions can be used by pressing [OPTION] depending on the contents.

Control Panel

Control Panel is displayed once the playback starts.

Operation can be performed with [▲, ▼, ◀, ▶], [OK] and [EXIT ⊗].

- Press [OK] if the Control Panel is not displayed.
- Press [RETURN ⊕] to hide the Control Panel.



- You may not be able to use the Control Panel even if you use the Panasonic DLNA compatible equipment.
- Depending on the contents and the connected equipment, playback may not be possible.
- Playlist of Windows Media® Player can play back only the contents that are stored in the libraries.
- While playing back the 3D programme, you cannot set "3D Settings". (⇒ 41)
- Items displayed in grey on the display cannot be played back by this unit.
- Depending on the performance of the connected PC, video frames may be dropped during playback, or video may not be played back at all. (⇒ 88)

Support format of DLNA client

Video

Container	Video codec	Audio codec	Example of file extension
AVCHD	H.264	Dolby Digital	.mts
MP4	H.264	AAC	.mp4
MOV	H.264	AAC	.mov
Recorded programmes (XP/SP/LP/EP/FR)	MPEG2	Dolby Digital Linear PCM	.mpg .mpeg
Recorded programmes (DR/HG/HX/HE/HL/HM)	MPEG2 H.264	MPEG Dolby Digital	.m2ts .ts

Photo

Format	Example of file extension
JPEG	.jpg

Audio

Audio codec	Example of file extension
MP3	.mp3
FLAC	.flac
Linear PCM	

DLNA functions

Using this unit as Media Renderer

This unit will work as Media Renderer, which allows you to play back the contents on DLNA Server by operating a Digital Media Controller (a smartphone, etc.).

Possible applications:

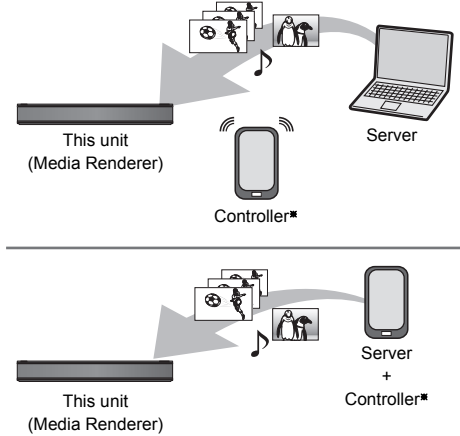

* Digital Media Controller compatible software should be installed.

Following steps are necessary to use this unit as Media Renderer.

- 1 Press [FUNCTION MENU].
- 2 Select "Home Network (Media Renderer)" in "Network", then press [OK].
- 3 Operate the Digital Media Controller compatible equipment.

To exit from Home Network (Media Renderer) screen

Press [RETURN ☺].



- Depending on the contents and the connected equipment, playback may not be possible.
- Items displayed in grey on the display cannot be played back by this unit.
- This unit can be played back via connected equipment only when controlled using Digital Media Controller.
- Depending on the performance of the connected PC, video frames may be dropped during playback, or video may not be played back at all. (⇒ 88)

Format SD card



Formatting deletes all contents (including computer data), and they cannot be restored. Check carefully before proceeding.

- 1** Press [FUNCTION MENU].
- 2** Select "SD Card Management" in "Others", then press [OK].
- 3** Select "Format Card", then press [OK].
- 4** Select "Yes", then press [OK].
- 5** Select "Start", then press [OK].
- 6** Press [OK].



- The contents are deleted when you format a card even if you have set protection.
- **Do not disconnect the AC mains lead while formatting.** This can render the card unusable.
- When a card has been formatted using this unit, it may not be possible to use it on any other equipment.

Registering the external HDD (USB HDD)

If you connect and register a USB HDD, you can move the data in the built-in HDD to the USB HDD, thus saving the capacity in the built-in HDD.

If you use a USB HDD with this unit, the USB HDD must first be registered on this unit.

- Registering of a USB HDD will format the USB HDD and all the content already recorded will be deleted.
- Up to eight USB HDDs can be registered on this unit.
- Registered USB HDDs cannot be used with devices other than this unit.

Regarding the external HDD (USB HDD)

Please use a recommended USB HDD.

For the latest information on recommended USB HDDs, please check the following website.

<http://panasonic.jp/support/global/cs/>

- Certain non-recommended USB HDDs cannot be used with this unit.
- If a problem occurs with the USB HDD, please contact the manufacturer of the device.

Connecting the USB HDD

Connect this unit with optional USB HDD.

e.g.,

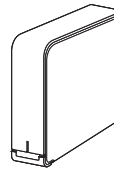
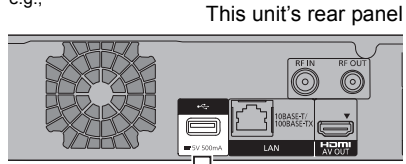

- Only one USB HDD can be connected at the same time.
- Do not connect additional HDDs using a USB hub.
- For details about connection method, refer to the instructions supplied with the USB HDD.

Disconnecting the USB HDD

Please use the following procedure to disconnect. Disconnecting without following this procedure may result in the loss of recorded content from the USB HDD or the internal HDD.

- 1 Press [SETUP].
- 2 Select "Settings for USB HDD" in "HDD / Disc / USB HDD", then press [OK].
- 3 Select "USB HDD Disconnection", then press [OK].
- 4 Select "Yes", then press [OK].
- 5 Disconnect the USB HDD from this unit.

Registering the USB HDD

- If the registering screen appears when connecting the USB HDD, go to step 4.

- 1** Press [SETUP].
- 2** Select "Settings for USB HDD" in "HDD / Disc / USB HDD", then press [OK].
- 3** Select "USB HDD Registration", then press [OK].
- 4** Select "Yes", then press [OK].
 - If you have already registered eight USB HDDs, it will be necessary to delete one or more of them before registering a new USB HDD.
The message screen appears:
 - 1 Select "Yes", then press [OK].
 - 2 Select the USB HDD to cancel, then press [OK].
The confirmation screen appears
 - 3 Select "Yes", then press [OK].
- 5** When the registering is complete, message screen appears.
Press [OK].
- 6** The confirmation screen appears.
Press [OK].

To cancel all USB HDD registrations

Refer to "Cancellation of all USB HDD Registrations". (⇒ 74)



- If you register a USB HDD, all the content already recorded on the USB HDD will be deleted.
- It is not possible to play back the content on the USB HDD whose registration has been cancelled.
- You can check the registration number of the USB HDD on the DIRECT NAVIGATOR. (⇒ 33)

VIERA Link functions

What is VIERA Link "HDAVI Control"?

VIERA Link "HDAVI Control" is a convenient function which will link the operations of this unit and a Panasonic TV (VIERA) or an amplifier/receiver. You can use this function by connecting the equipment with the HDMI cable. See the operating instructions for connected equipment.

Download from TV

When you connect the unit to a TV for the first time, the setting information on the TV is acquired by this unit. (⇒ 19).

- This function is available with the TV that supports "HDAVI Control 3" or later.

• Automatic input switching • Power on link

When the following operations are performed, the input channel of the TV will be automatically switched and the screen of this unit will be displayed. Additionally when the TV is off, the TV will automatically turn on.

- When play starts on this unit
- When an action that uses DIRECT NAVIGATOR or FUNCTION MENU etc, is performed

Power off link

When you set the TV to standby mode, this unit is also automatically set to standby mode.

- Power off link function does not work when recording, copying etc.

Playing music continuously even after turning off power to the TV

The following operations make it possible to keep the power of the unit on and to play music continuously.

When the unit is directly connected to an amplifier/receiver.

- 1 While playing music Press [OPTION].
- 2 Select "TV Power Off", then press [OK].

- Sound may be discontinued for several seconds when the power to the TV is turned off.
- This function is available with the TV that supports "HDAVI Control 2" or later.

PAUSE LIVE TV

You can operate this unit with the TV remote control.

Refer to "PAUSE LIVE TV". (⇒ 25)

- This function is available with the TV that supports "HDAVI Control 3" or later.

Direct TV Recording

This function allows you to immediately start recording the programme that you are viewing on the TV.

Refer to the TV operating instructions for operation.

- This function is available with the TV that supports "HDAVI Control 3" or later.

Easy control only with VIERA remote control

You can operate this unit using the TV remote control.

Refer to the operating instructions of the TV about the buttons that you can use.

- This function is available with the TV that supports "HDAVI Control 2" or later.



- This unit supports "HDAVI Control 5" function. "HDAVI Control 5" is the newest standard (current as of November, 2011) for Panasonic HDAVI Control compatible equipment. This standard is compatible with Panasonic's conventional HDAVI equipment. Please refer to individual manuals for other manufacturers' equipment supporting VIERA Link function.
- VIERA Link "HDAVI Control", based on the control functions provided by HDMI which is an industry standard known as HDMI CEC (Consumer Electronics Control), is a unique function that we have developed and added. As such, its operation with other manufacturers' equipment that supports HDMI CEC cannot be guaranteed.
- These functions may not work normally depending on the equipment condition.
- Use the remote control supplied with this unit if you cannot operate this unit using buttons on the TV remote control.
- The operation of this unit may be interrupted when you press certain buttons on the TV remote control.

VIERA Connect (Enjoying Internet Service)

VIERA Connect allows you to access some specific websites supported by Panasonic, and enjoy Internet contents such as photos, videos, etc. from VIERA Connect home screen. This unit has no full browser function and all features of websites may not be available.

e.g.,

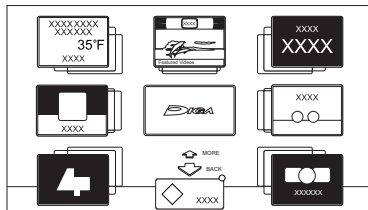

VIERA Connect Home screen

- Images are for illustration purpose, contents may change without notice.

Preparation

- Network connection (⇒ 17, 20)

To enjoy video communication (e.g., Skype™)

- Connect this unit with optional Communication Camera (TY-CC20W or TY-CC10W). Depending on the area, this optional camera may not be available. Please consult your local Panasonic dealer for advice.

e.g.,

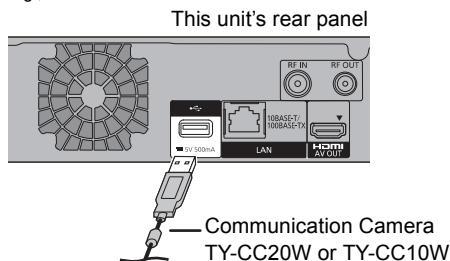

- For operating method refer to the following website.
<http://panasonic.jp/support/global/cs/>
(This site is in English only.)
- Cannot be used while recording, copying, or playing BD-Video.

- 1 Press [INTERNET].
The message is displayed. Please read it carefully and then press [OK].
 - The video communication service can be accessed directly by pressing [S] button.
- 2 Select the item, then press [OK].
 - Operable buttons:
[▲], [▼], [◀], [▶], [OK], [RETURN ⊕], colour buttons and number buttons.

To exit from VIERA Connect

Press [EXIT ⊗].



- When playing content from a disc, SD card or USB device VIERA Connect cannot be accessed.
- In the following cases, settings are possible using "Network Service Settings" (⇒ 68, 78)
 - When restricting the use of VIERA Connect.
 - When the audio is distorted.
- If using slow Internet connection, the video may not be displayed correctly. A high-speed Internet service with a speed of at least 6 Mbps is recommended.
- Be sure to update the software (firmware) when a software (firmware) update notice is displayed on the screen. If the software (firmware) is not updated, you will not be able to use the VIERA Connect function.
- The services through VIERA Connect are operated by their respective service providers, and service may be discontinued either temporarily or permanently without notice. Therefore, Panasonic will make no warranty for the content or the continuity of the services.
- All features of websites or content of the service may not be available.
- Some contents may be inappropriate for some viewers.
- Some contents of VIERA Connect may only be available for specific countries and may be presented in specific languages.
- If timer recording starts, VIERA Connect will stop.

Playback menu

1 Press [DISPLAY].

e.g.,

Disc	Soundtrack	1 ENG	<input checked="" type="checkbox"/> Digital 2/0 ch
Play	Subtitles	Off	1 ENG
Picture	Angle		1
Sound			
Other			

Menu
Item
Setting

2 Select the menu, then press [▶] (right).

3 Select the item, then press [▶] (right).

4 Select the setting.

- Some items can be changed by pressing [OK].

Depending on the condition of the unit (playing, stopped, etc.) and media contents, there may be some items which cannot be selected or for which the effects do not work properly.

To clear the Playback menu

Press [DISPLAY].

Disc

Video

The original video recording method (MPEG-4 AVC etc.) appears.

Signal Type

- **Primary Video**
 - **Video**
The original video recording method appears.
 - **Soundtrack**
Select the type of audio or language.
- **Secondary Video**
 - **Video**
Select on/off of images.
The original video recording method appears.
 - **Soundtrack**
Select on/off of audio and the language.

Soundtrack*

Show or change the soundtrack.

Subtitles*

Turn the subtitle on/off, and change the language depending on the media.

Audio Selection

Switch in the case of multiple audio.

Subtitle Style

Select the subtitle style recorded on the disc.

Angle*

Change the number to select an angle.

Audio Channel

Change audio (LR/L/R) during playback.

* With some discs, you may only be able to make changes using the menus on the disc.

Play

Repeat Play

Select the item which you want to repeat.

Random

Select whether to play random or not.

Graphic Display Level

You can change the 3D position of the playback settings display, etc., during the 3D playback.

Picture

Mode

Select the picture quality mode during play.

- **Normal**
Default setting
- **Soft**
Soft picture with fewer video artifacts
- **Fine**
Details are sharper
- **Cinema**
Mellows movies, enhances detail in dark scenes.
- **Cartoon**
A mode suitable for viewing animations.

Advanced Settings

• HD optimizer

This will compensate the mosaic noise in the video and haze around the characters precisely.

• Chroma Process

The high-resolution processing of HDMI chroma signals produces a high-resolution picture with rich picture quality.

• Detail Clarity

The picture becomes sharp and detailed.

• Super Resolution

Standard picture quality video is corrected to sharp and crisp picture quality when it is output as 1080i/1080p from the HDMI terminal.

Progressive

Select the method of conversion for progressive output to suit the type of title being played.

• Auto

Automatically detects the film and video content, and appropriately converts it.

• Video

Select this setting when the content is distorted if "Auto" is selected.

• Film

Select this if the edges of the film content appear jagged or rough when "Auto" is selected.

However, if the video content is distorted as shown in the illustration to the right, then select "Auto".

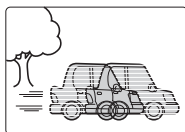

Sound

Sound Effects

• This function is effective when "Digital Audio Output" is set to "PCM". (⇒ 75)

• Re-master 1/Re-master 2

Sound becomes more natural by adding higher frequency signals not recorded on the track.

Dialogue Enhancer

The volume of the centre channel is raised to make dialogue easier to hear.

Other

Position

Change the position where this menu screen appears on your TV.

Audio attribute

LPCM/Digital/

Digital+/
TrueHD/DTS/
DTS-HD/MPEG: Signal type

k (kHz): Sampling frequency

b (bit): Number of bits

ch (channel): Number of channels

Language

ENG: English CHI: Chinese

FRA: French KOR: Korean

DEU: German MAL: Malay

ITA: Italian VIE: Vietnamese

ESP: Spanish THA: Thai

NLD: Dutch POL: Polish

SVE: Swedish CES: Czech

NOR: Norwegian SLK: Slovak

DAN: Danish HUN: Hungarian

POR: Portuguese FIN: Finnish

RUS: Russian *: Others

JPN: Japanese



• The menu is not displayed when playing photos.

Changing the unit's settings

You can change the unit's settings of Digital TV Tuning, Sound, Display, Connection, Network etc. in the menu.

Common procedures

1 Press [SETUP].

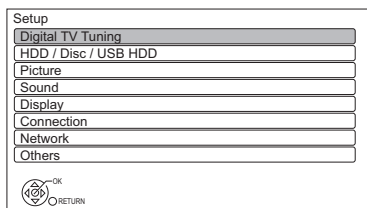

2 Select the menu, then press [OK].

3 Select the item, then press [OK].

4 Select the option, then press [OK].

- Follow the instructions on the screen if further operations are necessary.
- Depending on the connection or the status of this unit some items cannot be selected or changed.

Menu list

The locations of the setting items are as follows. For details on each setting item, please refer to the following pages.

Digital TV Tuning

- Favourites Edit (⇒ 70)
- Channel List (⇒ 71)
- Auto Setup (⇒ 71)
- Download from TV (⇒ 71)
- Manual Tuning (⇒ 71)
- Update Channel List (⇒ 71)
- Child Lock (Parental Rating) (⇒ 71)
- Signal Condition (⇒ 72)
- New Channel Message (⇒ 72)

HDD / Disc / USB HDD

- Settings for Playback (⇒ 72)
 - 3D BD-Video Playback (⇒ 72)
 - Soundtrack (⇒ 72)
 - Subtitles (⇒ 72)
 - Menu (⇒ 72)
 - Play Video (AVCHD) on BD-RE / BD-R (⇒ 73)
 - BD-Live (⇒ 73)
 - BD-Video Parental Control (⇒ 73)
 - DVD-Video Parental Control (⇒ 73)
- Timer Record Start Buffer (⇒ 73)
- Timer Record Stop Buffer (⇒ 73)
- REWIND LIVE TV (⇒ 73)
- HDD Management (⇒ 73)
 - Delete all titles (⇒ 73)
 - Delete all photos (⇒ 73)
 - Format HDD (⇒ 73)
- Settings for USB HDD (⇒ 74)
 - USB HDD Registration (⇒ 74)
 - USB HDD Disconnection (⇒ 74)
 - USB HDD Management (⇒ 74)
 - Delete all titles (⇒ 74)
 - Format USB HDD (⇒ 74)
 - Cancellation of all USB HDD Registrations (⇒ 74)

Picture

- Still Mode (⇒ 74)
- Seamless Play (⇒ 74)
- NTSC Video Output (⇒ 74)

Sound

- Dynamic Range Compression (⇒ 75)
- Downmix (⇒ 75)
- Digital Audio Output (⇒ 75)
 - PCM Down Conversion (⇒ 75)
 - Dolby D / Dolby D + / Dolby TrueHD (⇒ 75)
 - DTS / DTS-HD (⇒ 75)
 - MPEG (⇒ 75)
 - BD-Video Secondary Audio (⇒ 75)
- Audio Delay (⇒ 75)
- Audio Type for Digital Broadcast (⇒ 75)

Display

- On-Screen Information (⇒ 76)
- Unit's Display (⇒ 76)
- Screen Saver (⇒ 76)
- Teletext (⇒ 76)

Connection

- 3D Settings (⇒ 76)
 - 3D Type (⇒ 76)
 - 3D AVCHD Output (⇒ 76)
 - 3D Playback Message (⇒ 76)
- TV Aspect (⇒ 76)
- Aspect for 4:3 Video (⇒ 76)
- TV System (⇒ 76)
- HDMI Connection (⇒ 77)
 - HDMI Video Format (⇒ 77)
 - 24p Output (⇒ 77)
 - Deep Colour Output (⇒ 77)
 - HDMI Audio Output (⇒ 77)
 - 7.1ch Audio Reformatting (⇒ 77)
 - Contents Type Flag (⇒ 77)
 - VIERA Link (⇒ 77)

Network

- Easy Network Setting (⇒ 78)
- Network Settings (⇒ 78)
 - LAN Connection Mode (⇒ 78)
 - Wireless Settings (⇒ 78)
 - Connection Setting (⇒ 78)
 - Double Speed Mode Setting (2.4GHz) (⇒ 78)
 - IP Address / DNS Settings (⇒ 78)
 - Proxy Server Settings (⇒ 78)
 - Network Service Settings (⇒ 78)
 - Lock (⇒ 78)
 - Automatic Volume Control (⇒ 78)
 - Home Network Settings (⇒ 79)
 - Home Network function (⇒ 79)
 - Setting device name (⇒ 79)
 - Registration type for remote devices (⇒ 79)
 - Remote device list (⇒ 79)

Others

- Standby Settings (⇒ 79)
 - Power Save in Standby (⇒ 79)
 - Automatic Standby (⇒ 79)
 - Automatic Standby after OTR (⇒ 79)
 - Automatic Standby after Copy (⇒ 80)
 - RF OUT (Aerial Signal) (⇒ 80)
- Remote Control (⇒ 80)
- Clock (⇒ 80)
- PIN Entry (⇒ 80)
- System Update (⇒ 80)
 - Software Update in Standby (⇒ 80)
 - Software Update Now (Broadcast) (⇒ 80)
 - Software Update Now (Internet) (⇒ 80)
 - Software Licence (⇒ 80)
- System Information (⇒ 81)
- DivX Registration (⇒ 81)
- Initialize (⇒ 81)
 - Shipping Condition (⇒ 81)
 - Default Settings (⇒ 81)

Changing the unit's settings

About the PIN

PIN is required to change the following settings. Enter the 4-digit PIN following the on-screen instructions.

- The PIN is common for the following items.
 - Child Lock (Parental Rating)
 - BD-Video Parental Control
 - DVD-Video Parental Control
 - Lock (Network Service Settings)

PIN can be changed via the "PIN Entry" in "Others". (⇒ 80)

- 1 Select the number, then press [▶] (right).
 - You can also use the number buttons.
- 2 Repeat step 1 to enter 4-digit PIN.
- 3 Press [OK].

e.g., PIN Entry

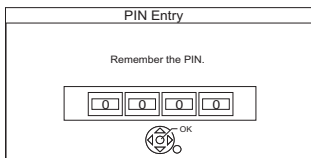

- **Make a note of PIN in case you forget it.**

Digital TV Tuning

Favourites Edit

You can create four favourites of channels for making viewing and recording easier.

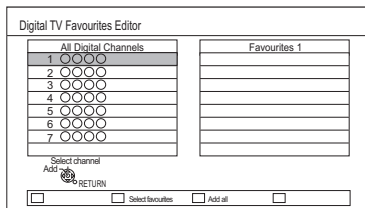

- To select the other Favourites list:
Press the green button.
- To add channels to the Favourites list:
Select the channel in the "All Digital Channels" column, then press [OK]. Repeat this step.
 - Yellow: Add all the available channels to the Favourites. (This function is available only when there are no channels in the "Favourites".)
- To change the order of the channels list:
 - 1 Select the channel in the "Favourites" column to move, then press the green button.
 - 2 Select the new position, then press the green button.
- To delete channels:
Select the channel in the "Favourites" column, then press [OK].
 - Yellow: Delete all channels.
- To change the name of the Favourites list:
 - 1 Press the red button in the "Favourites" column.
 - 2 Press [▲, ▼, ◀, ▶] to select a character, then press [OK].
Repeat this step to enter other characters.
 - Red: Delete a character.
 - Blue: Delete all characters.
 - 3 Press [RETURN ⊕].

Channel List

You can edit the Channel List.

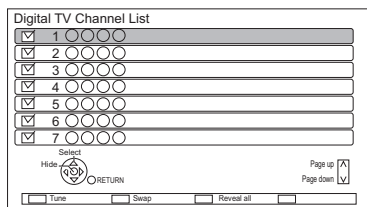

- To hide unwanted channels
 - 1 Select the channel.
 - 2 Press [OK].
 - The check mark is removed.
 - Yellow: Reveal all channels.
- To change the channel number assignment
 - 1 Select the channel, then press the green button.
 - 2 Enter the channel number to reassign with the number buttons.
 - 3 Press [OK].
 - If another channel is already assigned to the channel number, the two channels will be switched.
- To set the channel manually
 - 1 Press the red button.
 - 2 Refer to "Manual Tuning". (⇒ right)

Auto Setup

You can restart the Auto Setup. (⇒ 19)
Select "Yes", then press [OK].

Download from TV

Select "Download from TV" when you connect the unit to a VIERA Link (HDAVI Control 3 or later) compatible TV with an HDMI cable.
Select "Yes", then press [OK].

Manual Tuning

You can add new channels manually.

- 1 Select the channel.
- 2 Adjust the frequency.
 - Adjust the frequency by checking the signal strength and signal quality displays.
- 3 Press [OK] to start scan.
 - The set channel is displayed in the table.

Update Channel List

You can update the channel list to the latest one.

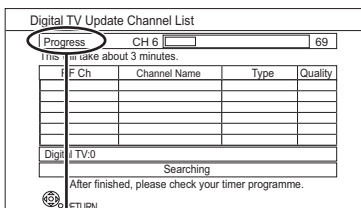

Press [RETURN] when search is finished and "Finished" is displayed.



- After performing "Update Channel List" or "Manual Tuning" if the channel number has already been assigned, channel number for them will be assigned from 800ch onward.

Child Lock (Parental Rating)

You can restrict the viewing of channels unsuitable to children.

Set a ratings level to limit broadcast viewing and playback.

- PIN is required to change. (⇒ 70)

Changing the unit's settings

Signal Condition

You can check the quality and strength of signals.

Press [CH ^ v] to select the channel.

Digital TV Signal Condition	
Channel Name	○○○○
Signal Quality	■■■■
Signal Strength	0 2 4 6 8 10
Network Name	○○○○○○○○
RF Parameter	10001000MHz
<input type="checkbox"/> Good	Channel Up [▲]
<input type="checkbox"/> Poor	Channel Down [▼]
<input type="checkbox"/> Bad	

- Signal Quality:
Red bar: Bad
Yellow bar: Poor
Green bar: Good
- Signal Strength:
"0": 0%
"10": 100%



- The channels you can receive are affected by weather conditions, seasons, time (day/night), region, length of the cable that is connected to the aerial, etc.
- When the signal is too strong (red bar), reduce the signal amplification at your aerial.

New Channel Message

Set whether to obtain the information automatically when a new DVB channel is added.

HDD / Disc / USB HDD

Settings for Playback

3D BD-Video Playback

Select the playback method of 3D compatible video software.

Soundtrack

Select the audio language.

- If "Original" is selected, the original language of each disc will be selected.
- Enter a code with the number buttons when you select "Other * * * *".
(⇒ 81, Language code list)

Subtitles

Select the language for subtitle.

- If "Automatic" is selected and the language selected for "Soundtrack" is not available, subtitles of that language will automatically appear if available on that disc.
- Enter a code with the number buttons when you select "Other * * * *".
(⇒ 81, Language code list)

Menu

Select the language for disc menus.

- Enter a code with the number buttons when you select "Other * * * *".
(⇒ 81, Language code list)

Play Video (AVCHD) on BD-RE / BD-R

When playing a disc which contains the following two video formats;

- High Definition video (AVCHD) recorded by the Panasonic video camera, etc.
- High Definition quality video recorded on this unit,

select which video to play back.

- On:
Play the High Definition video (AVCHD)
- Off:
Play the High Definition quality title

BD-Live

You can restrict Internet access when BD-Live functions are used.

- If "On (Limit)" is selected, Internet access is permitted only for BD-Live contents which have content owner certificates.

BD-Video Parental Control

Set an age limit of BD-Video play.

- PIN is required to change. (⇒ 70)

DVD-Video Parental Control

Set a rating level to limit DVD-Video play.

- PIN is required to change. (⇒ 70)

Timer Record Start Buffer

This function sets the timer recording to start earlier than the TV Guide time.

Timer Record Stop Buffer

This function sets the timer recording to stop later than the TV Guide time.

REWIND LIVE TV

Turn on/off the REWIND LIVE TV function.

- When "Automatic Standby" is set to "Off" (⇒ 79), "On" cannot be selected.

HDD Management

Press and hold [OK] for 3 seconds to show the following settings.

Delete all titles

Delete all titles (video) on the built-in HDD.

- Delete does not work if one or more titles are protected.

Delete all photos

Delete all photos on the built-in HDD.

Format HDD

Formatting deletes all contents on the built-in HDD, and they cannot be restored. Check carefully before proceeding.

Changing the unit's settings

Settings for USB HDD

USB HDD Registration

Register the USB HDD. (⇒ 62)

USB HDD Disconnection

This function puts the USB HDD in a state in which it can be safely disconnected. (⇒ 62)

USB HDD Management

Press and hold [OK] for 3 seconds to show the following settings.

Delete all titles

Delete all titles on the USB HDD.

- Delete does not work if one or more titles are protected.

Format USB HDD

Formatting deletes all contents, and they cannot be restored. Check carefully before proceeding.

Cancellation of all USB HDD Registrations

This function cancels the registrations of all the USB HDDs registered on this unit.

Only do this if you are going to dispose of this unit.



- Before operation, perform "USB HDD Disconnection" (⇒ above) and remove the USB HDD.
- It is not possible to play back the content from a USB HDD whose registration has been cancelled.

Picture

Still Mode

Select the type of picture shown when you pause play.

- Field:
Select if jittering occurs when "Automatic" is selected. (The picture is coarser.)
- Frame:
Select if small text or fine patterns cannot be seen clearly when "Automatic" is selected. (The picture is clearer and finer.)

Seamless Play

The segments can be played back seamlessly.

- When "Off" is selected, frame-dropping between the segments can be avoided, but the video may freeze for a moment between the segments.
- Seamless Play function does not work depending on the condition or the kind of programme.

NTSC Video Output

(This works only for video output from the VIDEO OUT terminal.)

Select how to output the NTSC image.

Sound

Dynamic Range Compression

To lower the dynamic range for playback (e.g., at night).

- This does not work depending on broadcasts and recorded titles.

Downmix

Select the downmix system of multi-channel to 2-channels sound.

- Select "Surround encoded", when the connected equipment supports the virtual surround function.
- There is no effect on "Bitstream" via HDMI AV OUT and DIGITAL AUDIO OUT terminal.
- The audio will be output in "Stereo" in the following cases.
 - AVCHD playback
 - **[BD-V]**: Playback of clicking sound on the menu and audio with secondary video in picture-in-picture mode.

Digital Audio Output

PCM Down Conversion

Select how to output audio with a sampling frequency of 96 kHz.

- On:

Signals are converted to 48 kHz.
(Choose when the connected equipment cannot process signals with a sampling frequency of 96 kHz.)
- Off:

Signals are output as 96 kHz

 - The signals will be converted to 48 kHz regardless of the setting in the following cases.
 - The signals have a sampling frequency of over 96 kHz.
 - The disc has copy protection.
 - "BD-Video Secondary Audio" is set to "On". (**[BD-V]**) (⇒ right)

Dolby D / Dolby D + / Dolby TrueHD DTS / DTS-HD MPEG

Select the audio signal to output.

- Select "PCM" when the connected equipment cannot decode the respective audio format.
- Not making the proper settings may result in noise.

BD-Video Secondary Audio

Turn on/off the clicking sound on the menu and audio with secondary video.

Audio Delay

Mis-sync between the video and audio is corrected by delaying the audio output.

Audio Type for Digital Broadcast

If the programme has more than one track (Dolby Digital, MPEG, etc.), you can set priorities.

- This setting will give effect in the following conditions.
 - The default setting when watching broadcasts.
 - The default setting when playing back the title.

Changing the unit's settings

Display

On-Screen Information

Select the time until the channel information screen (⇒ 24) disappears automatically.

Unit's Display

Changes the brightness of the unit's display.

Screen Saver

This is to prevent burn-in on the screen.

Teletext

Select the Teletext (⇒ 25) display mode.

Connection

3D Settings

3D Type

If 3D video cannot be played back in 3D, you may be able to play it in 3D by changing the setting.

- Change the settings for 3D on the TV also when "Side by side" is selected.
- This setting is not effective for 3D BD-Video.

3D AVCHD Output

If 2D AVCHD video is recognised as 3D video and cannot be played back correctly, you may be able to play it by changing the setting.

3D Playback Message

Set to display or hide the 3D viewing warning screen.

TV Aspect

Set to match the type of TV connected.

- Pan & Scan:

Side picture is trimmed for 16:9 picture.

The pictures may be shown in the letterbox style depending on the content.



- Letterbox:

Black bands appear for 16:9 picture.



Aspect for 4:3 Video

To play a 4:3 title, set how to show pictures on a 16:9 TV.

TV System

Set in accordance with the TV System for the connected TV.

HDMI Connection

HDMI Video Format

You can only select items compatible with the connected equipment.

- If "Automatic" is selected, the output resolution best suited to the connected TV (1080p, 1080i, 720p or 576p/480p) is automatically selected.
- To enjoy High Quality Video up-converted to 1080p, you need to connect the unit to 1080p compatible HDTV. If this unit is connected to an HDTV through other equipment, it must also be 1080p compatible.

24p Output

When playing BD-Video recorded in 24 frames, this unit displays each frame at 1/24 second intervals—the same interval originally shot with the film movie.

- This item is effective only when this unit is connected to a TV supporting 1080/24p output using an HDMI cable and "HDMI Video Format" is set to "Automatic" or "1080p". (⇒ above)
- When BD-Video images other than 24p are played, images are output at 60p.

Deep Colour Output

This setting is for selecting whether to use Deep Colour output when a TV that supports Deep Colour is connected.

HDMI Audio Output

Select "Off" when connected to a TV with an HDMI cable, and connected to an amplifier/receiver not compatible with HDMI with a DIGITAL AUDIO OUT terminal.

7.1ch Audio Reformatting

BD-V

Surround sound with 6.1 ch or less is automatically expanded and played back at 7.1 ch.

- If "Off" is selected, sound is played over the original number of channels. (Note that in the case of 6.1 ch audio, playback will be at 5.1 ch)

Audio reformatting is enabled in the following cases:

- When you have selected "PCM" in "Digital Audio Output".
- When the audio is Dolby Digital, Dolby Digital Plus, Dolby TrueHD or LPCM.

Contents Type Flag

If "Automatic" is selected, the optimal method of playback depending on the TV (e.g. cinema) will automatically be selected (only when the TV supports Contents Type Flag).

VIERA Link

Select "Off" when you do not want to use "HDAVI Control".

Changing the unit's settings

Network

Easy Network Setting

Press [OK] to start Easy Network Setting. (⇒ 20)

Network Settings

LAN Connection Mode

Select the LAN connection method.

Wireless Settings

This allows to set and check the connection settings of the Wireless router.

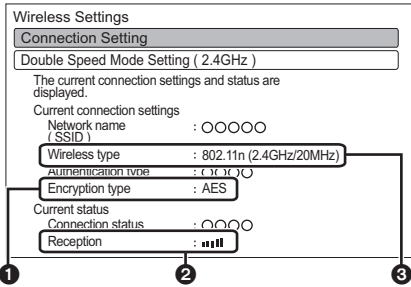

- ① Encryption type
- ② Reception
- ③ Type of wireless router

Connection Setting

The Wireless router connection wizard will be displayed.

Double Speed Mode Setting (2.4GHz)

When a 2.4 GHz wireless format is used, this setting sets the connection speed.

- If you connect using the “Double Speed Mode (40MHz)”, 2 channels use the same frequency band, and there is consequently a greater risk of reception interference. This can cause the connection speed to drop or the connection to become unstable.

IP Address / DNS Settings

Check the connection of the network or set the IP address and DNS.

- Press [OK] to show the respective setting.
- If you set “IP Address”, “Subnet Mask” and “Gateway Address” individually, make their settings after setting “IP Address Auto-assignment” to “Off”.

When the router’s DHCP server function is not activated, check the numbers of other connected devices such as personal computers, then assign a number different from those of other devices for the “IP Address” and assign the same number for “Subnet Mask” and “Gateway Address”.

Proxy Server Settings

Check and set the connection to the Proxy server.

- Press [OK] to show the respective setting.

Network Service Settings

Lock

You can restrict using VIERA Connect.

- PIN is required to change. (⇒ 70)

Automatic Volume Control

Volume is adjusted automatically to the standard volume while using VIERA Connect.

- Depending on contents, this function will not work.
- Select “Off” when the audio is warped.

Home Network Settings

You can set the DLNA (Server) function.
(⇒ 58)

Home Network function

You can switch between enable/disable of the DLNA (Server) and DMR (Media Renderer) function.

- If “On” is selected, “Power Save in Standby” is fixed to “Off”. (⇒ 79)

Setting device name

It is also possible to change the name of this unit on the network.

- Select from a preset list
Select the preset name, then press [OK].
- Create name
Enter the name.
Refer to “Entering text”. (⇒ 83)

Registration type for remote devices

- Automatic:
All connected devices on the same network can access this unit.
- Manual:
Only registered devices can access this unit.

Remote device list

- To register equipment manually
 - 1 Select the device name or the MAC Address for the device you want to register, then press [OK].
 - 2 Select “Yes”, then press [OK].
- To deregister equipment
 - 1 Select the registered equipment, then press [OK].
 - 2 Select “Yes”, then press [OK].



- This function cannot be enabled when “Automatic” is selected in “Registration type for remote devices”. (⇒ above)
- The maximum number of equipment that can be registered is 16.

Others

Standby Settings

Power Save in Standby

- On:
It will go into the “Power Save in Standby” mode.
- On Timer:
“Power Save in Standby” is activated when the set time comes.
 - If the clock has not been set, “Power Save in Standby” is activated at all hours.
- Off:
It is possible to start quickly from standby mode. (Quick Start mode)



- This function cannot be enabled when the DLNA function is enabled in “Home Network function”. (⇒ left)
- The setting may be changed to “Off” automatically when the setting for video communication is changed. (⇒ 65)

Automatic Standby

Set the time to turn the unit to standby mode automatically.

When the unit is not operating, the unit will be turned to standby mode once the set time has passed.

- When “REWIND LIVE TV” is set to “On” (⇒ 73), “Off” cannot be selected.

Automatic Standby after OTR

- On:
This unit is turned to standby mode when it is not operated for approximately 5 minutes after completing “Automatic Stop” or “Recording Time” (⇒ 27).

Changing the unit's settings

Automatic Standby after Copy

- On:
This unit is turned to standby mode when it is not operated for approximately 5 minutes after completing copy (⇒ 57).

RF OUT (Aerial Signal)

Set whether to output the aerial signal or not from RF OUT while in standby mode (When "Power Save in Standby" is activated).

- If "On" is selected, the aerial signal is output from this unit.

Remote Control

Change the remote control code on the main unit and the remote control if you place other Panasonic products close together.

- Use "Set Code 1", the factory set code, under normal circumstances.
- 1 Select the code, then press [OK].
 - 2 While pressing [OK], press and hold the number button ([1] to [6]) for more than 5 seconds.
 - 3 Press and hold [OK] for more than 5 seconds.
 - 4 Press [OK].
- Operation is possible only with Panasonic remote controls with "IR6" printed at the bottom when the remote control code of this unit is set to "Set Code 4", "Set Code 5" or "Set Code 6".

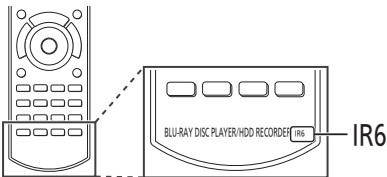

Clock

If the time is not set correctly, use the settings listed in the method below.

- Automatic
This unit usually obtains time and date information from digital broadcasts.
- Region Selection
Select the region where you live to adjust the standard time.
 - The time contained in the broadcast signal is UTC (Universal time, coordinated).
- Daylight Saving Time
Select time offset from the standard time for Summer Time.
 - If there is a gap between displayed time and actual time, set this function.
- Manual Setting
 - 1 Select "Off" of "Automatic", then press [OK].
 - 2 Select the item you want to change.
 - 3 Change the setting.
 - 4 Press [OK] when you have finished the settings.

PIN Entry

You can set/change the PIN. (⇒ 70)

System Update

Software Update in Standby

When you set this unit to standby mode, software (firmware) updates (⇒ 82) are downloaded automatically at the time you have specified.

Software Update Now (Broadcast)

Refer to "Software (Firmware) Update". (⇒ 82)

Software Update Now (Internet)

Refer to "Software (Firmware) Update". (⇒ 82)

Software Licence

Information about the software licence is displayed.

System Information

Display software (firmware), HDAVI Control version and Wireless Module version (When using wireless connection only) of this unit.

DivX Registration

You need this registration code to purchase and play DivX Video-on-Demand (VOD) content.

- After playing DivX VOD content for the first time, the registration code is not displayed.
- If you purchase DivX VOD content using a registration code different from this unit's code, you will not be able to play this content.
- To cancel the unit's registration
Select "Yes".
Use the deregistration code to cancel the registration in www.divx.com.

Initialize

Shipping Condition

All the settings except for basic settings return to the factory preset. The timer recording programmes are also cancelled.

Default Settings

All the settings other than the tuning settings, clock settings, disc language settings, rating PIN, remote control code, etc. return to the factory presets.

Language code list

Abkhazian:	6566	Lingala:	7678
Afar:	6565	Lithuanian:	7684
Afrikaans:	6570	Macedonian:	7775
Albanian:	8381	Malagasy:	7771
Amharic:	6577	Malay:	7783
Arabic:	6582	Malayalam:	7776
Armenian:	7289	Maltese:	7784
Assamese:	6583	Maori:	7773
Aymara:	6589	Marathi:	7782
Azerbaijani:	6590	Moldavian:	7779
Bashkir:	6665	Mongolian:	7778
Basque:	6985	Nauru:	7865
Bengali, Bangla:	6678	Nepali:	7869
Bhutani:	6890	Norwegian:	7879
Bihari:	6672	Oriya:	7982
Breton:	6682	Pashto, Pushto:	8083
Bulgarian:	6671	Persian:	7065
Burmese:	7789	Polish:	8076
Byelorussian:	6669	Portuguese:	8084
Cambodian:	7577	Punjabi:	8065
Catalan:	6765	Quechua:	8185
Chinese:	9072	Rhaeto-Romance:	8277
Corsican:	6779	Romanian:	8279
Croatian:	7282	Russian:	8285
Czech:	6783	Samoan:	8377
Danish:	6865	Sanskrit:	8365
Dutch:	7876	Scots Gaelic:	7168
English:	6978	Serbian:	8382
Esperanto:	6979	Serbo-Croatian:	8372
Estonian:	6984	Shona:	8378
Faroese:	7079	Sindhi:	8368
Fiji:	7074	Singhalese:	8373
Finnish:	7073	Slovak:	8375
French:	7082	Slovenian:	8376
Frisian:	7089	Somali:	8379
Galician:	7176	Spanish:	6983
Georgian:	7565	Sundanese:	8385
German:	6869	Swahili:	8387
Greek:	6976	Swedish:	8386
Greenlandic:	7576	Tagalog:	8476
Guarani:	7178	Tajik:	8471
Gujarati:	7185	Tamil:	8465
Hausa:	7265	Tatar:	8484
Hebrew:	7387	Telugu:	8469
Hindi:	7273	Thai:	8472
Hungarian:	7285	Tibetan:	6679
Icelandic:	7383	Tigrinya:	8473
Indonesian:	7378	Tonga:	8479
Interlingua:	7365	Turkish:	8482
Irish:	7165	Turkmen:	8475
Italian:	7384	Twi:	8487
Japanese:	7465	Ukrainian:	8575
Javanese:	7487	Urdu:	8582
Kannada:	7578	Uzbek:	8590
Kashmiri:	7583	Vietnamese:	8673
Kazakh:	7575	Volapük:	8679
Kirghiz:	7589	Welsh:	6789
Korean:	7579	Wolof:	8779
Kurdish:	7585	Xhosa:	8872
Laotian:	7679	Yiddish:	7473
Latin:	7665	Yoruba:	8979
Latvian, Lettish:	7686	Zulu:	9085

Software (Firmware) Update

You cannot operate the unit until the update is complete. Don't remove the AC mains lead during the update. Removing the AC mains lead while the update is in progress may damage the unit.

If a software (firmware) update is available, a notification is displayed.

New software version has been found.
The software will be updated automatically after this unit is switched to standby.
Do not disconnect the AC mains lead.

Software of this unit can be updated automatically by the following methods at the specified time. (Default setting is 3 a.m. ⇒ 80, Software Update in Standby)

- From broadcasts
- From Internet*

- It is displayed on the channel information (⇒ 24) when the Software (Firmware) can be updated immediately.

e.g.,

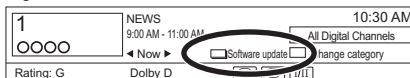

To execute, press the red button while the channel information is displayed, and follow the instructions on the screen.

- To update the software (Firmware) immediately, use the following function:

- Software Update Now (Broadcast):
 - Software of this unit will be updated from broadcasts if update information is detected.
- Software Update Now (Internet)*:
 - Software of this unit will be updated from Internet if update information is detected.

Update of the software (firmware) will start when the unit is turned to standby mode.

* Network connection and setting are required. (⇒ 17, 20)

The unit's display during the update

e.g.,

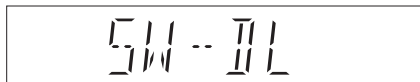

- When "FINISH" is displayed, update of the software (firmware) has completed.



- It may take up to a few hours until the update is completed depending on the network or broadcast environment.
- The timer recording always takes preference over the software (Firmware) download; if the timer recording is scheduled to start, the downloading will be performed at the next opportunity.
- You can also download the latest software (firmware) from the following website.
<http://panasonic.jp/support/global/cs/>

Other operations

Entering text

Preparation

- Show the "Enter Title Name" screen, etc.

- Select a character, then press [OK].
Repeat this step to enter other characters.

e.g.,

Name field: shows the text you have entered

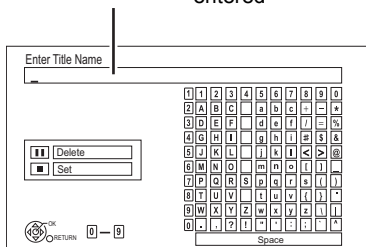

- To delete a character:
Select the character in the name field, then press [PAUSE ■].

- To enter characters with number buttons:
e.g., entering the letter "R"

- Press [7] to move to the seventh row.
- Press [7] twice to highlight "R".
- Press [OK].

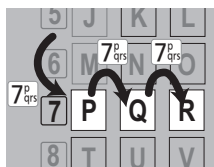

- Press [STOP ■] (Set).
"Writing..." appears then the screen returns to the previous screen and so on.

To end partway

Press [RETURN ⊕]. (Text is not added.)



- If a name is long, parts of it may not be shown in some screens.

Switching the aspect ratio of the screen

When the image does not match the screen size of the TV, you can enlarge the image to fill the screen.

- Press [OPTION].
- Select "Aspect", then press [OK].
- Select the item, then press [OK].

Normal:

Normal output

Side cut:

The black bars on the right and left sides of the 16:9 image disappear and the image is enlarged.

Zoom:

The black bars on the top and bottom sides of the 4:3 image disappear and the image is enlarged.



- This function does not work when watching 3D programme and playing back 3D title or 3D photo.
- It may also be adjusted using the screen mode of the TV etc.
- The screen mode is switched to "Normal" in the following situations:
 - when you change the channel
 - when you start or end the playback of a title
 - when you switch the unit on or to standby mode.
- [BD-V] [DVD-V] "Side cut" does not have any effect.
- When "TV Aspect" (⇨ 76) is set to "Pan & Scan" or "Letterbox", the "Zoom" effect is disabled.

HOLD function

The HOLD function deactivates all buttons on the unit and remote control.

Press and hold [OK] and [RETURN ⊕] simultaneously until "X HOLD" appears on the unit's display.

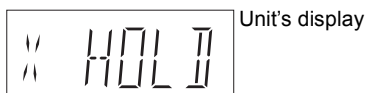

To cancel the HOLD function

Press and hold [OK] and [RETURN ⊕] simultaneously until "X HOLD" disappears.

Troubleshooting guide

Before requesting service, make the following checks. If the problem still persists, consult your dealer for instructions.

Updating to the latest software (firmware) may solve the problem. (⇒ 82)

The followings do not indicate a problem with this unit:

- Regular disc rotating sounds or HDD rotating sounds.
- Poor reception due to atmospheric conditions.
- Image disturbance during search.
- Image disturbance when replacing 3D discs.
- Interruptions in reception due to periodic broadcasting breaks.
- When you switch the unit on or to standby mode, there may be an unexpected sound.

General operation

The unit does not work.

- Check the connections. (⇒ 13)
- One of the unit's safety devices may have been activated.

Reset the unit as follows:

- 1 Press [⏻/|] on the main unit to switch the unit to standby.
 - If the unit does not switch to standby, press [⏻/|] on the main unit for about 3 seconds. The unit is forcibly switched to standby. Alternatively, disconnect the AC mains lead, wait one minute, then reconnect it.
- 2 Press [⏻/|] on the main unit to switch it on. If the unit still cannot be operated, consult the dealer.

Cannot eject a disc.

- 1 While the unit is in standby mode, press and hold [OK], the yellow button and the blue button at the same time for more than 5 seconds.
 - "00 RET" is displayed on the unit's display.
- 2 Repeatedly press [▶] (right) until "06 FTO" is displayed on the unit's display.
- 3 Press [OK].

The unit is switched to standby mode automatically.

- VIERA Link has worked. (⇒ 64, Power off link)

The remote control does not work.

- The remote control and main unit are using different codes. Change the code on the remote control.



Unit's display

Press and hold [OK] and the indicated number button at the same time for more than 5 seconds. (⇒ 80)

- Software (firmware) is updating when "UPD □/□" is displaying on the unit's display. Wait until the update is completed. (⇒ 82)
- The HOLD function is activated. (⇒ 83)

Startup is slow.

- Startup takes time in the following situations:
 - A disc is inserted.
 - The clock is not set.
 - Immediately after a power failure or the AC mains lead is connected.
 - When a BD-J application is executing.
 - When the "Power Save in Standby" is activated. (⇒ 79)

Displays

"0:00" is flashing on the unit's display.

- Set the clock. (⇒ 68, 80)

The clock does not display on the unit when switched to standby.

- The clock does not display when "Power Save in Standby" is activated. (⇒ 79)

TV screen and video

Screen size is wrong.

- Check the "TV Aspect" or "Aspect for 4:3 Video". (⇒ 76)
- Adjust the aspect ratio setting on TV.
- If you connect to 4:3 TV, set "HDMI Video Format" to "576p/480p". (⇒ 68, 77)

The black screen appears on the TV.

- This phenomenon may occur, depending on the TV setting, when "Power Save in Standby" is set to "Off". Depending on the TV, this phenomenon may be prevented by reconnecting to a different HDMI input terminal.

TV reception is not displayed.

- Broadcast signals are not output from this unit's RF OUT terminal. Select "On" in "RF OUT (Aerial Signal)". (⇒ 68, 80)

Picture does not appear with the HD quality although HD setting was made.

- The pictures are output with 576p/480p depending on the title.

The screen changes automatically.

- If "Screen Saver" set to "On", the screen saver function will be activated when there is no operation for 5 minutes or more. (⇒ 76)

There is a lot of image lag when playing video.

- Set "HD optimizer" in the Picture menu to "Off". (⇒ 67)
- Set "Audio Delay". (⇒ 68, 75)

The images do not appear on the TV.

The picture is distorted during play, or video will not play correctly.

- Check the connections. (⇒ 13)
- Check the connected equipment's settings.
- An incorrect resolution is selected in "HDMI Video Format". Reset the setting as follows:
 - 1 While the unit is on, press and hold [OK], the yellow button and the blue button at the same time for more than 5 seconds.
 - "00 RET" is displayed on the unit's display.
 - 2 Repeatedly press [▶] (right) until "04 PRG" is displayed on the unit's display.
 - 3 Press and hold [OK] for at least 3 seconds. Set the item again. (⇒ 68, 77)
 - When Dolby Digital Plus, Dolby TrueHD, and DTS-HD audio are not output properly, select "Yes" in "Default Settings" and make proper settings. (⇒ 68, 81)
- The unit's TV System is different from that of the disc. While stopped, keep pressing [■] (STOP) and [▲ OPEN/CLOSE] on the main unit for 5 or more seconds. The system switches from PAL to NTSC or vice versa.
- Picture may not be seen when more than 4 devices are connected with HDMI cables. Reduce the number of connected devices.
- The picture may be distorted or a black screen may appear between scenes recorded with different aspect ratios.
- Set "Deep Colour Output" (⇒ 68, 77) or "Contents Type Flag" (⇒ 68, 77) to "Off".

Troubleshooting guide

3D video is not output correctly.

- Perform the 3D settings. (⇒ 40)
- When a non-3D compatible amplifier/receiver is connected between this unit and a TV, 3D video is not output. (⇒ 15)
- When the amplifier/receiver which is connected between this unit and a TV is off, 3D video is not output. (⇒ 15)
- 3D discs may not be played back correctly due to the settings of the TV.
- When "HDMI Audio Output" is set to "Off", 3D video may not be output correctly. (⇒ 77)

The same video is displayed in each left and right half of the screen.

- This is a 3D programme of the Side-by-Side type.
Change the setting as follows if connecting with a 3D compatible TV:
 - 1 Press [OPTION].
 - 2 Select "3D Settings", then press [OK].
 - 3 Select "Side by side" in "Signal Format", then press [OK].

Sound

No sound.

Distorted sound.

- Check the connections. (⇒ 13)
- Check the connected equipment's settings.
- Press [AUDIO] to select the audio. (⇒ 25, 40)
- To output audio from a device connected with an HDMI cable, set "HDMI Audio Output" to "On". (⇒ 68, 77)

Cannot change audio channel.

- You cannot change the audio channel if "Digital Audio Output" is set to "Bitstream" (⇒ 75)

Recording, timer recording and copying

Cannot record.

Cannot copy.

- Some broadcasts are copyright protected.
- You cannot record/copy to the disc.

Auto Renewal Recording does not work properly.

- The programme will not be overwritten in the following cases:
 - the programme is protected
 - any programme is being played back or copied
 - a screen such as DIRECT NAVIGATOR is displayed
 Instead, the programme will be saved as a separate programme and that will be overwritten.

A part or whole of a recorded title has been lost.

- If there is a power failure or the AC mains lead is disconnected from the household mains socket while recording or editing, the title may be lost or the HDD may become unusable. We cannot offer any guarantee regarding lost programmes.

Play

Cannot play back.

- The disc is dirty. (⇒ 9)
- The disc is scratched or marked.
- **BD-R** **BD-RE**
Set "Play Video (AVCHD) on BD-RE / BD-R" to "On" and the playback may be possible (⇒ 68, 73).
- The disc may not be able to play back if it was not finalized or a Top Menu was not created on the equipment used for recording.

Audio and video momentarily pause.

- DVD-R DL and +R DL discs have two writable layers on one side. Video and audio may momentarily cut out when the unit is switching layers.

BD-Video or DVD-Video is not played.

- Ensure the disc is for the correct BD-Video region code or DVD-Video region number, and is not defective.

You have forgotten your rating PIN.

- The rating level returns to the factory preset.
 - 1 While the unit is on, press and hold [OK], the yellow button and the blue button at the same time for more than 5 seconds.
 - “00 RET” is displayed on the unit’s display.
 - 2 Repeatedly press [▶] (right) until “03 VL” is displayed on the unit’s display.
 - 3 Press [OK].
 - “INIT” is displayed on the unit’s display.

Image for the Quick View is not smooth.

- Image may not be played back smoothly in case of High definition titles.

Edit

Cannot edit.

- You may not be able to edit on the HDD if there is no available space. Delete any unwanted titles to create empty space. (⇒ 42)

Cannot create a playlist.

- Creation or editing of playlists cannot be done on this unit.

Photo

The contents of the SD card cannot be read.

- Remove the card from the slot and then insert again. If this does not solve the problem, switch the unit to standby mode and turn it on again.

Copying, deleting and setting protection takes a long time.

- When there are a lot of folders and files, it may sometimes take a long time.

Photos do not play back normally.

- The images that were edited on the PC, such as PROGRESSIVE JPEG, etc., may not play back. (⇒ 95)

USB

This unit does not recognize the USB device correctly.

- If USB device is connected to this unit while using a video communication the USB device will not be recognized. Press [EXIT ⊗] and reconnect USB device.
- If inserted during playback the USB device may not be recognized by this unit. Disconnect and reconnect the USB device. If it still does not recognize the connection, switch the unit to standby mode and turn it on again.
- USB devices connected using a USB extension cable other than a dedicated one or a USB hub may not be recognized by this unit.

TV Guide

The TV Guide information is not displayed properly.

- Set the clock correctly. (⇒ 68, 80, Clock)
- Some broadcast may not send programme information.
- There was a programme change, or TV Guide information from a broadcast station was possibly not correctly transmitted.
- If signal quality is bad, the TV Guide system may not be able to receive any data.

Troubleshooting guide

Broadcast

Picture regularly breaks up on some channels.

- Adjust the aerial reception with “Manual Tuning”. (⇒ 68, 71)

Picture very infrequently breaks up on some or all channels.

- Electrical atmospheric interference caused by bad weather may cause pictures to break up and audio to mute or distort momentarily.

VIERA Link

VIERA Link does not work.

- Some functions may not work depending on the version of “HDAVI Control” of the connected equipment. This unit supports “HDAVI Control 5” functions.
- Check the connected equipment’s settings.
- If the connection for the equipment connected with HDMI was changed, or if there was a power failure or the plug was removed from the household mains socket, “HDAVI Control” may not work.
In this case, change TV (VIERA) setting for “HDAVI Control” again.
- This unit does not support “ONE TOUCH PLAY” function of the Panasonic AV Control Receiver.

Network

You cannot access this unit from DLNA compatible equipment on the network.

- Check the network connection and the network settings. (⇒ 17, 20)
- It may not be possible to connect depending on the types of the equipment or the status of the equipment.

You cannot play contents properly from DLNA compatible equipment on the network.

- There may be some video that cannot be played back on DLNA compatible equipment depending on the equipment.
- Following titles cannot be played back:
 - A title with access restriction
 - A title currently being recorded on this unit
 - A title with audio only format
 - A title with incompatible format
- Playback via DLNA compatible equipment may not be performed when this unit is in the following conditions:
 - While simultaneously recording two programmes
 - While playing back a BD-Video
 - While simultaneously copying and recording
 - While displaying the Setup menu
 - While executing functions using a network, such as “VIERA Connect”
- You cannot play back simultaneously from two or more items of DLNA compatible equipment.

When using Wireless LAN connection, video from the DLNA Certified media server is not played back or video frames are dropped during playback.

- Use 802.11n (2.4 GHz) Wireless router. Simultaneous use with a microwave, cordless telephone etc. at 2.4 GHz may result in connection interruptions or other problems.
- On the “Wireless Settings” screen (⇒ 78), the continuous lighting of at least four “Reception” indicators is the target for a stable connection. If three or fewer indicators are lit or the connection is being interrupted, change the position or angle of your Wireless router. If there is no improvement, connect to a wired network and perform the “Easy Network Setting” (⇒ 20) again.

Reset

To return all the settings to the factory preset

Perform "Shipping Condition" or "Default Settings". (⇒ 68, 81)

Messages on the unit's display

The following messages or service numbers appear on the unit's display when something unusual is detected.

SET □

("□" stands for a number.)

The remote control and main unit are using different codes. Change the code on the remote control. (⇒ 84)

GUIDE

TV Guide data is being downloaded.

HARD ERR

If there is no change after switching the unit to standby mode and turning it on, consult the dealer.

NoREAD

- The disc is dirty. (⇒ 9) The unit cannot play.
- The lens cleaner has finished cleaning.
Press [▲ OPEN/CLOSE] on the main unit to eject the disc.

PLEASE WAIT

- Displayed when the unit is started and is switched to standby mode.
- There was a power failure or the AC plug was disconnected while the unit was on. The unit is carrying out its recovery process. Wait until the message disappears.

PROG FULL

There are already 32 timer programmes. Delete unnecessary timer programmes. (⇒ 32)

REMOVE

The USB device is drawing too much power. Remove the USB device.

Troubleshooting guide

START

Update of the software (firmware) is started.
You cannot operate the unit until the update is complete. (⇒ 82)

SW-DL

Software (firmware) is downloading.
Download will stop when the unit is turned on, or the timer recording starts. (⇒ 82)

UNSUPPORT

The media is not supported.

UPD □/□

("□" stands for a number.)

The software (firmware) is being updated.
You cannot operate the unit until the update is complete. (⇒ 82)

U59

The unit is hot.
The unit switches to standby for safety reasons.
Wait for about 30 minutes until the message disappears.
Do not block the cooling fan on the rear of the unit.

U61

(When a disc is not inserted) A malfunction has occurred. The unit is trying to restore to the normal operation. Once the message disappears you can use the unit again.
If it remains displayed, consult the dealer.

U76

HDMI cannot be output because it is connected to a model that does not support copyright protection.

U77

Due to the current disc not having authorised copyright information, video output is not performed.

U88

(When a disc is inserted) There was something unusual detected with the disc. The unit is trying to restore to the normal operation. Once the message disappears you can use the unit again. If it remains displayed, consult the dealer.

U99

The unit fails to operate properly. Press [⏻/I] on the main unit to switch the unit to standby mode. Now press [⏻/I] on the main unit again to turn the unit on.

X HOLD

The HOLD function is activated. (⇒ 83)

H□□ or F□□

("□" stands for a number.)

There is something unusual. (The service number displayed after H and F depends on the unit's condition.)

Reset the unit as follows:

- 1 Disconnect the plug from the household mains socket, wait a few seconds, then reconnect it.
- 2 Press [⏻/I] to turn the power on. (The unit may be fixed.)

Request service from the dealer. Inform the dealer of the service number when requesting service.

When you experience problems with Easy Network Setting

If there is any problem, the following message is displayed on the screen.

Wireless Settings

Display	Check the following
A conflict with other devices occurred.	<ul style="list-style-type: none"> • Please wait a few moments, and then try again.
A time out error occurred.	<ul style="list-style-type: none"> • Setting of the Wireless router for MAC Address etc. • The signal may be weak. • The SSID and the encryption key of the Wireless router.
An authentication error or a time out error occurred.	<ul style="list-style-type: none"> • Please wait a few moments, and then try again.
A device error occurred.	<ul style="list-style-type: none"> • If the problem is not solved, consult your dealer.

Troubleshooting guide

Easy Network Setting (Home Network Connection Check)

Display	Check the following
1. LAN cable connection or Wireless setting: "Fail" 2. IP address setting: "Fail" 3. Connection to gateway: "Fail"	<ul style="list-style-type: none"> • Connection of the LAN cables (⇒ 17) • Settings of the hub and router
1. LAN cable connection or Wireless setting: "Pass" 2. IP address setting: "Fail" 3. Connection to gateway: "Fail"	<ul style="list-style-type: none"> • Connection and settings of the hub and router • Settings of "IP Address / DNS Settings" (⇒ 68, 78)
1. LAN cable connection or Wireless setting: "Pass" 2. IP address setting: "Pass" 3. Connection to gateway: "Fail"	
1. LAN cable connection or Wireless setting: "Pass" 2. IP address setting: "Home network available" 3. Connection to gateway: "Fail"	

Easy Network Setting (Internet Connection Test)

Display	Check the following
Cannot find the server. (B019)	<ul style="list-style-type: none"> • "Primary DNS" and "Secondary DNS" settings of "IP Address / DNS Settings" (⇒ 68, 78)
No connection could be made to the server. (B020)	<ul style="list-style-type: none"> • The server may be busy or the service may have been suspended. Please wait a few moments, and then try again. • Settings of "Proxy Server Settings" (⇒ 68, 78) and the router.

Specifications

Specifications are subject to change without notice.

■ General

Dimensions: 430 mm (W)
59 mm (H)

(excluding the projecting parts)
238 mm (D)

(including the projecting parts)
249 mm (D)

Mass: Approx. 3.0 kg

Power supply: AC 220 to 240 V, 50 Hz

Power consumption: Approx. 28 W

“Power Save in Standby” is activated and

“RF OUT (Aerial Signal)” is set to “Off”

Approx. 0.2 W

“Power Save in Standby” is not activated

Approx. 4 W

Operating temperature: 5 °C to 40 °C

Operating humidity range: 10 % to 80 % RH
(no condensation)

■ TV system

Tuner System: DVB-T

Country: Australia

Channel Coverage: VHF 6~12

UHF 27~69

■ Recording system

Video: MPEG-2,
MPEG-4 AVC/H.264

Audio: Dolby Digital
(DR mode: Max 5.1ch (DVB-T))

HE-AAC (DR mode: 2ch (DVB-T))

MPEG (DR mode: 2ch)

■ Video

Video system: PAL/NTSC

Analog video output (pin jack): 1 pc.

Output level: 1 V_{p-p} (75 Ω)

■ Audio

Analog audio L/R out (pin jack): 1 pc.

Output level: Full scale 2.0 V_{rms} at 1 kHz (< 1 kΩ)

Digital audio out (optical): 1 pc.

Output format: PCM, Dolby Digital, DTS, MPEG

■ HDMI terminal

HDMI output (19 pin type A): 1 pc.

Output format: PCM, Dolby Digital, DTS, MPEG,
Dolby Digital Plus, Dolby TrueHD,

DTS-HD Master Audio,

DTS-HD High Resolution Audio

• This unit supports “HDAVI Control 5”

function.

■ Internal HDD capacity

500 GB

■ Other terminals

USB Port (Type A): 2 pcs.

SD Card Slot: 1 pc.

LAN (Ethernet) Port: 1 pc.

10BASE-T/100BASE-TX

■ Wireless LAN

Standard compliance: IEEE802.11b/g/n

Frequency range: 2.4 GHz band

Security*: WPA™/WPA2™

(Encryption type: TKIP/AES,

Authentication type: PSK)

WEP (64 bit/128 bit)

* This unit supports WPA and WPA2 encryption.

Specifications

■ LASER specification

Class 1 LASER Product

Wave length:

405 nm (BDs)
660 nm (DVDs)
790 nm (CDs)

Laser power:

No hazardous radiation is emitted with
the safety protection

■ Region code

DVD: #4
BD: Region B

■ Playable discs

BD-Video (Blu-ray 3D, BD-Live)

BD-ROM Version 2.4

BD-RE: Ver. 2.1, JPEG, MPO

BD-RE DL: Ver. 2.1, JPEG, MPO

BD-R: Ver. 1.3, LTH type Ver. 1.3,
DivX^{*1}, MKV^{*1}

BD-R DL: Ver. 1.3, DivX^{*1}, MKV^{*1}

DVD-R: DVD-Video format,
AVCHD format, JPEG^{*2}, MPO^{*2}, MP3^{*2},
DivX^{*2,3}, MKV^{*2,3}

DVD-R DL: DVD-Video format,
AVCHD format, JPEG^{*2}, MPO^{*2}, MP3^{*2},
DivX^{*2,3}, MKV^{*2,3}

DVD-RW: DVD-Video format,
DVD Video Recording format,
AVCHD format

+R: Video, AVCHD format

+R DL: Video, AVCHD format

+RW: Video, AVCHD format

DVD-Video: DVD-Video format

CD-Audio: CD-DA

CD-R/CD-RW: CD-DA, JPEG^{*2}, MPO^{*2}, MP3^{*2},
DivX^{*2}, MKV^{*2}

^{*1} UDF2.5

^{*2} ISO9660 level 1 or 2 (except for extended
formats), Joliet

This unit is compatible with multi-session.

This unit is not compatible with packet
writing.

^{*3} UDF1.02 without ISO9660, UDF1.5 with
ISO9660

■ SD Card

Compatible media: SD Memory Card^{*1}

Format: FAT12, FAT16, FAT32, exFAT^{*2}

Data that can be played: JPEG, MPO,
AVCHD format, MPEG-2, MP4

^{*1} Includes SDHC/SDXC cards.

Includes miniSD[™] cards (need a miniSD[™]
adaptor).

Includes microSD[™]/microSDHC[™]/
microSDXC[™] cards (need a microSD[™]
adaptor).

^{*2} SDXC only

■ USB device

USB standard: USB 2.0 High Speed

Format: FAT12, FAT16, FAT32

Data that can be played: MP3, JPEG, MPO,
DivX, MKV, MP4, MPEG-2

Audio information

The audio output differs depending on which
terminals are connected to the amplifier/receiver,
and the setting on this unit. (⇒ 75, Digital Audio
Output)

- The number of channels listed is the maximum
possible number of output channels when
connected to amplifier/receiver compatible with
the respective audio format.

Terminal	Digital Audio Output	
	Bitstream	PCM
HDMI AV OUT	Output using original audio ^{*1}	BD-Video: 7.1ch PCM ^{*1,2} DVD-Video: 5.1ch PCM
DIGITAL AUDIO OUT	Dolby Digital/ DTS Digital Surround	Down-mixed 2ch PCM

^{*1} When "BD-Video Secondary Audio" is set to
"On", the audio will be output as Dolby Digital,
DTS Digital Surround or 5.1ch PCM.

^{*2} The audio output is amplified from 5.1ch or
6.1ch to 7.1ch depending on the DTS, Inc.
specifications.

About recorded titles

■ Recording quality and approximate recording times

Depending on the content being recorded, the recording time may become shorter than indicated.

HD quality	69 hours
SD quality	131 hours

- Recording time may vary depending on the bit rate of broadcasting:

- High Definition (HD) quality: estimated bit rate is 15 Mbps
- Standard Definition (SD) quality: estimated bit rate is 8 Mbps

- Regarding recording time remaining:

Remaining time is calculated with a bit rate of 8 Mbps. But the bit rate differs depending on the broadcast, so the displayed remaining time might be different from the actual remaining time.

■ Maximum number of titles that can be recorded

999 titles

(When continuously recording for long durations, titles are automatically divided every 8 hours.)

Information for the files other than recorded programmes

■ JPEG/MPO

Playable media: HDD, BD-RE (SL/DL), DVD-R, DVD-R DL, CD-R, CD-RW, SD Card, USB device

Compatible pixels:

Between 34×34 and 8192×8192 pixels
(Sub sampling is 4:2:2 or 4:2:0)

Files: JPEG conforming DCF
(Design rule for Camera File system)
MPO conforming MPF
(Multi Picture Format)

Maximum numbers of folders and files:

Media	Maximum folders	Maximum files
HDD	–	20000
BD-RE	500	10000
DVD-R	500	10000
CD-R, CD-RW	500	10000
SD Card	500	10000
USB device	500	10000

- This unit is not compatible with MOTION JPEG or PROGRESSIVE JPEG.

■ MP3

Playable media: HDD, DVD-R, DVD-R DL, CD-R, CD-RW, USB device

Compression rate: 32 kbps to 320 kbps

Sampling rate: 16 kHz, 22.05 kHz, 24 kHz, 32 kHz, 44.1 kHz, 48 kHz

Maximum numbers of folders and files:

Media	Maximum folders	Maximum files
HDD	–	40000
DVD-R	300	3000
CD-R, CD-RW	300	3000
USB device	300	3000

Specifications

■ DivX

Playable media: BD-R (SL/DL), DVD-R, DVD-R DL, CD-R, CD-RW, USB device

Official DivX Certified® product
DivX Certified to play DivX video up to HD 1080p, including premium content.
GMC (Global Motion Compensation) is not supported.

Maximum number of folders: 300 folders
(including the root folder)
Maximum number of files: 200 files

• Support version

Picture resolution

Up to 1920×1080 pixels

Video

- Number of stream: Up to 1
- Codec: DIV3, DIV4, DIVX, DV50, DIV6
- FPS (Frame Per Second): Up to 60 fps

Audio

- Number of stream: Up to 8
- Format: MP3, MPEG, Dolby Digital
- Multi channel: Dolby Digital is possible. MPEG multi is 2 ch conversion.
- DVD-R and DVD-R DL must conform to UDF 1.02 without ISO9660 and UDF 1.5 with ISO9660.

■ MKV

Playable media: BD-R (SL/DL), DVD-R, DVD-R DL, CD-R, CD-RW, USB device

MPEG-4 AVC (H.264) profile is up to High Profile, Level 4.

AAC-LC, MP3, Dolby Digital audio, DTS, PCM, Vorbis and FLAC can be decoded.

Maximum number of folders: 300 folders
(including the root folder)
Maximum number of files: 200 files

■ SD-Video (Standard Definition)

Playable media: SD Card*¹, USB device
Codec: MPEG-2
File Format:

SD-Video format*²
used on Standard Definition Camera
(Panasonic and some other's)

*¹ Video Recording transfer is possible from SD card to HDD.

After Video Recording transfer to HDD is completed, the playback becomes possible.



*² SD-Video Entertainment Video Profile

■ HD-Video (High Definition)

Playable media: SD Card, USB device*
Codec: MPEG-4 AVC/H.264
File Format: AVCHD format conforming

* Video Recording conversion and transfer is possible from USB device to HDD.
After Video Recording conversion and transfer to HDD is completed, the playback becomes possible.

Licenses

<p>"AVCHD", "AVCHD 3D", "AVCHD Progressive" and "AVCHD 3D/Progressive" are trademarks of Panasonic Corporation and Sony Corporation.</p>	
<p>Copyright 2004-2010 Verance Corporation. Cinavia™ is a Verance Corporation trademark. Protected by U.S. Patent 7,369,677 and worldwide patents issued and pending under license from Verance Corporation. All rights reserved.</p>	
<p>DLNA, the DLNA Logo and DLNA CERTIFIED are trademarks, service marks, or certification marks of the Digital Living Network Alliance.</p>	
<p>DVB and the DVB logos are trademarks of the DVB Project.</p>	
<p>Manufactured under license from Dolby Laboratories. Dolby and the double-D symbol are trademarks of Dolby Laboratories.</p>	
<p>Manufactured under license under U.S. Patent Nos: 5,956,674; 5,974,380; 6,226,616; 6,487,535; 7,392,195; 7,272,567; 7,333,929; 7,212,872 & other U.S. and worldwide patents issued & pending. DTS-HD, the Symbol, & DTS-HD and the Symbol together are registered trademarks & DTS-HD Master Audio Essential is a trademark of DTS, Inc. Product includes software. © DTS, Inc. All Rights Reserved.</p>	
<p>"DVD Logo" is a trademark of DVD Format/Logo Licensing Corporation.</p>	
<p>MPEG Layer-3 audio coding technology licensed from Fraunhofer IIS and Thomson.</p>	
<p>This product is licensed under the AVC patent portfolio license and VC-1 patent portfolio license for the personal and non-commercial use of a consumer to (i) encode video in compliance with the AVC Standard and VC-1 Standard ("AVC/VC-1 Video") and/or (ii) decode AVC/VC-1 Video that was encoded by a consumer engaged in a personal and non-commercial activity and/or was obtained from a video provider licensed to provide AVC/VC-1 Video. No license is granted or shall be implied for any other use. Additional information may be obtained from MPEG LA, LLC. See http://www.mpegla.com.</p>	
<p>This item incorporates copy protection technology that is protected by U.S. patents and other intellectual property rights of Rovi Corporation. Reverse engineering and disassembly are prohibited.</p>	
<p>SDXC Logo is a trademark of SD-3C, LLC.</p>	
<p>Skype, associated trade marks and logos and the "S" logo are trade marks of Skype Limited.</p>	
<p>VIERA Connect is a trademark of Panasonic Corporation.</p>	
<p>The Wi-Fi CERTIFIED Logo is a certification mark of the Wi-Fi Alliance. The Wi-Fi Protected Setup Mark is a mark of the Wi-Fi Alliance.</p>	
<p>"Wi-Fi", "Wi-Fi Protected Setup", "WPA" and "WPA2" are marks or registered marks of the Wi-Fi Alliance.</p>	
<p>HDAVI Control™ is a trademark of Panasonic Corporation.</p>	
<p>HDMI, the HDMI Logo, and High-Definition Multimedia Interface are trademarks or registered trademarks of HDMI Licensing LLC in the United States and other countries.</p>	
<p>Java is a registered trademark of Oracle and/or its affiliates.</p>	
<p>Windows is a trademark or a registered trademark of Microsoft Corporation in the United States and other countries.</p>	

Licenses

DivX®, DivX Certified® and associated logos are trademarks of Rovi Corporation or its subsidiaries and are used under license.

ABOUT DIVX VIDEO:

DivX® is a digital video format created by DivX, LLC, a subsidiary of Rovi Corporation. This is an official DivX Certified® device that plays DivX video. Visit divx.com for more information and software tools to convert your files into DivX videos.

ABOUT DIVX VIDEO-ON-DEMAND:

This DivX Certified® device must be registered in order to play purchased DivX Video-on-Demand (VOD) movies. To obtain your registration code, locate the DivX VOD section in your device setup menu. Go to vod.divx.com for more information on how to complete your registration.

This product incorporates the following software or technology:

- (1) the software developed independently by or for Panasonic Corporation,
- (2) the software owned by third party and licensed to Panasonic Corporation,
- (3) the software developed by the Independent JPEG Group,
- (4) the software developed by the Freetype Project,
- (5) the software licensed under the GNU LESSER General Public License (LGPL) and/or,
- (6) open sourced software other than the software licensed under the LGPL,
- (7) Windows Media digital right management technology (WM-DRM) licensed by Microsoft Corporation or its affiliates.

For the software categorized as (5), please refer to the terms and conditions of LGPL, as the case may be at

<http://www.gnu.org/licenses/old-licenses/lgpl-2.1.html>

In addition, the software categorized as (5) are copyrighted by several individuals. Please refer to the copyright notice of those individuals at

<http://www.am-linux.jp/dl/FCRCP11/>

The LGPL software is distributed in the hope that it will be useful, but WITHOUT ANY WARRANTY, without even the implied warranty of MERCHANTABILITY or FITNESS FOR A PARTICULAR PURPOSE.

At least three (3) years from delivery of products, Panasonic will give to any third party who contacts us at the contact information provided below, for a charge no more than our cost of physically performing source code distribution, a complete machine-readable copy of the corresponding source code covered under LGPL.

Contact Information

cdrequest@am-linux.jp

Source code covered under LGPL is also freely available to you and any other member of the public via our website below.

<http://www.am-linux.jp/dl/FCRCP11/>

For the software categorized as (5) and (6), please refer to the applicable license terms included in the "Software Licence" menu on product.

Further, for WM-DRM categorized as (7), please be aware of the following.

(a) This product is protected by certain intellectual property rights of Microsoft.

Use or distribution of this technology outside of this product is prohibited without a license from Microsoft or an authorized Microsoft subsidiary.

(b) Content providers are using the digital rights management technology for Windows Media contained in this device ("WM-DRM") to protect the integrity of their content ("Secure Content") so that their intellectual property, including copyright, in such content is not misappropriated. This device uses WM-DRM software to play Secure Content ("WM-DRM Software"). If the security of the WM-DRM Software in this device has been compromised, owners of Secure Content ("Secure Content Owners") may request that Microsoft revoke the WM-DRM Software's right to acquire new licenses to copy, display and/or play Secure Content.

Revocation does not alter the WM-DRM Software's ability to play unprotected content. A list of revoked WM-DRM Software is sent to your device whenever you download a license for Secure Content from the Internet or from a PC. Microsoft may, in conjunction with such license, also download revocation lists onto your device on behalf of Secure Content Owners.

Vorbis, FLAC, WPA Supplicant

The software licenses are displayed when "Software Licence" in the Setup menu is selected. (⇒ 80)

Limited Warranty

Panasonic Warranty

- The product is warranted for 12 months from the date of purchase. Subject to the conditions of this warranty Panasonic or its Authorised Service Centre will perform necessary service on the product without charge for parts or labour, if in the opinion of Panasonic, the product is found to be faulty within the warranty period.
- This warranty only applies to Panasonic products purchased in Australia and sold by Panasonic Australia or its Authorised Distributors or Dealers and only where the products are used and serviced within Australia or its territories. Warranty cover only applies to service carried out by a Panasonic Authorised Service Centre and only if valid proof of purchase is presented when warranty service is requested.
- This warranty only applies if the product has been installed and used in accordance with the manufacturer's recommendations (as noted in the operating instructions) under normal use and reasonable care (in the opinion of Panasonic). The warranty covers normal domestic use only and does not cover damage, malfunction or failure resulting from use of incorrect voltages, incorrect installation, accident, misuse, neglect, build-up of dirt or dust, abuse, maladjustment of customer controls, mains supply problems, thunderstorm activity, infestation by insects or vermin, tampering or repair by unauthorised persons (including unauthorised alterations), introduction of sand, humidity or liquids, commercial use such as hotel, office, restaurant, or other business or rental use of the product, exposure to abnormally corrosive conditions or any foreign object or matter having entered the product.
- This warranty does not cover the following items unless the fault or defect existed at the time of purchase:

(a) Cabinet Part(s)	(e) DVD, Blu-ray or Recordable Discs
(b) Video or Audio Tapes	(f) Video / Audio Heads from wear and tear in normal use
(c) SD cards or USB devices	(g) Information stored on Hard Disk Drive, USB stick or SD card
(d) User replaceable Batteries	(h) DTV reception issues caused by TV Aerial / Cabling / Wall socket(s)

 etc
- Some products may be supplied with Ethernet connection hardware. The warranty is limited on such products and will not cover
 - Internet and or DLNA connection / setup related problems
 - Access fees and or charges incurred for internet connection
 - The use of incompatible software or software not specifically stipulated in the product operations manual; and
 - Any indirect or consequential costs associated with the incorrect use or misuse of the hardware, its connection to the internet or any other device.
- To claim warranty service, when required, you should:
 - Telephone Panasonic's Customer Care Centre on 132600 or visit our website referred to below and use the Service Centre Locator for the name/address of the nearest Authorised Service Centre.
 - Send or take the product to a Panasonic Authorised Service Centre together with your proof of purchase receipt as a proof of purchase date. Please note that freight and insurance to and / or from your nearest Authorised Service Centre must be arranged by you.
 - Note that home or pick-up/delivery service is available for the following products in the major metropolitan areas of Australia or the normal operating areas of the nearest Authorised Service Centres:
 - Plasma/LCD televisions / displays (screen size greater than 103 cm)
- The warranties hereby conferred do not extend to, and exclude, any costs associated with the installation, de-installation or re-installation of a product, including costs related to the mounting, de-mounting or remounting of any screen, (and any other ancillary activities), delivery, handling, freighting, transportation or insurance of the product or any part thereof or replacement of and do not extend to, and exclude, any damage or loss occurring by reason of, during, associated with, or related to such installation, de-installation, re-installation or transit.

Panasonic Authorised Service Centres are located in major metropolitan areas and most regional centres of Australia, however, coverage will vary dependant on product. For advice on exact Authorised Service Centre locations for your product, please telephone our Customer Care Centre on 132600 or visit our website and use the Service Centre Locator.

In addition to your rights under this warranty, Panasonic products come with consumer guarantees that cannot be excluded under the Australian Consumer Law. If there is a major failure with the product, you can reject the product and elect to have a refund or to have the product replaced or if you wish you may elect to keep the goods and be compensated for the drop in value of the goods. You are also entitled to have the product repaired or replaced if the product fails to be of acceptable quality and the failure does not amount to a major failure.

If there is a major failure in regard to the product which cannot be remedied then you must notify us within a reasonable period by contacting the Panasonic Customer Care Centre. If the failure in the product is not a major failure then Panasonic may choose to repair or replace the product and will do so in a reasonable period of time from receiving notice from you.

**THIS WARRANTY CARD AND THE PURCHASE DOCKET (OR SIMILAR PROOF OF PURCHASE)
SHOULD BE RETAINED BY THE CUSTOMER AT ALL TIMES**

If you require assistance regarding warranty conditions or any other enquiries, please visit the **Panasonic Australia** website **www.panasonic.com.au** or contact by phone on **132 600**
If phoning in, please ensure you have your operating instructions available.

Panasonic Australia Pty. Limited

ACN 001 592 187 ABN 83 001 592 187

1 Innovation Road, Macquarie Park NSW 2113

Index

- A**
- Aspect** 76, 83
 - Audio**
 - Broadcasts 25
 - Digital Audio 94
 - Playback 40
 - Auto Setup** 19, 71
 - AVCHD**
 - Copy 56
 - Playback 33, 36
- B**
- BD-Live** 37
 - BD-Video**
 - BD-Live 37, 73
 - Playback 36
 - 3D 40
 - BD-Video Parental Control** 73
- C**
- Channel information** 24
 - Channel List** 23
 - Edit 71
 - Chapter** 35, 39, 45
 - Child Lock (Parental Rating)** 71
 - Clock** 80
 - Connection**
 - Amplifier/receiver 15
 - AUDIO OUT terminal 16
 - Audio/Video terminal 14
 - Basic connections 13
 - HDMI cable 13, 15
 - Network 17
 - Copy (Music)** 52
 - Copy (Photo)** 51
 - Copy (Video)** 46
 - HD Video (AVCHD) 56
 - SD Video (MPEG2) 57
- D**
- Delete**
 - Delete BD-Video data 37
 - Music 55
 - Photo 50
 - Video 42
 - Delete all photos**
 - HDD 73
 - Delete all titles**
 - HDD 73
 - USB HDD 74
 - Delete BD-Video data** 37
 - DIRECT NAVIGATOR**
 - Music 53
 - Photo 48
 - Video 33
 - Disc**
 - Media information 6
 - DivX**
 - Playback 36
 - DLNA**
 - Client 59
 - Media Renderer 60
 - Server 58, 79
 - DVD-Video**
 - Playback 36
 - DVD-Video Parental Control** 73
- E**
- Easy Network Setting** 20, 78
 - Easy setting** 19
 - Edit (Music)** 55
 - Edit (Photo)** 50
 - Edit (Video)** 43
 - Chapter 39, 45
 - Delete 42, 43
 - Protection 43
 - Entering text** 83
- F**
- Favourites** 70
 - Format**
 - HDD 73
 - SD Card 61
 - USB HDD 74
 - FUNCTION MENU** 22

Index

H

HD Video (AVCHD)	
Copy	56
Play	33, 36
HDAVI Control	64, 77
HDD	
Delete all photos	73
Delete all titles	73
Format	73
Media information	6
HDMI cable	13
HOLD function	83

J

JPEG	48
-------------	----

L

Language code list	81
---------------------------	----

M

Manual Tuning	71
----------------------	----

Media

Disc	6
HDD	6
SD Card	6, 9
USB HDD	6
USB memories	6, 9

Media Renderer	60
-----------------------	----

Menu screen	36
--------------------	----

MKV

Playback	36
----------	----

MPEG2	57
--------------	----

MPO	48
------------	----

MP3	52
------------	----

Music

Copy	52
Delete	55
Edit	55
Playback	52

N**Network**

BD-Live	37
Connection	17
DLNA (Client)	59
DLNA (Server)	58, 79
Setting	78
Software (Firmware) Update	82
VIERA Connect	65

P

PAUSE LIVE TV	25
----------------------	----

Photo

Copy	51
Delete	50
Edit	50
Playback	48
Protection	50
Slideshow	48, 54

PIN	70
------------	----

Playback menu	66
----------------------	----

Playback (Music)

Audio CD	52
MP3	52
Recorded on HDD	53

Playback (Photo)	48
-------------------------	----

Slideshow	48, 54
-----------	--------

Playback (Video)

AVCHD	33, 36
BD-Video	36
BD-Video Parental Control	73
Changing audio	40
Chapter	35
DivX	36
DVD-Video	36
DVD-Video Parental Control	73
MKV	36
Playlist created on other equipment	36
Recorded video contents	33
Status message	38
Subtitles	40
3D	40

Power Save in Standby	79
------------------------------	----

Protection

HOLD function	83
Photo	50
Video	43

R

Recording	27
------------------	----

Recording quality	95
Recording time	95
Timer recording	29

Recording quality	95
--------------------------	----

Remote control	11
-----------------------	----

HOLD function	83
Manufacturer and Code No.	18
Remote control code	80
TV operation	18

Reset	81, 87, 89
--------------	------------

REWIND LIVE TV	25, 73
-----------------------	--------

S	
SD Card	
Format	61
Media information	6, 9
miniSD / microSD	9
SD Video (MPEG2)	
Copy	57
Setting	
Auto Setup	19, 71
Easy Network Setting	20, 78
Easy setting	19
Setup menu	68
Connection	76
Digital TV Tuning	70
Display	76
HDD / Disc / USB HDD	72
Network	78
Others	79
Picture	74
Sound	75
Skype™	65
Slideshow	48, 54
Software (Firmware) Update	82
Subtitles	
Broadcasts	25
Playback	40
T	
Teletext	25, 76
Timer recording	29
Auto Renewal Recording	30
Manually programming timer recording	30
Tuning	
Channel List	71
Manual Tuning	71
Parental Rating	71
Signal condition	72
TV Guide	
Operation	24
Timer recording	29
TV System	76
U	
Unit's display	
Messages	89
USB HDD	
Cancellation of all USB HDD Registrations	74
Delete all titles	74
Disconnection	62, 74
Format	74
Media information	6
Registration	62, 74
USB memories	
Media information	6, 9
V	
Video	
Copy	46
Delete	42
DIRECT NAVIGATOR	33
Edit	43
Playback	33, 36
Protection	43
Recording	27
VIERA Connect	65
VIERA Link	64, 77
3D	40

Information on Disposal in other Countries outside the European Union



This symbol is only valid in the European Union.

If you wish to discard this product, please contact your local authorities or dealer and ask for the correct method of disposal.

The recording and playback of content on this or any other device may require permission from the owner of the copyright or other such rights in that content. Panasonic has no authority to and does not grant you that permission and explicitly disclaims any right, ability or intention to obtain such permission on your behalf. It is your responsibility to ensure that your use of this or any other device complies with applicable copyright legislation in your country. Please refer to that legislation for more information on the relevant laws and regulations involved or contact the owner of the rights in the content you wish to record or playback.

Panasonic Corporation
Web Site: <http://panasonic.net>

(En)

VQT4C70

F0212MD0