

CONTENTS		Page
Warranty	Inside of front cover	
Warning		1
Installation Instructions		3
Oven Diagram		4
Operation of Control Panel		5
Touch Control Panel Layout		5
Display Information		5
Important Instructions		6
Read Carefully Before Cooking in SuperSteam Convection & Steam		6
SuperSteam Convection & Steam in Automatic and Manual Cooking		7
Drain Water Function		8
Descale Function		8
Before Operating		9
Getting Started		9
Stop/Clear		9
Back		9
Clean the Oven Before First Use		9
Automatic Cooking		10
SuperSteam Convection		10
Steam		12
Microwave		13
Manual Cooking		14
Manual Cooking Chart		14
SuperSteam Convection		15
Convection		17
Steam		18
Microwave		20
Other Convenient Features		21
Automatic Cooking Time Adjustment		21
Extending Cooking Time at the End of Cooking		21
Temperature Adjustment		21
End of Cooking Reminder		21
Multiple Sequence Cooking		22
Info		23
Cleaning and Care		24
Steam Clean		24
Troubleshooting Chart		26
Service Call Check		29
Specifications		29
Cooking Guides		30
About Your Oven		30
About Cooking Options		30
About Utensils and Coverings		31
SuperSteam Convection and Steam Cooking Advice		32
Microwave Cooking Advice		34
Automatic Cooking Chart		36
SuperSteam Convection Menu Guide		36
Steam Menu Guide		41

SUPERSTEAM™

SHARP

WARRANTY

Consumer Electronic Products

Congratulations on Your Purchase!

This Sharp product is warranted against faults in materials and manufacture for a period of twelve(12) months from the date of original purchase.

If service is required during the warranty period, please contact your nearest Sharp Approved Service Centre. These repairs would be carried out at no charge to the owner, subject to the conditions specified herein.

The owner is responsible for any transportation and insurance costs if the product has to be returned for repair.

This warranty does not extend to accessories or defects or injuries caused by or resulting from causes not attributable to faulty parts or the manufacture of the product, including but not limited to, defect or injury caused by or resulting from misuse, abuse, neglect, accidental damage, improper voltage, liquid spillage, vermin infestation, software, or any alterations made to the product which are not authorised by Sharp.

Please retain your sales documentation, as this should be produced to validate a warranty claim.

This warranty is in addition to and in no way limits, varies or excludes any express and implied rights and remedies under any relevant legislation in the country of sale.

IMPORTANT

DO NOT RETURN THIS DOCUMENT TO SHARP

For your reference, please enter the particulars of your purchase below and retain, with your purchase documentation.

Model No. _____

Serial No. _____

Date of Purchase _____

Retailer _____

SHARP
SHARP CORPORATION OF AUSTRALIA PTY. LIMITED
ABN 40 003 039 405
1 Huntingwood Drive
Huntingwood NSW 2148
SHARP CORPORATION OF NEW ZEALAND LIMITED
59 Hugo Johnston Drive
Penrose, Auckland

IMPORTANT NOTICE: This warranty applies only to products sold in Australia & New Zealand

SHARP

FOR LOCATION ENQUIRIES WITHIN

AUSTRALIA

REGARDING YOUR LOCAL

SHARP APPROVED SERVICE CENTRE

VISIT OUR WEBSITE AT

www.sharp.net.au

OR CALL SHARP CUSTOMER CARE

1300 135 022

(LOCAL CALL COST APPLY WITHIN AUSTRALIA)

SHARP CORPORATION OF AUSTRALIA PTY LTD

SHARP

FOR LOCATION ENQUIRIES WITHIN

NEW ZEALAND

REGARDING YOUR LOCAL

SHARP APPROVED SERVICE CENTRE

VISIT OUR WEBSITE AT

www.sharp.net.nz

CONTACT YOUR SELLING DEALER/RETAILER
OR CALL

SHARP CUSTOMER CARE

TELEPHONE: 09 573 0111

FACSIMILE: 09 573 0113

SHARP CORPORATION OF NEW ZEALAND LIMITED

WARNING

IMPORTANT SAFETY INSTRUCTIONS: READ CAREFULLY AND KEEP FOR FUTURE REFERENCE.

1. To reduce the risk of fire in the oven cavity:
 - a. No other liquid than room temperature water suitable for drinking (filtered) can be poured into the water tank.
 - b. The oven should not be left unattended during operation. High oven temperature or long cooking time may overheat foods resulting in a fire.
 - c. Do not overcook food.
 - d. Remove wire twist-ties from paper or plastic bags before placing bag in the oven.
 - e. Do not heat oil or fat for deep frying. The temperature of the oil cannot be controlled.
 - f. Look at the oven from time to time when food is heated in disposable containers made of plastic, paper or other combustible materials for signs of smoke or burning.
 - g. If materials inside the oven should ignite, or smoke is observed, keep oven door closed, turn oven off, and disconnect the power plug, or shut off power at the fuse or circuit breaker panel.
 - h. Do not use containers made of synthetic material for cooking. They could melt at high temperature.
 - i. Do not use plastic containers if the oven is still hot because they may melt. Plastic containers must not be used on SuperSteam Convection or Convection modes unless the container manufacturer claims it is suitable.
 - j. Do not store food or any other items inside the oven.
 - k. When alcoholic beverage are added when roasting or cooking cakes and sweets, there is a risk that vapours released by the alcohol may catch fire upon coming into contact with the electrical heating element. Attend the oven closely during cooking.
2. To reduce the risk of an explosion or delayed eruptive boiling when handling the container. Your oven is capable of heating food and beverages very quickly with microwave, therefore it is very important that you select the appropriate cooking time and power level for the type and quantity of food to be heated. If you are unsure of the cooking time and power level required, begin with low cooking times and power levels until the food is sufficiently heated evenly throughout.

Additionally:

 - a. Do not place sealed containers in the oven. Babies bottles fitted with a screw cap or teat are considered to be sealed containers.
 - b. Do not use excessive amount of time.
 - c. When boiling liquids in the oven, use a wide-mouthed container.
 - d. Stand at least for 20 seconds at the end of cooking to avoid delayed eruptive boiling of liquids.
 - e. Stir the liquid before and during cooking. Use extreme care when handling the container or inserting a spoon or other utensil into the container.
3. This oven is for home food preparation only and should only be used for heating, cooking and defrosting food and beverage.

It is not suitable for commercial, laboratory use, or heating therapeutic devices eg. Wheat bags.
4. Never operate the oven whilst any object is caught or jammed between the door and the oven.
5. Do not try to adjust or repair the oven by yourself. It is hazardous for anyone other than a qualified service technician trained by SHARP to carry out any service or repair operation. Especially those which involve the removal of a cover which gives protection against exposure to microwave energy are very hazardous.
6. Do not operate the oven if it is not working correctly or damaged until it has been repaired by a qualified service technician trained by SHARP. It is particularly important that the oven door closes properly and that there is no damage to:
(1) Door (warped), (2) Hinges and Latches (broken or loosened), (3) Door Seals, Sealing Surfaces and oven cavity (buckled or deformed), (4) Burn marks on the door seal faces.
7. Handle with care when removing items from the oven so that the utensil, your clothes or accessories do not touch the latches.
8. Never poke an object, particularly a metal object, through a grille or between the door and the oven while the oven is operating.
9. Never tamper with or deactivate the latches.
10. Always use oven gloves to prevent burns when handling utensils that are in contact with hot food. Enough heat from the food can transfer through utensils to cause skin burns.
11. Should the power supply cord become damaged, it must be replaced with a special cord supplied by a SERVICE CENTRE APPROVED BY SHARP. And it must be replaced by a qualified service technician trained by SHARP in order to avoid a hazard.
12. If the oven lamp fails please consult your dealer or a qualified service technician trained by SHARP.

13. Avoid steam burns by directing steam away from the face and hands. Slowly lift the furthest edge of a dish's cover including microwave plastic wrap etc., and carefully open popcorn and oven cooking bags away from the face.
14. Make sure that the power supply cord is undamaged, and that it does not run under the oven or over any hot surfaces or sharp edges.
15. Use care when opening door. To avoid burns from escaping heat and steam, let hot air or steam escape before removing or replacing food.
16. Do not place anything on the outer cabinet because the oven will become very hot during operation.
17. To avoid burns, always test the food and container temperature and stir before serving. Pay special attention to the temperature of food and drink given to babies, children and the elderly. Do not drink beverage or soup without checking the container's temperature. Take extra caution when handling the container because it becomes very hot.
18. Make sure the utensil does not touch the interior walls during cooking.
19. This appliance is not intended for use by persons (including children) with reduced physical, sensory or mental capabilities, or lack of experience and knowledge, unless they have been given supervision or instruction concerning use of the appliance by a person responsible for their safety.
20. Children should be supervised to ensure that they do not play with the appliance.
21. Accessible parts (e.g. oven door, oven cavity, dishes and accessories) may become hot during use. To avoid burns young children should be kept away. Always use thick oven gloves to prevent yourself from getting burnt.
22. When the appliance is operated in SuperSteam Convection, Convection or Steam, children should only use the oven under adult supervision due to the temperature generated.
23. Do not touch the oven door, outer cabinet, rear cabinet, oven cavity, air-vent openings, accessories and dishes because the escaping steam from the ventilation cover during operation becomes hot.
24. Do not touch around the oven lamps directly. This part will become hot when the oven lamp is on.
25. When the oven is in use, ventilate a room where the oven is installed. e.g. open a window or switch a kitchen ventilation fan on. Steam from the ventilation cover may wet nearby walls or furniture.
26. Do not operate the oven if the water tank cracks and water leaks. Please contact a SERVICE CENTRE APPROVED BY SHARP.
27. To prevent condensation which could corrode the appliance, do not leave cooked food in the oven for an extended period. Clean the oven at regular intervals and remove any food deposits in the oven or on the door.
28. Do not insert fingers or objects in the holes (the steam outlets or air-vent openings) as this may damage the oven and cause an electric shock or a hazard.
29. Do not place any things weighing more than 5 kg on the door to prevent that the oven may fall down or could damage the door and hinges. Do not cling onto the handle and do not hang heavy objects from it.
30. Do not touch the electric plug with wet hands and plug into the electric wall socket securely. When removing the plug from the socket always grip the plug, never pull the power supply cord as this may damage the power supply cord and the connections inside the plug.
31. Never move the oven in operating. If the oven needs to be moved, always drain all water inside the oven using DRAIN WATER function. After draining, empty the drip tray.
32. Do not water the door or control panel intentionally.
33. If the oven falls down or drops on the floor, do not use the oven. Unplug and contact a SERVICE CENTRE APPROVED BY SHARP.
34. Only allow children to use the oven, without supervision, when adequate instructions have been given so that the child is able to use the oven in a safe way and understands the hazards of improper use.

INSTALLATION INSTRUCTIONS

1. Remove all packing materials from the oven cavity, and the feature sticker from the outside of the door, if there is one. Check the unit for any damage, such as a misaligned door, damaged door seals around the door or dents inside the oven cavity or on the door. If there is any damage, please do not operate the oven until it has been checked by a SERVICE CENTRE APPROVED BY SHARP and repaired, if necessary.
2. Accessories provided
 - 1) Rack
 - 2) 2 Baking trays
 - 3) Steam tray
 - 4) Descaling guide
 - 5) Operation manual
 - 6) Cookbook
 - 7) Touch guide
 - 8) Test strip
3. Since the door may become hot during cooking, and in order to avoid its accidental touch, the oven should be placed at least 85 cm or more above floor. You should also keep children away from the door to prevent them burning themselves.
4. This oven is designed to be used on a countertop or in a cabinet. It should not be installed in any area where excessive heat and steam are generated, for example, next to a conventional oven unit. It should not be installed near combustible materials, for example, curtains. The oven should be installed so as not to block ventilation openings. A fire may occur if this appliance is covered or touching flammable material, including curtains, drapes, walls, etc. Allow a space of at least 10cm on the top, both sides and at the rear of the oven for adequate air circulation. When installing in a cabinet, the minimum inside dimension of the cabinet should be 723mm(W) x 500mm(H) x 560mm(D). Refer to Figure 1 below. This oven is not designed for built-in installation.

WARNING: Steam is ventilated from the top rear of the oven. Make sure the escaping steam does not wet electrical outlets/other electrical appliances.
5. If the window is close to the oven, keep more than 20 cm distance between the ventilation and the window. Window may be broken by the heat from the ventilation.

CAUTION: Steam ventilated from the oven may wet or dirty nearby furniture or wall. Keep sufficient space between the oven and the wall or furniture. Steam comes from the ventilation cover or door during cooking or after cooking. Condensation may form on the wall or furniture around the oven. Install the oven where it can be well ventilated.

To prevent from getting wet, we recommend to cover the wall or furniture with aluminium foil.
6. Do not connect other appliances to the same socket using an adaptor plug.
7. Neither the manufacturer nor the distributors can accept any liability for damage to the machine or personal injury for failure to observe the correct electrical connecting procedure. The A.C. voltage and frequency must be single phase 230-240V, 50Hz.
8. This appliance must be earthed.
9. Operate the oven from a general purpose domestic outlet. If a generator is used, do not operate the oven with non-sinusoidal outputs.

Figure 1

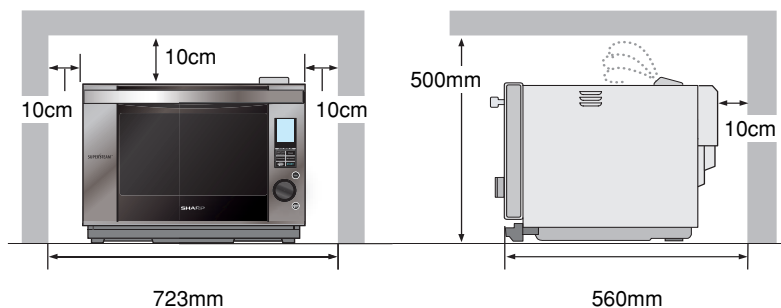

OVEN DIAGRAM

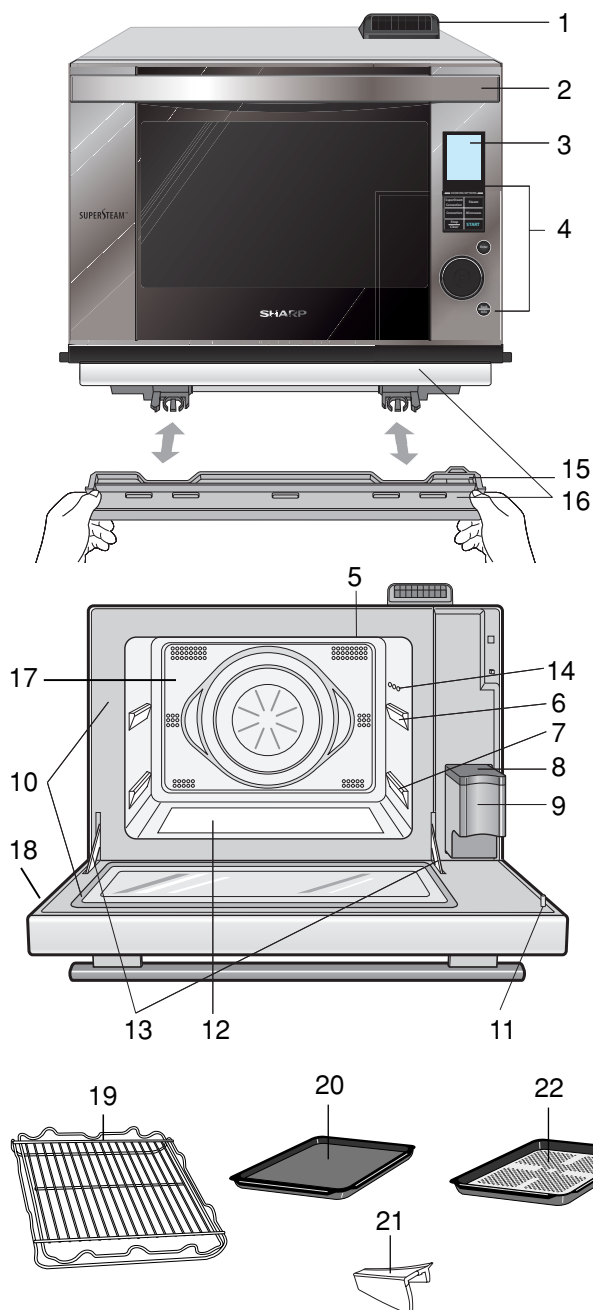

- 1** Ventilation openings
- 2** Door open handle
- 3** LCD display
- 4** Control panel
- 5** Oven lamp
- 6** Upper position
- 7** Lower position
- 8** Water tank lid (See page 6.)
- 9** Water tank (See page 6.)
- 10** Door seals and sealing surfaces
- 11** Latches
- 12** Ceramic oven floor
- 13** Door hinges
- 14** Steam outlets
- 15** Drip tray lid (See page 6.)
- 16** Drip tray (See page 6.)
- 17** Oven cavity
- 18** See through door

ACCESSORIES

- 19** Rack
For SuperSteam Convection, Convection and Steam.
Do not use when microwave cooking.
Always place on baking tray.
- 20** Baking tray x2
For SuperSteam Convection, Convection, Steam and Descale function. Do not use when microwave cooking.
- 21** Descaling guide (See page 8.)
- 22** Steam tray
For Steam. You can also use for SuperSteam Convection and Convection. Do not use when microwave cooking. Place on rack in baking tray.

WARNING:

The oven cavity, door, outer cabinet, accessories and dishes will become very hot, use thick dry oven gloves when removing food or accessories from the oven to prevent burns.

OPERATION OF CONTROL PANEL

The operation of the oven is controlled by pressing the appropriate pads arranged on the surface of the control panel. An entry signal tone should be heard each time you press the control panel to make a correct entry. In addition the oven will beep for approximately 2 seconds at the end of the cooking cycle, or 4 times when a cooking procedure is required.

Touch Control Panel Layout



1. SuperSteam Convection pad

Press to select SuperSteam Convection cooking. SuperSteam Convection has 2 options; "automatic cooking" and "manual cooking".

2. Convection pad

Press to select Manual Convection cooking. No automatic cooking mode for Convection.

3. Stop/Clear pad

Press to clear during programming. Press once to stop operation of oven during cooking; Press twice to cancel cooking programme.

4. Steam pad

Press to select Steam cooking. Steam has 2 options; "automatic cooking" and "manual cooking".

5. Microwave pad

Press to select Microwave cooking. Microwave has 3 options; "auto defrost", "sensor reheat" and "manual cooking"

6. START pad

Press to start oven after setting programmes.

7. Enter pad

Press to confirm your choice.

8. Knob

Turn to select desired option.

9. Back/Info pad



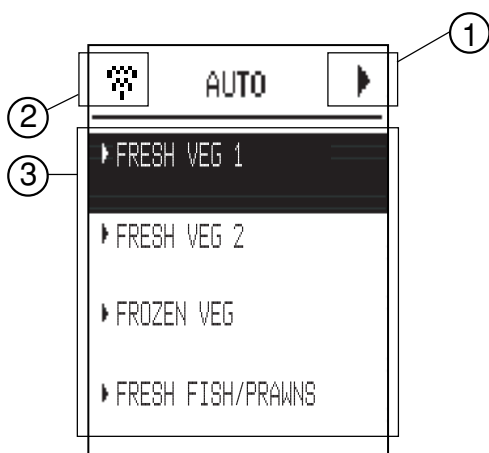

Press to go back to the previous page during programming before pressing **START**. Press to do maintenance to your oven, or customise it.

Display Information



①  Arrows indicate more than one page; when you see an arrow, you can turn the knob to move back and forth between pages. When there are no arrows, you can go back to the previous page by touching **Back/Info**.

② The illustration at the top of display indicates the selected cooking mode.

-  SuperSteam Convection was selected.
-  Steam was selected.
-  Microwave was selected.
-  Convection was selected.

③ Words will light in the display to indicate features and cooking instructions.

IMPORTANT INSTRUCTIONS

Read Carefully Before Cooking in SuperSteam Convection & Steam

WATER TANK

Fill the water tank with room temperature water suitable for drinking (filtered). Be sure to follow the directions below.

1. Pull the water tank toward you to remove.
2. Wash the water tank and lid for the first time. (Figure 1)
3. Fill the water tank with **room temperature water suitable for drinking (filtered) through the lid to the 2 mark (MAX mark) each time you begin to cook.** (Figure 2) Do not fill the water tank over the 2 mark (MAX mark).
4. Make sure the lid is closed firmly.
5. Install the water tank by pushing firmly. (Figure 3)
6. After cooking, empty the water tank and wash the water tank and the lid.

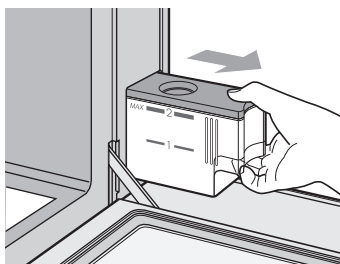

Figure 1

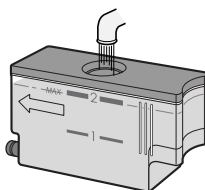

Figure 2

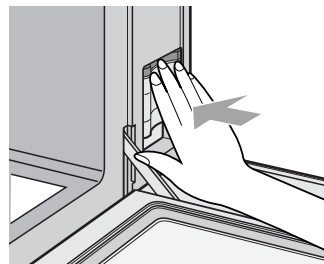

Figure 3

NOTES:

1. Do not use any other liquids such as distilled water, mineral water and etc.
2. An insufficient amount of water in the water tank may cause an undesired result.
3. We recommend that you empty the water tank every time after cooking. Do not leave the water tank filled with water in the oven over a day.
4. If any messages, such as "Fill water tank", are as shown in the display during cooking, refer to Troubleshooting Chart on page 26.
5. Do not drop or damage the water tank. Heat may cause the water tank to change shape. Do not use a damaged water tank. Contact a SERVICE CENTRE APPROVED BY SHARP.
6. There may be a few water drops when removing the water tank. Wipe the oven dry with a soft cloth.
7. Do not block the air holes on the lid of the water tank. It will cause trouble during cooking.
8. A small amount of water will drain into the drip tray when the water tank is removed. Empty after cooking.

DRIP TRAY

Be sure to cook with drip tray in position and follow the directions below.

The drip tray and the lid are packed with the oven. Place the drip tray and lid under the oven door as shown in Figure 4. This drip tray collects the condensation from the oven door.

To remove the drip tray: Pull the drip tray toward you with both hands.

* Make sure water is not dripping down before removing the drip tray.

To replace the drip tray: Place the drip tray onto the right and left hooks under the oven and push firmly as shown in Figure 4. Insert the drip tray horizontally when you attach it. Improper use may cause the damage to the hooks.

If "Replace drip tray" or "Empty drip tray and replace" is as shown in the display, remove and then replace the drip tray correctly.

Empty the drip tray after each time you cook. Empty, rinse thoroughly, dry and replace. Failure to empty may cause the drip tray to overflow. Cooking repeatedly without emptying the drip tray may cause it to overflow.

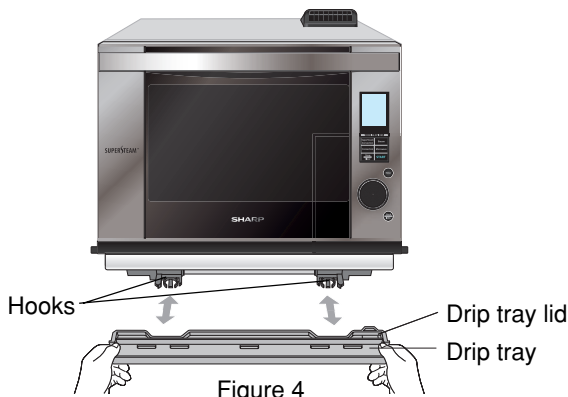

Figure 4

WARNINGS:

1. The oven will become very hot after cooking and draining water function.
2. Do not open the oven with your face close to the oven. Steam from the oven may cause burns.
3. Make sure that the oven has cooled before emptying the water tank and the drip tray and then wipe the oven cavity.
4. Do not touch the water directly as water in the drip tray may be hot.

IMPORTANT INSTRUCTIONS

SuperSteam Convection & Steam in Automatic and Manual Cooking

Before cooking

1. Make sure the water tank is filled with room temperature water suitable for drinking (filtered) and is installed. (See page 6.)
2. Make sure the empty drip tray is installed. (See page 6.)
3. Place food in the oven unless preheating is needed. (Refer to each chart to check if preheating is required in automatic operations.)

After Cooking

1. After the oven has cooled, remove and empty the water tank, wipe oven cavity. Wait a few minutes, then empty the drip tray.
2. Perform the Drain Water function at least once a day after using SuperSteam Convection or Steam mode.
3. Check that water is not dripping down before removing the drip tray, as a small amount of water drains into the drip tray when the water tank is removed.

Oven Door Opening

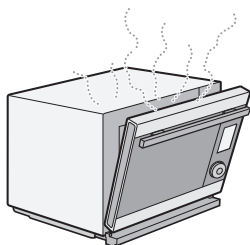

Figure 1

You can leave the oven door partly open to exhaust steam, to cool or dry the oven cavity temporarily after cooking. (See Figure 1)

WARNING: Do not open the oven with your face close to the oven. Steam from the oven may cause burns.

NOTE: Avoid opening and closing the door during cooking as the oven cavity temperature drops suddenly, which may affect the result.



IMPORTANT INSTRUCTIONS

Drain Water Function

Perform the Drain Water function at least once a day after using SuperSteam Convection or Steam mode. It takes up to 8 minutes.

Drain Water function is very useful to prevent scale build up and the use of stale water. It causes evaporation of the internal steam system.

PROCEDURE

- 1 Press **Back/Info**, turn the **Knob** to select **DRAIN WATER** and press **Enter**.
 
- 2 Make sure the water tank is removed and press **START**.
 
- 3 After the oven has cooled, wipe oven cavity. Wait a few minutes, then empty the drip tray.

NOTE:

The water tank must be removed before starting this procedure.

Descal Function

White or gray grains, also called scale, may form in the water circuit inside the oven during steam generation, which could cause the oven to malfunction.

When "DESCALING IS NECESSARY" is shown in the display, be sure to carry out Descal function immediately. It takes about 1 hour.

PROCEDURE

- 1 Press **Back/Info**, turn the **Knob** to select **DESCALE** and press **Enter**.
 
- 2 Pure citric acid, available at some pharmacies/chemists, or bottled 100% lemon juice with no pulp are used for descaling. Choose one and prepare the descaling solution.

To use pure citric acid, dissolve 1 tablespoon of pure citric acid crystals in 500ml of water in a non-porous container. Stir well and pour into the water tank.

To use 100% bottled lemon juice, check that there is absolutely no pulp in it. If there is pulp or you are not sure, strain through a fine strainer. Measure 70ml of the strained lemon juice and add it to 500ml of water. Stir well and pour into the water tank.

Place the water tank in the oven correctly and push firmly into place.

- 3 Place baking tray on upper level. Place descaling guide on the right side edge of baking tray as shown in Figure 1. Push down the right side edge of descaling guide to insert the projection between the wall and the baking tray as shown in Figure 2. Check that the edge of the descaling guide is below all steam outlets/screw heads as shown in Figure 3.

- 4 Do not place any food in the oven. Press **START** to begin descaling.
 

- 5 When the oven has stopped and is cool, remove water tank, empty, rinse and refill with room temperature water suitable for drinking (filtered). Replace water tank. Remove the descaling guide as shown in Figure 4. Remove baking tray, empty, rinse and dry. Follow step 3 to replace baking tray and descaling guide. Press **START**. Rinsing will start.
 

- 6 When rinsing has ended and the oven is cool, remove water tank and empty. Then remove descaling guide as shown in Figure 4. Remove baking tray and empty. Wipe oven cavity to dry. Wait a few minutes and then empty the drip tray.

WARNING:

The area around the steam outlets becomes hot. Pay extra attention to attach or remove descaling guide.

NOTE:

Oven light goes off after Enter is pressed at Step 1.

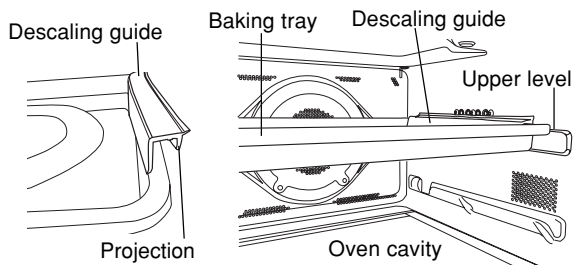

Figure 1

Figure 2

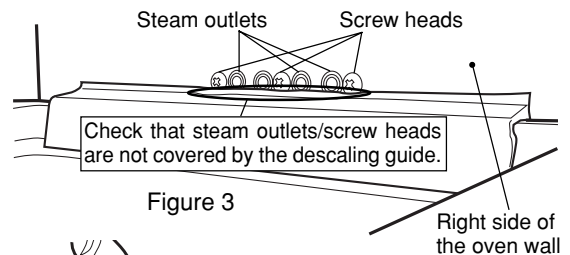

Figure 3



Figure 4
Removing descaling guide.

BEFORE OPERATING

- Before operating your Superheated Steam oven, make sure you read and understand this operation manual completely.
- Before the oven can be used, follow these procedures:
 1. Place the drip tray correctly. See page 6.
 2. See below for getting started.
 3. Follow directions on the right side of this page to clean the oven before first use.

Getting Started

Your oven has an Energy Save Mode. This facility saves electricity when the oven is not in use.

PROCEDURE

- 1** Plug the oven into a power point. Nothing will appear on the display at this time.
- 2** Open the door. The display will show ENERGY SAVE MODE.
- 3** Close the door. Now you are ready to use the oven.

CAUTION:

In Energy Save Mode, if you do not operate the oven for 3 minutes or more (i.e. after closing the door, or pressing the **Stop/Clear** pad, or at the end of cooking), you will not be able to operate the oven until you open and close the oven door.

NOTE:

When you set Child Lock or Demonstration Mode, Energy Save Mode will be cancelled temporary.

Stop/Clear

Press **Stop/Clear** if:

1. You make a mistake during programming.
2. To stop the oven temporarily during cooking.
3. To return to the home page ("ENERGY SAVE MODE" is displayed).
4. To cancel a programme during cooking, press twice.

Back

1. Press **Back/Info** if you want to go back to the previous page during programming before pressing **START**.
2. After pressing **START**, it is not possible to return to a previous page.





CLEAN THE OVEN BEFORE FIRST USE

The steam generator heats the water which is used for cooking. It should be cleaned before the first use to get rid of any odour in the oven cavity. Clean the oven with SuperSteam Convection Grill in manual operation for 20 minutes without preheat and food. You may notice some smoke and odour during this process. This is normal. The oven is not faulty.

PREPARATION

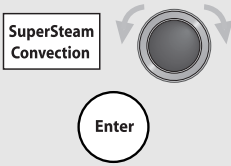
1. Ventilate the room.
2. Make sure the water tank is filled with room temperature water suitable for drinking (filtered) and is installed.
3. Make sure that the empty drip tray is installed.

PROCEDURE

- 1** Press **SuperSteam Convection**, turn the **Knob** to select **MANUAL** and press **Enter**.

- 2** Turn the **Knob** to select **SUPER STEAM GRILL** and press **Enter**.

- 3** Turn the **Knob** to select **WITHOUT PREHEAT** and press **Enter**.

- 4** Turn the **Knob** to enter cooking time (20 min.) and press **START**.

WARNINGS:

1. The oven door, outer cabinet and oven cavity will become hot.
2. Do not open the oven with your face close to the oven. Steam from the oven may cause burns.

AUTOMATIC COOKING

Automatic Operation is available with SuperSteam Convection, Steam and Microwave. Refer to each function for the details.

SuperSteam Convection

SuperSteam Convection has 4 options: Complete Meals, Grill, Roast and Bake.

Refer to the SuperSteam Convection Menu Guide for details on page 36-40.

COMPLETE MEALS

* Suppose you want to cook Complete Meals Salmon Steaks with Potato Bake with Standard time.

PROCEDURE

1 Press **SuperSteam Convection**, turn the **Knob** to select **AUTO** and press **Enter**.

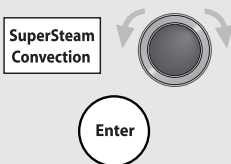

2 Turn the **Knob** to select **COMPLETE MEALS** and press **Enter**.



3 Turn the **Knob** to select **SALMON STEAKS WITH POTATO BAKE** and press **Enter**.



4 Make sure **STANDARD** is selected and then press **Enter**.



5 Place food in the oven by following the directions in the display and the cooking chart. Close the door. Press **START**.



6 After cooking, **EXTEND** will appear. If you wish to extend cooking time, turn the **Knob** to add time and press **START**. If not, press **Stop/Clear**. After the oven has cooled, remove and empty the water tank, wipe oven cavity. Wait a few minutes, then empty the drip tray.



GRILL • ROAST • BAKE

* Suppose you want to cook 4 pieces of Baked Potatoes with Standard time.

PROCEDURE

1 Press **SuperSteam Convection**, turn the **Knob** to select **AUTO** and press **Enter**.

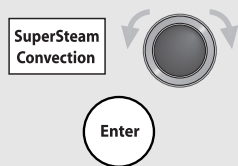

2 Turn the **Knob** to select **BAKE** and press **Enter**.



3 Turn the **Knob** to select **BAKED POTATOES** and press **Enter**.



4 Turn the **Knob** to enter amount (4 pieces) and press **Enter**.



5 Make sure **STANDARD** is selected and then press **Enter**.



6 Press **START** to preheat. No food in oven.



7 When preheat is over, place food in the oven by following the directions in the display and the cooking chart. Close the door.

8 Press **START**.



9 After cooking, **EXTEND** will appear. If you wish to extend cooking time, turn the **Knob** to add time and press **START**. If not, press **Stop/Clear**. After the oven has cooled, remove and empty the water tank, wipe oven cavity. Wait a few minutes, then empty the drip tray.



AUTOMATIC COOKING

NOTES:

1. Enter the weight or amount of the food only (except Complete Meals, Cake and Bread in BAKE). Do not include the weight of the container.
2. For food weighing more or less than weights given in the cooking charts, cook manually.
3. If the oven door is not opened after preheating, the oven will hold the preheat temperature for 30 minutes and then "ENERGY SAVE MODE" will be displayed.
4. Always follow the instructions in the display.
5. The programmed cooking times are average times. To extend cooking times preprogrammed in the automatic cooking, see EXTENDING COOKING TIME AT THE END OF COOKING on page 21.
6. All selections can be programmed with More or Less Time Adjustment. See page 21.
7. Keep the door closed. If opened during cooking, steam will escape and a longer cooking time will be required in SuperSteam Convection and Steam.
8. The amount of water in the water tank is sufficient for one cooking operation. Water does not need to be added during cooking.
9. During and after cooking, condensation may be on the door, oven walls and oven floor. Dry any liquid residue with a soft cloth.
10. After cooking, the display may show "Now cooling". The oven will automatically cool and you will hear the sound of the cooling fan. The fan may continue to operate up to 13 minutes.

WARNINGS:

1. The oven door, outer cabinet and oven cavity will become hot. Use thick oven gloves when adding or removing food to prevent burns.
2. Do not open the oven with your face close to the oven. Steam from the oven may cause burns.

AUTOMATIC COOKING

Steam

Steam has 6 options: Fresh Veg 1, Fresh Veg 2, Frozen Veg, Fresh Fish/Prawns, Frozen Convenience and Rice. Refer to the Steam Chart for details on page 41.

* Suppose you want to cook 0.3 kg of Fresh Veg 1 with Standard time.

PROCEDURE

1 Press **Steam**, turn the **Knob** to select AUTO and press **Enter**.



2 Turn the **Knob** to select FRESH VEG 1 and press **Enter**.



If any examples are shown in the display, check them and press **Enter**.



3 Turn the **Knob** to enter amount (0.3 kg) and press **Enter**.



4 Make sure STANDARD is selected and press **Enter**.



5 Place food in oven. Close the door. Press **START**.



6 After cooking, EXTEND will appear. If you wish to extend cooking time, turn the **Knob** to add time and press **START**.



If not, press **Stop/Clear**. After the oven has cooled, remove and empty the water tank, wipe oven cavity. Wait a few minutes, then empty the drip tray.



NOTES:

1. Enter the weight or amount of the food only. Do not include the weight of the container.
2. For food weighing more or less than weights given in the cooking charts, cook manually.
3. The programmed cooking times are average times. To extend cooking times preprogrammed in the automatic cooking, see EXTENDING COOKING TIME AT THE END OF COOKING on page 21.
4. Any Steam selection can be programmed with More or Less Time Adjustment. See page 21.
5. Keep the door closed. If opened during cooking, steam will escape and a longer cooking time will be required.
6. The amount of water in the water tank is sufficient for one cooking operation. Water does not need to be added during cooking.
7. During and after cooking, condensed water may be on the door, oven walls and oven floor. Dry any liquid residue with a soft cloth.
8. After cooking, the display may show "Now cooling". The oven will automatically cool and you will hear the sound of the cooling fan. The fan may continue to operate up to 13 minutes.

WARNINGS:

1. The oven door, outer cabinet and oven cavity will become hot. Use thick oven gloves when adding or removing foods to prevent burns.
2. Do not open the oven with your face close to the oven. Steam from the oven may cause burns.

AUTOMATIC COOKING

Microwave

AUTO DEFROST

Auto Defrost automatically defrosts all the food shown in the Defrost Chart on page 7 in the cookbook provided.

* Suppose you want to defrost a 0.5 kg steak with Standard time.

PROCEDURE

- 1** Press **Microwave**, turn the **Knob** to select AUTO DEFROST and press **Enter**.

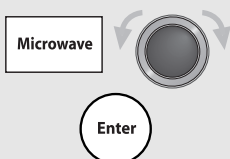

- 2** Turn the **Knob** to select the desired food STEAKS/CHOPS and press **Enter**.



- 3** Turn the **Knob** to select the desired amount (0.5 kg) and press **Enter**.



- 4** Make sure STANDARD is selected and press **Enter**.



- 5** Press **START**.



- 6** The oven will stop and directions will be displayed. Follow the indicated message. Close the door. Press **START**.



- 7** After cooking, **EXTEND** will appear. If you wish to extend defrosting time, turn the **Knob** to add time and press **START**. If not, press **Stop/Clear**.

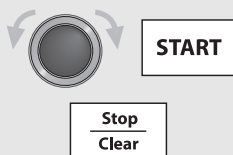

NOTES:

1. Enter the weight of the food only. Do not include the weight of the container.
2. Any Auto Defrost selection can be programmed with More or Less Time Adjustment. See page 21.
3. To defrost other food or food above or below the weights allowed on Defrost Chart, use time and 30% microwave power. See Microwave on page 20.
4. The programmed defrosting times are average times. To extend defrosting times preprogrammed in the automatic operation, see EXTENDING COOKING TIME AT THE END OF COOKING on page 21.
5. Do not use the baking tray, steam tray and metal rack.

SENSOR REHEAT

Sensor Reheat automatically reheat all the food shown in the Sensor Reheat Chart on page 7 in the cookbook provided.

SPECIAL NOTE for SENSOR REHEAT:

1. Wipe off any moisture from the outside of cooking containers and the interior of the oven with a dry cloth or paper towel prior to reheating.
2. After oven is plugged in, wait 2 minutes before using.
3. **SENSOR ERROR** will be displayed if:
 - (a) the sensor does not detect the vapour.
 - (b) the door is opened or the **Stop/Clear** pad is pressed before the cooking time is displayed.To clear, press the **Stop/Clear** pad and reheat manually.

* Suppose you want to reheat 4 cups of soup with Standard time.

PROCEDURE

- 1** Press **Microwave**, turn the **Knob** to select SENSOR REHEAT and press **Enter**.

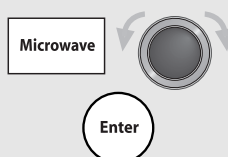

- 2** Turn the **Knob** to select the desired food SOUP and press **Enter**.



- 3** Make sure STANDARD is selected and press **Enter**.



- 4** Press **START**.



* When the sensor detects the vapour from the food, the remaining reheating time will appear.

- 5** After cooking, follow the indicated message.

NOTES:

1. It is not necessary to enter the weight of the food.
2. Any Sensor Reheat selection can be programmed with More or Less Time Adjustment. See page 21.
3. To reheat other food or food above or below the weights allowed on Sensor Reheat Chart, reheat manually. See Microwave on page 20.
4. When reheating small quantities of food on Sensor Reheat, the food may be reheated without displaying any remaining reheating time during the reheating.
5. Do not use the baking tray, steam tray and metal rack.

MANUAL COOKING

Manual Cooking is an option in SuperSteam Convection, Convection, Steam and Microwave. Refer to the Manual Cooking Chart. The chart gives information on each setting.

Manual Cooking Chart

		Preheat *	Temp range	Adjustment temp during cooking	Time range	2 layer cooking	Water tank
SuperSteam Convection	Bake/Roast	YES or NO	100 - 250°C	YES	0 - 2h30m	YES	YES
	Grill	YES or NO	-	-	0 - 2h30m	NO	YES
	Cake	YES or NO	100 - 250°C	YES	0 - 2h30m	YES	YES
	Bread	YES or NO	100 - 250°C	YES	0 - 2h30m	YES	YES
Convection	Oven	YES or NO	100 - 250°C	YES	0 - 2h30m	YES	NO
	Grill	YES or NO	-	-	0 - 2h30m	NO	NO
Steam	High	NO	-	-	0 - 35m	NO	YES
	Low	NO	-	-	0 - 45m	NO	YES
	Reheat	NO	-	-	0 - 35m	NO	YES
	Proof	NO	40°C	-	0 - 2h30m	NO	YES
Microwave	Manual	-	0 - 100% power	-	0 - 1h30m	NO	NO

* Preheat temperature is held for 30 minutes.

COOKING TIME INPUT

Your oven can be programmed for up to 2 hours 30 minutes depending on the cooking mode. Refer to the MANUAL COOKING CHART above. The input unit increment varies from 5 seconds to 5 minutes, depending on the total length of time and cooking mode as shown in the table below.

TEMPERATURE INPUT

Your oven can be programmed for temperatures from 100°C to 250°C, which can be adjusted every 10°C with an initial setting is 180°C.

ITEM	INPUT STEP
Temperature	10°C per step (180°C is initial temperature)
Cooking Time except Microwave	0 - 15 min. : 30 sec. per step
	15 min. - 1 hour : 1 min. per step
	1 hour - Max : 5 min. per step
Cooking Time Microwave	0 - 2 min. : 5 sec. per step
	2 - 5 min. : 10 sec. per step
	5 - 10 min. : 30 sec. per step
	10 - 30 min. : 1 min. per step
	30 - 90 min. : 5 min. per step

MANUAL COOKING

SuperSteam Convection







Manual SuperSteam Convection has 4 functions: SuperSteam Bake/Roast, SuperSteam Grill, SuperSteam Cake and SuperSteam Bread, and each function has 2 options, With Preheat or Without Preheat. Use SuperSteam Convection for cooking food that need to retain moisture and have a crisp brown exterior. For further cooking options refer to cookbook provided.

SUPER STEAM BAKE/ROAST • SUPER STEAM CAKE • SUPER STEAM BREAD

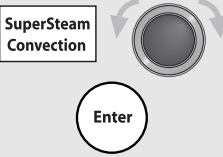
Use these modes for roasting meat and poultry and baking cake/bread with superheated steam. By automatically controlling the superheated steam, food will retain its moisture but have a crisp brown outside. These modes can be programmed for up to 2 hours 30 minutes (2H30). Oven temperature can be set between 100°C and 250°C in 10°C increments.

* Suppose you want to cook for 1 hour and 10 minutes on SuperSteam Bake/Roast (with preheat) at 160°C.

PROCEDURE

- 1** Press **SuperSteam Convection**, turn the **Knob** to select **MANUAL** and press **Enter**.

- 2** Turn the **Knob** to select **SUPER STEAM BAKE/ROAST** and press **Enter**.

- 3** Turn the **Knob** to select **WITH PREHEAT**. Press **Enter**.

- 4** Turn the **Knob** to enter the desired temperature **160°C** and press **Enter**.

- 5** Turn the **Knob** to enter the desired cooking time **1 hour and 10 minutes**.

- 6** Press **START** to preheat. No food in oven.

- 7** When preheat is over, place food in the oven. Close the door.

- 8** Press **START**.



- 9** After cooking, **EXTEND** will appear. If you wish to extend cooking time, turn the **Knob** to add time and press **START**. If not, press **Stop/Clear**. After the oven has cooled, remove and empty the water tank, wipe oven cavity. Wait a few minutes, then empty the drip tray.



MANUAL COOKING

SUPER STEAM GRILL

Use this mode for grilling meat, poultry and ready-made snacks with superheated steam. By automatically controlling the superheated steam food will retain its moisture but have a crisp brown outside.

This mode can be programmed for up to 2 hours 30 minutes (2H30).

* Suppose you want to cook for 15 minutes on SuperSteam Grill (with preheat).

PROCEDURE

1 Press **SuperSteam Convection**, turn the **Knob** to select **MANUAL** and press **Enter**.

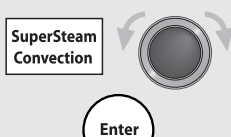

2 Turn the **Knob** to select **SUPER STEAM GRILL** and press **Enter**.



3 Turn the **Knob** to select **WITH PREHEAT**. Press **Enter**.



4 Turn the **Knob** to enter the desired cooking time 15 minutes.



5 Press **START** to preheat. No food in oven.



6 When preheat is over, place food in the oven. Close the door.

7 Press **START**.



8 After cooking, **EXTEND** will appear. If you wish to extend cooking time, turn the **Knob** to add time and press **START**. If not, press **Stop/Clear**. After the oven has cooled, remove and empty the water tank, wipe oven cavity. Wait a few minutes, then empty the drip tray.

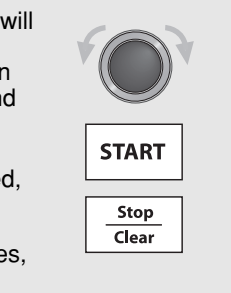

NOTES:

1. If the oven door is not opened after preheating, the oven will hold the preheat temperature for 30 minutes and then "ENERGY SAVE MODE" will be displayed.
2. To program only preheat, press **START** after entering the desired preheat temperature. For SuperSteam Grill, press **START** after selecting **WITH PREHEAT**. Preheat will start. When the oven reaches the programmed temperature, follow the message in the display.
3. To extend cooking time, see **EXTENDING COOKING TIME AT THE END OF COOKING** on page 21.
4. Keep the door closed. If opened during cooking, steam will escape and a longer cooking time will be required.
5. The amount of water in the water tank is sufficient for one cooking operation. Water does not need to be added during cooking.
6. During and after cooking, condensation may be on the door, oven walls and oven floor. Dry any liquid residue with a soft cloth.
7. After cooking, the display may show "Now cooling". The oven will automatically cool and you will hear the sound of the cooling fan. The fan may continue to operate up to 13 minutes.

WARNINGS:

1. The oven door, outer cabinet and oven cavity will become hot. Use thick oven gloves when adding or removing food to prevent burns.
2. Do not open the oven with your face close to the oven. Steam from the oven may cause burns.

MANUAL COOKING

Convection







Manual Convection has 2 functions, Oven and Grill, and each function has 2 options, With Preheat or Without Preheat. Use Convection as you would use a conventional oven. There is no need to change traditional cooking times. This mode does not use steam. This mode can be programmed for up to 2 hours 30 minutes (2H30). Oven temperature can be set between 100°C and 250°C by 10°C increments. Grill is a pre-set temperature, so oven temperature cannot be changed.

OVEN

* Suppose you want to cook for 10 minutes on Oven (with preheat) at 250°C.

PROCEDURE





- 1 Press **Convection**, turn the **Knob** to select **OVEN** and press **Enter**.

- 2 Turn the **Knob** to select **WITH PREHEAT**. Press **Enter**.

- 3 Turn the **Knob** to enter the desired temperature **250°C** and press **Enter**.

- 4 Turn the **Knob** to enter the desired cooking time **10 minutes**.

- 5 Press **START** to preheat. No food in oven.

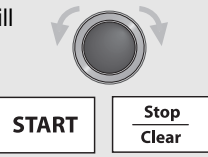
- 6 When preheat is over, place food in the oven. Close the door.
- 7 Press **START**.

- 8 After cooking, **EXTEND** will appear. If you wish to extend cooking time, turn the **Knob** to add time and press **START**. If not, press **Stop/Clear**.

GRILL

* Suppose you want to cook for 20 minutes on Grill (with preheat).

PROCEDURE

- 1 Press **Convection**, turn the **Knob** to select **GRILL** and press **Enter**.

- 2 Turn the **Knob** to select **WITH PREHEAT**. Press **Enter**.

- 3 Turn the **Knob** to enter the desired cooking time **20 minutes**.

- 4 Press **START** to preheat. No food in oven.

- 5 When preheat is over, place food in the oven. Close the door.
- 6 Press **START**.

- 7 After cooking, **EXTEND** will appear. If you wish to extend cooking time, turn the **Knob** to add time and press **START**. If not, press **Stop/Clear**.

WARNINGS:

1. The oven door, outer cabinet and oven cavity will become hot. Use thick oven gloves when adding or removing foods to prevent burns.
2. Do not open the oven with your face close to the oven. Steam from the oven may cause burns.

NOTES:

1. If the oven door is not opened after preheating, the oven will hold the preheat temperature for 30 minutes and then "ENERGY SAVE MODE" will be displayed.
2. To program only preheat, press **START** after entering the desired preheat temperature. For Grill, press **START** after selecting WITH PREHEAT. Preheat will start. When the oven reaches the programmed temperature, follow the message in the display.
3. To extend cooking times, see **EXTENDING COOKING TIME AT THE END OF COOKING** on page 21.
4. Keep the door closed. If opened during cooking, heat will escape and a longer cooking time will be required.
5. After cooking, the display may show "Now cooling". The oven will automatically cool and you will hear the sound of the cooling fan. The fan may continue to operate up to 13 minutes.

MANUAL COOKING

Steam

STEAM has 4 functions: Steam High, Steam Low, Steam Reheat and Proof.

STEAM HIGH • STEAM LOW

Use Steam High to steam foods such as chicken or vegetables. Use Steam Low to steam fish or egg custard gently. With Steam Low mode, cooking time is a little longer than Steam High mode. Steam cooks food gently without destroying shape, colour or aroma. The Steam High can be programmed for up to 35 minutes (35.00). The Steam Low can be programmed for up to 45 minutes (45.00).

* Suppose you want to cook for 20 minutes on Steam High.

PROCEDURE

1 Press **Steam**, turn the **Knob** to select **MANUAL** and press **Enter**.

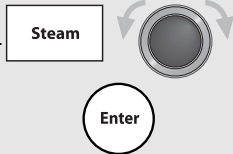

2 Turn the **Knob** to select **STEAM HIGH** and press **Enter**.



3 Turn the **Knob** to enter the desired cooking time 20 minutes.



4 Press **START**.



5 After cooking, **EXTEND** will appear. If you wish to extend cooking time, turn the **Knob** to add time and press **START**. If not, press **Stop/Clear**. After the oven has cooled, remove and empty the water tank, wipe oven cavity. Wait a few minutes, then empty the drip tray.



STEAM REHEAT

Use Steam Reheat to reheat gently without drying. Use Steam Reheat to reheat foods in metal container. Cooking time is longer than microwave oven. Steam Reheat can be programmed for up to 35 minutes (35.00).

* Suppose you want to reheat for 20 minutes on Steam Reheat.

PROCEDURE

1 Press **Steam**, turn the **Knob** to select **MANUAL** and press **Enter**.

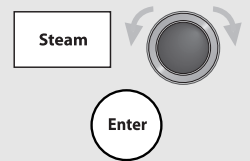

2 Turn the **Knob** to select **STEAM REHEAT** and press **Enter**.



3 Turn the **Knob** to enter the desired cooking time 20 minutes.



4 Press **START**.



5 After cooking, **EXTEND** will appear. If you wish to extend cooking time, turn the **Knob** to add time and press **START**. If not, press **Stop/Clear**. After the oven has cooled, remove and empty the water tank, wipe oven cavity. Wait a few minutes, then empty the drip tray.



MANUAL COOKING

PROOF

Use Proof to aid dough rising when making regular or sweet yeast breads. Proof can be programmed for up to 2 hours 30 minutes (2H30).

* Suppose you want to proof for 20 minutes.

PROCEDURE

- 1** Press **Steam**, turn the **Knob** to select **MANUAL** and press **Enter**.

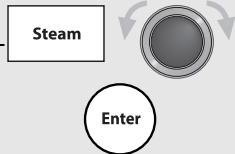

- 2** Turn the **Knob** to select **PROOF** and press **Enter**.



- 3** Turn the **Knob** to enter the desired proofing time 20 minutes.



- 4** Press **START**.



- 5** After proofing, **EXTEND** will appear. If you wish to extend proofing time, turn the **Knob** to add time and press **START**. If not, press **Stop/Clear**. After the oven has cooled, remove and empty the water tank, wipe oven cavity. Wait a few minutes, then empty the drip tray.



NOTES:

1. To extend steaming time, see **EXTENDING COOKING TIME AT THE END OF COOKING** on page 21.
2. Keep the door closed. If opened during cooking, steam will escape and a longer cooking time will be required.
3. The amount of water in the water tank is sufficient for one cooking operation. Water does not need to be added during cooking.
4. During and after cooking, condensation may be on the door, oven walls and oven floor. Dry any liquid residue with a soft cloth.
5. After cooking, the display may show "Now cooling". The oven will automatically cool and you will hear the sound of the cooling fan. The fan may continue to operate up to 13 minutes.

WARNINGS:

1. The oven door, outer cabinet and oven cavity will become hot. Use thick oven gloves when adding or removing foods to prevent burns.
2. Do not open the oven with your face close to the oven. Steam from the oven may cause burns.

MANUAL COOKING

Microwave

Microwave is fast and convenient for cooking, reheating and defrosting.

There are six different power levels.

Power level	Examples
100%	Raw meat, Vegetables, Rice or Pasta
70%	Delicate Food such as Eggs or Seafood.
50%	
30%	Defrost, Softening butter
10%	Keep food warm
0%	

This variable cooking control allows you to select the rate of microwave cooking.

If a power level is not selected, then 100% is automatically used.

* Suppose you want to cook for 5 minutes on 100%.

PROCEDURE

- 1 Press **Microwave**, turn the **Knob** to select MANUAL and press **Enter**.

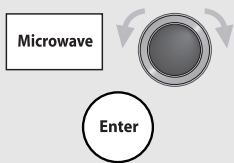

- 2 Turn the **Knob** to enter the desired cooking time 5 minutes and press **START**.



To change the power, turn the Knob. To lower power level, turn the Knob to the left.

* Suppose you want to defrost for 5 minutes on 30%.

PROCEDURE

- 1 Press **Microwave**, turn the **Knob** to select MANUAL and press **Enter**.



- 2 Turn the **Knob** to enter defrosting time 5 minutes and press **Enter**.



- 3 Turn the **Knob** to select power level 30%.



- 4 Press **START**.



NOTES:

1. After cooking, the display may show "Now cooling". The oven will automatically cool and you will hear the sound of the cooling fan. The fan may continue to operate up to 13 minutes.
2. Do not use the baking tray, steam tray and metal rack.

HINT:

For cooking cake or meatloaf, place the container on up-turned heat-resistant shallow dish.

OTHER CONVENIENT FEATURES

Automatic Cooking Time Adjustment (More or Less Time Adjustment)

You can adjust cooking results as you like. The automatic settings can be adjusted to your preferred result with the MORE/LESS option. Select MORE or LESS in the display before **START**.

Extending Cooking Time at the End of Cooking

Cooking results may vary depending on room temperature, initial food temperature and other factors. You can adjust cooking results by adding more cooking time at the end. When cooking is finished, the display will show "EXTEND". It is only possible to add extra time during the 5 minutes when "EXTEND" is displayed. The time can be extended up to 10-30 minutes depending on cooking mode. Turn the **Knob** for the desired time and then press **START**. The same cooking mode will be continued except for SuperSteam Convection. Convection mode will be continued for SuperSteam Convection. Carefully check the cooking process.

NOTES:

1. If "Fill water tank with water" is displayed when **START** is pressed, fill the water tank to the 2 mark (MAX mark). Position and push firmly into place.
2. Extend mode is canceled when **Stop/Clear** is pressed.
3. EXTEND is available depending on the cooking mode. See below. The Extending Cooking Time function can be repeated until the food is cooked as you desire.

		Extend time at end
SuperSteam Convection	Auto	0 - 30 min
	Manual	0 - 30 min
Convection	Manual	0 - 30 min
Steam	Auto	0 - 10 min
	Manual	0 - 10 min
Microwave	Auto Defrost	0 - 10 min
	Sensor Reheat	No
	Manual	No

Temperature Adjustment

To change the oven temperature during cooking in Manual Operation with SuperSteam Convection Bake/Roast, SuperSteam Convection Cake, SuperSteam Convection Bread and Convection Oven, simply turn the **Knob** to increase or decrease in 10°C increments and then press **Enter**.

If **Enter** is not pressed within 5 seconds, the temperature will revert to the initial temperature that you selected.

End of Cooking Reminder

At end of cooking, the oven will signal and repeat after 2 and 4 minutes unless door is opened or **Stop/Clear** is pressed.

OTHER CONVENIENT FEATURES

Multiple Sequence Cooking

SUPER STEAM CONVECTION AND CONVECTION

There are 2 patterns in Super Steam Convection and Convection which can be programmed into Multiple Sequence Cooking.

- ① Preheat + Convection (Oven) + Convection (Oven)
 - ② Preheat + SuperSteam Convection (SuperSteam Bake/Roast) + Convection (Oven)
- Preheat can be omitted.

* Suppose you want to cook in Sequence Cooking with Preheating in pattern ②.

1st stage is SuperSteam Bake/Roast, at 160°C for 1 hour and 10 minutes.

2nd stage is Convection Oven, at 230°C for 10 minutes.

PROCEDURE

1 For 1st stage, follow the steps 1 to 5 in SuperSteam Bake/Roast. See page 15.

2 Press **Convection** to program the second stage.

Convection

3 Turn the **Knob** to enter the desired temperature 230°C and press **Enter**.



4 Turn the **Knob** to enter the desired cooking time 10 minutes.



5 Press **START**.

START

MICROWAVE

Your oven can be programmed for up to 4 automatic cooking sequences, switching from one power level setting to another automatically. Sometimes cooking directions tell you to start on one power level and then change to a different power level.

- Suppose you want to cook for 5 minutes at 30% and then continue to cook for 30 minutes at 50%.

PROCEDURE

1 For 1st stage, follow the steps 1 to 3 in manual microwave cooking. See page 20.

2 Press **Microwave** to program the second stage.

Microwave

3 Turn the **Knob** to enter cooking time 30 minutes and press **Enter** to proceed.



4 Turn the **Knob** to select power level 50%.



5 Press **START**.

START

OTHER CONVENIENT FEATURES

Info

Back/Info provides 7 features and step-by-step instructions for special functions.

MAINTENANCE	SETTINGS
DRAIN WATER DESCALE STEAM CLEAN	CONTRAST CHILD LOCK DEMO MODE WATER HARDNESS

These features can be selected by pressing **Back/Info** in home page (displayed ENERGY SAVE MODE) and then turning the **Knob** and pressing **Enter**.

DRAIN WATER

The remaining water inside the steam generator can be evaporated by using the DRAIN WATER function. See page 8.

DESCALE

See page 8.

STEAM CLEAN

See page 24.

CONTRAST

Contrast can adjust display darkness or brightness.

PROCEDURE

- 1 Press **Back/Info**, turn the **Knob** to select CONTRAST and press **Enter**.
- 2 Turn the **Knob** to adjust contrast and press **Enter** to keep the adjustment. The contrast setting will be held in the memory even if the oven power is off.

CHILD LOCK

Child Lock prevents unwanted oven operations by small children. The oven can be set so that the control panel is deactivated and locked.

PROCEDURE

- 1 Press **Back/Info**, turn the **Knob** to select CHILD LOCK and press **Enter**.
- 2 Press **Enter**.

NOTES:

1. To cancel Child Lock, press **Enter** and hold for 3 seconds.
2. If you set Child Lock, energy save mode will be cancelled.
3. When the oven power is off, the setting returns to OFF.

DEMO MODE

Cooking operations and special features can be demonstrated with no power in the oven.

PROCEDURE

- 1 Press **Back/Info**, turn the **Knob** to select DEMO MODE and press **Enter**.
- 2 Turn the **Knob** to select DEMO ON and press **Enter**.

NOTE:

1. To cancel Demonstration Mode, select DEMO OFF at step 2 or unplug the oven from the electrical outlet and re-plug. "ENERGY SAVE MODE" will be displayed.
2. If you set Demo Mode, energy save mode will be cancelled.

WATER HARDNESS

Your oven is set at the factory to water hardness setting 2 (Hard). You can set the oven for the water hardness level.

You can use the test strip supplied to check the water hardness level.

HOW TO USE THE TEST STRIP SUPPLIED:

1. Put the test strip into the water you want to use for 1 second, then remove it.
2. Shake off excess water.
3. Wait 15 seconds, and compare colour change on the test strip to colour chart and the table below.

When you use other test strips, follow the instructions of them.

Hardness level	Hardness range	Setting
1	<120 ppm <120 mg/l <6.7 °dH	Soft
2	120 - 250 ppm 120 - 250 mg/l 6.7 - 14.0 °dH	Hard
3	>250 ppm >250 mg/l >14.0 °dH	Very hard

PROCEDURE

- 1 Press **Back/Info**, turn the **Knob** to select WATER HARDNESS and press **Enter**.
- 2 Turn the **Knob** to select desired hardness level and press **Enter**. The water hardness setting will be held in the memory even if the oven power is off.

CLEANING AND CARE

CLEAN THE OVEN AT REGULAR INTERVALS -

Keep the oven clean and remove any food deposits, which lead to deterioration of the surface. This could adversely affect the life of the appliance and possibly result in a hazardous situation.

IMPORTANT CAUTIONS:

- DISCONNECT THE POWER CORD BEFORE CLEANING OR LEAVE THE DOOR OPEN TO INACTIVATE THE OVEN DURING CLEANING.
- BEFORE CLEANING, MAKE SURE THE OVEN IS COMPLETELY COOL.
- DO NOT USE OVEN CLEANERS, ABRASIVE, HARSH CLEANERS OR SCOURING PADS ON ANY PART OF YOUR OVEN.
- DO NOT USE A STEAM CLEANER.

Oven Cleaning - Exterior

The outside may be cleaned with mild soap and warm water. Wipe clean with a damp cloth. Avoid the use of harsh abrasive cleaners. Keep the ventilation openings free of dust.

Door

Wipe the door and window on both sides, the door seals and adjacent parts frequently with a damp cloth to remove any spills or spatters. Do not use harsh abrasive cleaners or sharp metal scrapers to clean the oven door glass since they can scratch the surface, which may result in shattering of the glass.

Control Panel

Care should be taken in cleaning the control panel. If the control panel becomes soiled, open the oven door before cleaning. Wipe the panel with a cloth dampened slightly with water only. Dry with a soft cloth. Do not scrub or use any sort of chemical cleaners. Close the door and press **Stop/Clear**.

Oven Cleaning - Interior

Steam Clean

The Steam Clean function helps to loosen any grease, oil or food residue. The steam will make the oven easy to clean; however, it is not a self-cleaning function. It will take approximately 20 minutes for the cleaning cycle.

PREPARATION

1. Make sure that the water tank is filled with room temperature water suitable for drinking (filtered) and is installed. (See page 6.)
2. Make sure that the empty drip tray is installed. (See page 6.)

PROCEDURE

- 1 Press **Back/Info**, turn the **Knob** to select **STEAM CLEAN** and press **Enter**.

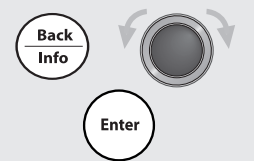

- 2 Press **START**.

START

Allow the oven to cool to prevent burns. Then open the door and remove any residue carefully with a soft damp cloth. Finally, remove and empty the water tank. Wait a few minutes, then empty the drip tray.

To clean the interior surfaces, wipe with a soft cloth and warm water.

1. After every use while the oven is still warm, wipe spatters or spills with a soft damp cloth or sponge. **DO NOT USE ABRASIVE OR HARSH CLEANERS OR SCOURING PADS.** For heavier soil, use mild soap; rinse thoroughly with hot water. Carry out Steam Clean function to clean thoroughly.
2. The cleaning cloth or sponge must be wrung dry to prevent moisture or residue from entering the oven vents.
3. Do not use spray type cleaners on the oven interior.
4. Any remaining food or fat could cause smoke or an unpleasant smell. It is a good idea to heat the oven with SuperSteam Convection Grill in manual operation for 20 minutes without preheat and food to remove any fat or residue from the interior ducts and heaters and to remove any unpleasant smell. See **CLEAN THE OVEN BEFORE FIRST USE** on page 9.

CLEANING AND CARE

Door Seals

Always keep the door seals clean to prevent any damage. If water condenses inside the door seals, wipe dry with a soft cloth. Polish with another soft cloth. Do not use a chemical or abrasive cleaner on these surfaces. Care should be taken not to rub, damage, pull or move the seals. Before cooking, always check that door seal is smooth and flat. If not, steam will leak from the door. Do not use the oven if it has a damaged door seal. Contact a SERVICE CENTRE APPROVED BY SHARP.

Baking Tray / Rack

Wash baking tray and rack after cooking with a mild soap or detergent solution, rinsing and polishing dry. Do not use harsh cleaners, sharp metal scrapers or stiff brushes to prevent damage to the easy clean surface. All the accessories can be washed in the dishwasher.

Water Tank and Water Tank Lid

After cooking, wash in a mild soap or detergent solution with a soft damp cloth or sponge, rinse and polish dry. Do not wash in the dishwasher. Note the filter in the rear bottom of the water tank. Use a very soft brush to remove any build-up in the filter. The filter cannot be removed nor replaced so special care should be taken not to tear the mesh of the filter when cleaning it. Do not use harsh cleaners, sharp metal scrapers or stiff brushes on the water tank, water tank lid and the filter. Do not use a torn filter. Order replacement. Contact a SERVICE CENTRE APPROVED BY SHARP.

Drip Tray and Drip Tray Lid

Empty drip tray after cooking, wash in a mild soap or detergent solution with a soft damp cloth or sponge, rinse, polish dry and replace below the oven front. Do not wash in the dishwasher.

Descaling of the Oven's Steam Parts

During steam production, scale may form in the steam generator. To remove scale, carry out descale function when DESCALING IS NECESSARY. is shown in the display. See page 8 for complete instructions.

TROUBLESHOOTING CHART

If EE is displayed or you think the oven is not working properly, check the chart below before consulting a SERVICE CENTRE APPROVED BY SHARP. This will help to prevent unnecessary service calls.

WARNING:

Never adjust, repair or modify the oven by yourself. It is hazardous for anyone other than a qualified service technician trained by SHARP to carry out any service or repair operation. This is important as it may involve the removal of covers that provide protection against electrical parts.

- Repairs and Modifications: Do not attempt to operate the oven if it is not working properly.
- Outer cabinet & Lamp Access: Never remove the outer cabinet to avoid the possibility of electric shock or burns.

Troubleshooting Chart

ERROR MESSAGE / INFORMATION MESSAGE

MESSAGE ON DISPLAY		ACTION
ERROR MESSAGE	EE	Due to technical error, contact a SERVICE CENTRE APPROVED BY SHARP.
INFORMATION MESSAGE	SENSOR ERROR	SENSOR ERROR will be shown if: (a) the sensor does not detect the vapour. (b) the door is opened or the Stop/Clear pad is pressed before the cooking time is displayed. To clear the message, press the Stop/Clear pad and cook manually.
	Wait. Oven is too warm to use.	The oven is too hot to use Microwave for defrosting or Steam Manual Proof. Remove food from oven and allow to cool until the message clears.
	Water is frozen. Please refer to instructions in operation manual.	The oven may not operate properly. Operate the oven with Convection Grill without food and preheat for 5 minutes. See page 17.
	Now cooling.	After cooking, the oven and the oven parts will be hot. Now cooling is shown in the display until the oven cavity has cooled. The cooling fan may continue to operate up to 13 minutes. Now cooling will disappear when the oven has cooled. If you wish to use the warm oven, simply press Stop/Clear .
	Replace drip tray.	Remove and replace the drip tray correctly. See page 6. In case the drip tray is not installed correctly, Replace drip tray will be shown in the display.
	Empty drip tray and replace.	Empty drip tray and replace will be shown in the display when water remains in the drip tray. You must empty the drip tray and replace it before SuperSteam Convection or Steam Cooking will start. See page 6.
	Descaling is necessary.	Follow step-by-step instructions for descaling. See page 8.
	Fill water tank with water.	Remove water tank and fill with water to the 2 mark (MAX mark). Replace and push firmly into place. NOTE: Ensure you do not use any other liquids like distilled water, mineral water and etc.
	Remove water tank	If water is in the water tank, Drain Water function will not start. Remove the water tank before starting Drain Water.
	Hot	The oven cabinet and oven cavity are very hot. Pay extra attention not to burn yourself.

TROUBLESHOOTING CHART

The following situations are normal and are not signs that the oven is malfunctioning.

QUESTION / SITUATION		ANSWER
Control panel / power supply	The display is black / blank.	<ul style="list-style-type: none"> * Open the door and close. * Check the power plug is properly connected to a suitable wall outlet. * Check the wall socket and fuse are functioning properly. * Disconnect the power cord, wait for a minute, then reconnect.
	The display is fine but START will not function when pressed.	<ul style="list-style-type: none"> * Open the door and close. Is the oven light off? Press START again. * If the message "Wait. Oven is too warm to use." is displayed, wait until the message has disappeared.
	Electrical power supply is interrupted during cooking.	The programmed cooking time and mode will be cancelled. Continue to cook with manual mode.
	Oven light is off during PROOF mode.	Normal operation to prevent bread dough from drying on the surface.
	Oven light is off during descaling.	This is normal operation. See page 8.
	Oven light is off when door is opened.	Oven light will turn OFF if the door is open for more than 5 minutes.



TROUBLESHOOTING CHART

The following situations are normal and are not signs that the oven is malfunctioning.

QUESTION / SITUATION		ANSWER
Steam	Water is found inside the oven when the door is opened.	Steam has condensed inside the oven. Wipe dry with a soft cloth or a sponge after cooling.
	Steam comes out of the air ventilation openings at the top of the oven.	It is normal for used steam to come from the air ventilation opening on the top of the oven.
	Condensation can be seen in the oven cavity.	This operation is normal. Steam has condensed on the oven floor. Wipe dry with a soft cloth or a sponge after cooling.
	Steam comes from the door during cooking.	Check the door seals to make sure it is lying smooth and flat.
Noise / Sound	Noise during microwave cooking.	When microwaving, you may hear the magnetron cycling on and off depending on the power level.
	Noise after cooking.	The cooling fan will operate until the oven is cool. The fan may continue to operate up to 13 minutes.
	Noise when cooking with high temperature.	High temperatures may cause expansion of the oven's components. This is normal.
Smoke / Aroma	When using the oven for the first time, it may smoke or smell.	See page 9 for step-by-step instructions for cleaning the oven before the first use.
	The oven cavity smells after cooking.	See CLEAN THE OVEN BEFORE FIRST USE on page 9 for step-by-step instructions for removing the aroma.
Others	Time appearing in the display is counting down very rapidly.	Check Demonstration Mode on page 23 and cancel.

SERVICE CALL CHECK

Check the following before calling service:

1. Does the display light when the door is opened and closed? Yes _____ No _____
2. When the door is opened, is the oven lamp switched on? Yes _____ No _____
3. Place one cup of water (approx. 250 ml) in a glass measure in the oven and close the door securely.
Oven lamp should go off if door is closed properly.
Programme the oven for one minute on Microwave 100%. At this moment:
 - A. Does the oven lamp light? Yes _____ No _____
 - B. Does the cooling fan work? Yes _____ No _____
(Put your hand over the ventilation openings.)
 - C. Does the Microwave icon  appear on the display? Yes _____ No _____
 - D. After one minute, did an audible signal sound? Yes _____ No _____
 - E. Is the water inside the oven hot? Yes _____ No _____
4. Remove water from the oven and programme the oven for 5 minutes on Convection, Oven 250°C.
 - A. Does the Convection icon  appear on the display? Yes _____ No _____
 - B. After the oven stops, is the inside of the oven hot? Yes _____ No _____
5. Fill the water tank with water and replace.
Operate the oven for 3 minutes on Manual Steam High.
 - A. After the oven stops, is the inside of the oven filled with steam? Yes _____ No _____

If "NO" is the answer to any of the above questions, please check your wall socket and the fuse in your meter box. If both the wall socket and the fuse are functioning properly, CONTACT YOUR NEAREST SERVICE CENTRE APPROVED BY SHARP.

IMPORTANT: If the display shows nothing even if the power supply plug is properly connected, the Energy Save Mode may be in operation. Open and close the oven door to operate the oven. See "Getting Started" on page 9.

NOTES:

1. If time in the display is counting down very rapidly, check Demonstration Mode. (Please see page 23 for detail.)
2. If the oven is set for more than about 8 minutes on Microwave 800W power level, output power will be reduced to avoid overheating. Finally the output power will be 600W after 9 minutes.

SPECIFICATIONS

AC Line Voltage	:	Single phase 230 - 240V, 50Hz.
AC Power Required	:	
Microwave	:	1.16 kW
Convection	:	1.55 kW
Output Power	:	
Microwave	:	800 W* (IEC test procedure)
Convection	:	1.45 kW
Steam heating element	:	1.25 kW
Microwave Frequency	:	2450 MHz** (Class B/Group 2)
Outside Dimensions	:	553 mm(W) x 438 mm(H) x 483 mm(D)***
Weight	:	Approx. 24 kg

* When tested in accordance with AS/NZS 2895.1.2007.

** This is the classification of ISM (Industrial, Scientific and Medical) equipment described in the International Standard CISPR11.

*** The depth does not include the door opening handle and knob.

COOKING GUIDES

About Your Oven

This Operation Manual is valuable: read it carefully and always save it for reference.

Be aware that, unlike microwave-only ovens, Super Steam Ovens have a tendency to become hot during cooking with **SuperSteam Convection, Convection or Steam**.

About Cooking Options

Your oven has a variety of cooking options that are divided into automatic and manual. SuperSteam Convection, Steam and Microwave have both automatic and manual choices. Convection has only manual.

SuperSteam Convection

Helps remove extra fat and reduce calories whilst preserving the moisture and flavour in food. Complete Meal option for cooking meals conveniently. LCD display and pre-programmed settings assure good results.

Steam

Gentle cooking helps retain moisture, natural flavours and nutrients. Ideal for seafood, meat, vegetable and dumpling dishes.

Convection

Browns, bakes, grills and crisps a wide variety of food. Two-layer convection baking for cookies, cakes, muffins and biscuits.

Microwave

800W microwave power for fast and convenient microwave cooking and defrosting. Pre-programmed sensor menus eliminate guesswork when reheating popular items.

COOKING GUIDES

About Utensils and Coverings

The chart below will help you decide what utensils and coverings should be used in each mode.

Utensils - Coverings \ Cooking Mode	SuperSteam Convection / Convection	Steam	Microwave
Aluminium Foil, Foil Containers	YES	YES	YES Small flat pieces of aluminum foil placed smoothly on food can be used to shield areas from cooking or defrosting too quickly. Keep foil at least 2 cm from walls of oven.
Metal	YES	YES	NO
China, Ceramics,	YES Oven-proof porcelain, pottery, glazed earthenware and bone china are usually suitable. Do not use the container if it has a flaw.	YES	YES Check manufacturer's recommendation for being microwave safe. Do not use the container if it has a flaw.
Heat-resistant Glassware e.g. Pyrex®	YES Care should be taken if using fine glassware as it can break or crack if heated suddenly.	YES	YES
Plastic/Polystyrene heat-resistant temp. over 140°C	NO	YES Care must be taken as some containers warp, melt or discolour at high temperatures.	YES Use microwave-safe plastic containers for reheating and defrosting. Some microwave-safe plastics are not suitable for cooking foods with high and sugar content. Follow manufacturer's directions.
Plastic Wrap heat-resistant temp. over 140°C	NO	YES	YES
Paper Towel, Paper Plates	NO	NO	YES Paper towel: To cover for reheating and cooking. Do not use recycled paper towels which may contain metal filings. Paper plates: For reheating.
Containers made of synthetic material	NO They could melt at high temperature.	NO	NO
Baking paper	YES Do not touch the oven wall as it may be burnt. Keep the heat-resistant temp.	YES	NO
Roasting Bags	YES Roasting bags should only be used with Convection Oven.	NO	YES Follow manufacturer's directions.
Silver Dishes and Cooking Utensils or Containers that might rust inside the oven.	NO	NO	NO
Rack, Baking Tray	YES	YES	NO

Utensils should be checked to ensure that they are suitable for use in each cooking mode. When heating food in plastic containers, pay special attention to the melting temperature of the containers. Do not heat the plastic containers at over their specified melting temperature. Keep an eye on the oven in case of melting and ignition.

COOKING GUIDES

ACCESSORIES There are many microwave or heat-resistant accessories available for purchase. Evaluate carefully before you purchase so that they meet your needs. A microwave-safe thermometer will assist you in determining correct cooking result and assure you that food has been cooked to safe temperatures when using microwave-only cooking. Sharp is not responsible for any damage to the oven when accessories are used.

For automatic cooking, use the recommended container in the cooking chart in this operation manual or the cookbook supplied.

SuperSteam Convection and Steam Cooking Advice

There are certain techniques for cooking with steam. It is essential that these techniques are followed to ensure good results. Many of them are similar to those used in conventional cooking so you may be used to doing them already. Please follow the advise given below for all cooking options which use SUPERSTEAM CONVECTION and STEAM.

NOTE:

- Always attend the oven when in use.
- Ensure that the utensils are suitable for each cooking mode. (See About Utensils and Coverings page 31)
- Ventilate the room to allow the steam to dissipate.
- After cooking and the oven has cooled, remove and empty the water tank, wipe oven cavity with a soft cloth or sponge. Wait a few minutes, then empty the drip tray.

WARNING:

Follow instructions in the SHARP operation manual at all times. If you exceed recommended cooking times and use oven temperature that are too high, food may overheat, burn and, in extreme circumstances, catch fire and damage the oven.

- Special advice for STEAM -

Cooking Techniques	
Container	Ensure food is arranged evenly. Food which has little or no space between will take longer to cook, please ensure food is positioned with enough space between items to allow the steam to circulate around it. For the container, a shallow dish is suitable. It is not recommended to use dense dishes, because of the thickness of such dishes, recommended cooking times will have to be extended. For efficiently reducing salt and fat, please put the food directly on rack. If the food is put on the plate, please discard the drips left on the plate.
Covering	Covering is not necessary in most cases. If a cover is required, aluminium foil is recommended to keep food becoming wet from the condensed water in the oven cavity. Covered food will take longer to cook.
Door	For accurate cooking times, keep the door closed.
Stir	Sometimes soup or casserole reheated in a casserole dish without covering may look watery after cooking. Appearance will be better when stirred.
Stand	Standing time is recommended after cooking so it enables the heat to disperse equally throughout the food. Do not allow to stand for a long time; food may be overcooked or wet by the residual steam.

Cooking Hints	
Blanching	STEAM can be used to blanch vegetables to prepare them for freezing. Place the prepared vegetables on a plate and cook with STEAM, MANUAL, STEAM HIGH for 4 to 5 minutes. After that, put in the cold water to cool quickly. Dry them and then freeze.
Salty Food	For certain salty food like salty fish, bacon etc., salty taste can be reduced by steaming before cooking. Place salty food on rack directly and STEAM, MANUAL, STEAM HIGH for 4 to 5 minutes.

COOKING GUIDES

- Advice for SUPERSTEAM CONVECTION and STEAM -

Food characteristics	
Density	Food density will affect the amount of cooking time needed. Cut the food into thinner parts if possible, and arrange in single layer.
Quantity	The cooking time must be increased as the amount of food cooked in the oven increases.
Size	Small pieces cook faster than larger ones, as heat can penetrate from all sides to the centre. For even cooking make all the pieces the same size.
Shape	Food that is irregular in shape, such as chicken breasts or drumsticks, may take longer to cook in the thicker parts. Check that these parts are cooked thoroughly before serving.
Temperature of food	The initial temperature of food affects the amount of cooking time needed. Chilled food will take longer to cook than food at room temperature. The temperature of the container is not the actual temperature of the food or drink.
Seasoning & flavouring	Seasoning or flavouring is best added after cooking. If added as a marinade or rub, the taste may become light when cooking with steam. Add seasoning or flavouring again after cooking if necessary.

NOTE:

- Ensure the food is thoroughly cooked / reheated before serving.
- Cooking time will be affected by the shape, depth, quantity and temperature of food together with the size, shape and material of the container.
- Never heat oil or fat for deep frying as this may lead to overheating and fire. Care should be taken for foods high in fat or sugar (e.g. Christmas pudding) as overheating can lead to fire.

Face & Hands: Always use thick oven gloves to remove food or cookware from the oven. Be careful when opening the oven door to allow steam to dissipate. Do not remove the food from the oven with your bare hand.

Check the temperature of food and drink and stir before serving. Take special care when serving to babies, children or the elderly.

COOKING GUIDES

Microwave Cooking Advice

- Special Notes and Warning for MICROWAVE -

	DO	DON'T
Eggs, fruits, nuts, seeds, vegetables, sausages and oysters	<ul style="list-style-type: none"> * Puncture egg yolks and whites and oysters before cooking to prevent "explosion". * Pierce skins of potatoes, apples, squash, hot dogs, sausages and oysters so that steam escapes. 	<ul style="list-style-type: none"> * Cook eggs in shells. This prevents "explosion", which may damage the oven or injure yourself. * Cook hard/soft boiled eggs. * Overcook oysters. * Dry nuts or seeds in shells.
Popcorn	<ul style="list-style-type: none"> * Use specially bagged popcorn for the microwave oven. * Listen while popping corn for the popping to slow to 1-2 seconds. 	<ul style="list-style-type: none"> * Pop popcorn in regular brown bags or microwave safe glass bowls. * Exceed maximum time on popcorn package.
Baby food	<ul style="list-style-type: none"> * Transfer baby food to small dish and heat carefully, stirring often. Check for suitable temperature to prevent burns. * Remove the screw cap and nipple before warming baby bottles. After warming shake thoroughly. Check for suitable temperature. 	<ul style="list-style-type: none"> * Heat disposable bottles. * Overheat baby bottles. Only heat until warm. * Heat bottles with nipples on. * Heat baby food in original jars.
General	<ul style="list-style-type: none"> * Food with filling should be cut after heating, to release steam and avoid burns. * Use a deep bowl when cooking liquids or cereals to prevent boiling over. 	<ul style="list-style-type: none"> * Heat or cook in closed glass jars or airtight containers. * Deep fat fry. * Heat or dry wood, herbs, wet papers, clothes or flowers.
Liquids (Beverages)	<ul style="list-style-type: none"> * For boiling or cooking liquids see WARNING on page 1-2 to prevent explosion and delayed eruptive boiling. 	<ul style="list-style-type: none"> * Heat for longer than recommended time.
Canned foods	<ul style="list-style-type: none"> * Remove food from can. 	<ul style="list-style-type: none"> * Heat or cook food in cans.
Sausage rolls, Pies, Christmas pudding	<ul style="list-style-type: none"> * Cook for the recommended time. (These foods have high sugar and/or fat contents.) 	<ul style="list-style-type: none"> * Overcook as they may catch fire.
Meats	<ul style="list-style-type: none"> * Use a microwave proof roasting rack or plate to collect drained juices. 	<ul style="list-style-type: none"> * Place meat directly on the ceramic oven floor for cooking.
Utensils	<ul style="list-style-type: none"> * Check the utensils are suitable for MICROWAVE cooking before you use them. 	<ul style="list-style-type: none"> * Use metal utensils for MICROWAVE cooking. Metal reflects microwave energy and may cause an electrical discharge known as arcing.
Aluminium foil	<ul style="list-style-type: none"> * Use to shield food to prevent over cooking. * Watch for sparking. Reduce foil or keep clear of cavity walls. 	<ul style="list-style-type: none"> * Use too much. * Shield food close to cavity walls. Sparking can damage the oven.

COOKING GUIDES

- Advice for MICROWAVE -

Cooking Techniques	
Arrange food carefully	Place the thickest areas toward outside of dish.
Watch cooking time	Cook for the shortest amount of time indicated and add more time as needed. Overcooked food can smoke or ignite.
Cover food before cooking	Check recipe for suggestions: paper towel, microwave plastic wrap or a lid. Covers prevent spattering and help food to cook evenly and helps keep oven clean.
Shield food	Use small pieces of aluminium foil to cover thin areas of meat or poultry to avoid overcooking.
Stir food	Stir food from outside to centre of dish once or twice during cooking, if possible.
Turn food	Food such as chicken, hamburgers or steaks should be turned over once during cooking.
Rearrange food	Food such as meatballs need to be rearranged halfway through cooking from top to bottom and from the centre of the dish to the outside.
Allow standing time	After cooking ensure adequate standing time. Remove food from oven and stir if possible. Cover during standing time can allow the food to finish cooking completely.
Check for cooking result	Look for signs indicating that the cooking temperature has been reached. Good cooking results include: <ul style="list-style-type: none"> - Steam emits throughout the food, not just at edge; - Joints of poultry can be torn apart easily; - Pork and poultry show no pinkness; - Fish is opaque and flakes easily with a fork.
Condensation	A normal part of microwave cooking. The humidity and moisture in food will influence the amount of moisture in the oven. Generally, covered foods will not cause as much condensation as uncovered foods. Ensure that the ventilation openings are not blocked.
Microwave safe plastic wrap	For cooking food with high fat content, do not bring the wrap in contact with the food as it may melt.
Microwave safe plastic cookware	Some microwave safe plastic cookware is not suitable for cooking food with high fat and sugar content.
Cake/Meatloaf	For cooking cake or meatloaf, place the container on up-turned heat-resistant shallow dish.

- Advice for defrosting -

Defrosting Techniques	
Arrange	Arrange food in a single even layer in a shallow dish. This will ensure that all parts of the food defrosts evenly.
Separate	Food may be stuck together when removed from the freezer. It is important to separate foods as soon as possible during defrosting. e.g. steaks, chops
Stand	Standing time is necessary to ensure food is thoroughly defrosted. Food must stand, covered, for a length of time to ensure the centre has completely defrosted.

NOTE:

- Remove all packing and wrapping before defrosting.

AUTOMATIC COOKING CHART

SuperSteam Convection Menu Guide

RECIPES FOR COMPLETE MEALS

Salmon Steaks with Spinach and Potato Bake

[Utensils]

Large Shallow Casserole dish
2 Baking trays
Rack

[Ingredients for the Salmon Steak]

4 Salmon Steaks (Approx. 200 g each)
Juice of 1 Lemon
Black Pepper to taste

[Ingredients for the Spinach Bake]

Olive Oil to grease the dish
400g Defrosted Spinach, well drained
Salt and Pepper to taste
Nutmeg to season
500g Cooked Potatoes, peeled and sliced
150g Crème Fraîche
100ml Milk

Serves 4

[Method]

1. Wash and dry the salmon steaks. Sprinkle with lemon juice and salt, if desired. Season with black pepper.
2. Place the salmon steaks on rack in baking tray. Place the baking tray on upper position.
3. Lightly grease the large shallow casserole dish. Season the spinach leaves with salt and pepper and mix well.
4. Spread $\frac{1}{2}$ of the spinach covering the base of the large shallow casserole dish, followed by layering $\frac{1}{2}$ of the potato slices. Continue the next layer by spreading the remaining spinach, followed by layering the remaining potato slices.
5. Mix the Crème fraîche with the milk, season with salt and pepper and pour over the vegetables. Season with nutmeg.
6. Place the large shallow casserole dish on another baking tray. Place the baking tray on lower position.
7. Cook using 'SuperSteam Convection, AUTO, COMPLETE MEALS, SALMON STEAKS WITH POTATO BAKE'.
8. After cooking, stand covered with aluminium foil for 5 minutes.

Chicken Breasts with Mediterranean Style Roasted Vegetables

[Utensils]

1 Baking tray
Rack

[Ingredients for Chicken]

3 tbsp Soy Sauce
3 tbsp White Wine
2 cloves Garlic, crushed
Black Pepper to taste
4 Chicken Breasts
(Approx. 200g each)
4 tbsp Corn flour

[Ingredients for the Mediterranean
roasted vegetables]

75g Asparagus
1 tbsp Olive Oil
Salt and Pepper to taste
1 tsp Fresh Rosemary
200g Potatoes, cubed 2cm
1 Onion, sliced
100g Tomatoes, quartered
100g Eggplant, sliced
1 Yellow Capsicum, sliced

Serves 4

[Method]

1. In a large bowl, mix together the soy sauce, wine, garlic and black pepper.
2. Add the chicken and marinate for 1 hour.
3. Add the corn flour and mix together until the chicken pieces are completely coated.
4. Trim the hard bottom of the asparagus and cut into 3 equal amounts of approx. 4 cm length.
5. In a large bowl, combine the olive oil, salt, pepper and rosemary. Add all vegetables and mix well
6. Place the vegetables directly into a baking tray, towards the right.
7. Place the chicken on the rack, towards the left, place rack into the baking tray. Place the baking tray on upper position.
8. Cook using 'SuperSteam Convection, AUTO, COMPLETE MEALS, CHICKEN BREAST WITH ROASTED VEG'.
9. After cooking, stand covered with aluminium foil for 5 minutes.

AUTOMATIC COOKING CHART

Chinese Style Beef with Noodles

[Utensils]

Large Shallow Casserole dish
Small shallow Casserole Dish
2 Baking trays

[Ingredients]

400g Beef Rump Steak
1 tbsp Light Soy Sauce
1 tbsp White Wine
1/2 tsp Sugar
1 tsp Sesame Oil
2 tsp Corn flour
1 tbsp Ginger, grated
1 tbsp Oyster Sauce
1.5 tbsp Garlic, crushed
1 Fresh Bird's Eye Chilli,
seeds removed, finely chopped
100 ml Hot Beef stock
3 tbsp Canned Black Beans, chopped
(or canned kidney beans)
1/2 Green Capsicum, sliced
1 Onion, chopped
5 Shallots, sliced
400g Fresh Egg Noodles
1 1/2 cups Cold Water

Serves 4

[Method]

1. Cut beef into strips.
2. In a large bowl, mix together the soy sauce, wine, sugar, sesame oil, corn flour, ginger, oyster sauce, garlic and chilli.
3. Add the hot beef stock to the mixture.
4. Add the black beans, capsicum, onion, shallots and steak. Mix well.
5. Pour the mixture into the large shallow casserole dish. Place the dish into the baking tray. Place the baking tray on upper position.
6. Put the noodles into the small casserole dish and cover with the cold water. Place the dish on another baking tray. Place the baking tray on lower position.
7. Cook using 'SuperSteam Convection, AUTO, COMPLETE MEALS, CHINESE BEEF WITH NOODLES'.
8. Drain the noodles. Stir the noodles and the beef immediately after cooking then stand for 5 minutes.

Roast Leg of Lamb with Roasted Potatoes, Carrots and Turnips

[Utensils]

Small shallow casserole dish
2 Baking trays

[Ingredients]

1kg Leg of Lamb with bone
1 tbsp Olive Oil
Salt and Pepper to taste
1 tbsp Fresh Rosemary
500g Baby Potatoes, cut in half
200g Carrot, diced
200g Turnips, diced
8 tbsp Cold Water

Serves 4

[Method]

1. Place the lamb directly in baking tray. Brush with olive oil and season with salt, pepper and rosemary. Place the baking tray on upper position.
2. Brush the potatoes with olive oil. Place in the left hand side of another baking tray.
3. Put the carrot and turnips into the small shallow casserole dish, add the cold water and cover with aluminium foil. Place the dish into the baking tray. Place the baking tray on lower position.
4. Cook using 'SuperSteam Convection, AUTO, COMPLETE MEALS, ROAST LEG OF LAMB WITH ROASTED VEG'.
5. Stand for 5 minutes after cooking.

Roast Beef with Potatoes

[Utensils]

1 Baking tray
Rack

[Ingredients]

1/4 cup chopped fresh parsley
1 tbsp chopped fresh coriander
1 tbsp chopped fresh chives
1/4 tsp cracked black pepper
salt and pepper to taste
oil to brush
1kg roast beef
800g baby potatoes

Serves 4-6

[Method]

1. Preheat is pre-programmed. Select the menu, desired cooking result and press **START** to preheat.
2. In a small bowl, combine the parsley, coriander and chives. Mix until well combined. Spread the herb mixture over a clean chopping board.
3. Evenly brush the beef with oil. Roll the beef over the herb mixture, coating evenly. Season with salt and pepper. Set aside.
4. Wash and cut the baby potatoes in half.
5. Place meat on the rack in baking tray. Evenly place the potatoes around the beef on the rack.
6. After preheating, place the baking tray on lower position.
7. Cook using 'SuperSteam Convection, AUTO, COMPLETE MEALS, ROAST BEEF WITH POTATOES'.
8. After cooking, stand covered with aluminium foil for 10-15 minutes.

AUTOMATIC COOKING CHART

Spinach and Ricotta Cannelloni

[Utensils]

Large shallow casserole dish
1 Baking tray

[Ingredients]

250g packet frozen spinach, thawed
500g reduced fat ricotta cheese
pinch of ground nutmeg
salt and pepper to taste
12 instant cannelloni tubes
500g jar tomato basil pasta sauce
2 tbsps shredded cheddar cheese

Serves 4

[Method]

1. Drain spinach and squeeze to remove any excess liquid.
2. In a large bowl, add the spinach, ricotta cheese, nutmeg, salt and pepper. Mix until well combined.
3. Place mixture into a piping bag. Fill the cannelloni tubes by gently squeezing the piping bag until each tube is filled. Place the tubes in a single layer in a large shallow casserole dish.
4. Pour the pasta sauce over the cannelloni. Smooth the sauce over the pasta using the back of a spoon to ensure even coverage.
5. Sprinkle the cheddar cheese over the pasta.
6. Place casserole dish on a baking tray. Place the baking tray on upper position.
7. Cook using 'SuperSteam Convection, AUTO, COMPLETE MEALS, SPINACH AND RICOTTA CANNELLONI'.
8. After cooking, stand for 5 minutes.

Vegetable Rice with Prawns

[Utensils]

1 Baking tray

[Ingredients]

1 carrot, grated
100g green beans, sliced
1/2 leek sliced, cut into quarters
125g can corn kernels
2 1/2 cups water
1 tsp vegetable powder
2 cups jasmine rice, rinsed
150g cooked peeled prawns, cut into small pieces
salt and pepper to taste

Serves 4

[Method]

1. In a large bowl, combine carrot, beans, leek and corn. Add water and vegetable stock. Mix until well combined.
2. Continue to add the rice, prawns, salt and pepper. Mix until well combined.
3. Carefully pour this mixture into a baking tray and evenly spread. Place the baking tray on upper position.
4. Cook using 'SuperSteam Convection, AUTO, COMPLETE MEALS, VEGETABLE RICE WITH PRAWNS'.
5. After cooking, stand for 5 minutes.

Roast Chicken with Potatoes and Parsnips

[Utensils]

1 Baking tray
Rack

[Ingredients]

1tbsp oil
1/2 tsp chicken stock
1/2 tsp dried oregano
salt and pepper to taste
1 kg chicken
500g baby potatoes
300g parsnips

Serves 4

[Method]

1. Preheat is pre-programmed. Select the menu, desired cooking result and press **START** to preheat.
2. In a small bowl, combine the oil, chicken stock, oregano, salt and pepper. Mix until well combined.
3. Evenly brush chicken with oil mixture. Tie the chicken legs together. Set aside.
4. Wash baby potatoes and parsnips. Cut potatoes in half, and cut parsnips into quarters.
5. Place chicken breast side up on the rack in baking tray. Evenly place the potatoes and parsnips around the chicken on the rack.
6. After preheating, place the baking tray on upper position.
7. Cook using 'SuperSteam Convection, AUTO, COMPLETE MEALS, ROAST CHICKEN WITH POTATOES'.
8. After cooking, stand covered with aluminium foil for 10 minutes.

AUTOMATIC COOKING CHART

SUPERSTEAM GRILL

Menu name	Weight range (Increasing unit)	Procedure	Baking Tray Position
Chicken Legs (initial temp 5°C)	0.2 - 1.0 kg (100g)	<ul style="list-style-type: none"> Season with salt, pepper and paprika. Pierce the skin of the chicken legs. Put the chicken legs on the rack, skin side down, in baking tray. After cooking, place on a dish and serve. 	Upper
Chicken Fillet (initial temp 5°C)	0.25 - 1.00 kg (50g)	<ul style="list-style-type: none"> Season with salt, pepper and paprika. Put the chicken fillet on the rack in baking tray. After cooking, stand for 5 minutes. 	Upper
Grilled Fish (initial temp 5°C)	0.2 - 1.0 kg (100g) whole fish	<ul style="list-style-type: none"> Make a few slits on the skin of fish. Brush oil, then pat with cornstarch lightly on fish body. Place fish on rack in baking tray and put in the oven. After cooking, place on a dish and serve. 	Upper
Grilled Skewers (initial temp 5°C)	0.20 - 0.80 kg (50g)	<ul style="list-style-type: none"> Prepare the grill skewers referring to the recipe below. Place on the rack in baking tray. After cooking, remove and put on a plate for serving. 	Upper

RECIPES FOR GRILLED SKEWERS

Pork Kebabs

[Ingredients]

400g escalope of pork
 100g smoked belly of pork
 2 onions (100 g), in quarters
 4 tomatoes (250 g), in quarters
 1/2 green pepper (100 g), in eight pieces
 4 tbsp oil
 2 tsp sweet paprika
 salt
 1/2 tsp cayenne pepper
 1 tsp worcester sauce

[Method]

1. Cut the escalope of pork and the pork belly into 2-3 cm cubes.
2. Thread meat and vegetables alternately on four wooden skewers (approx. 25cm long).
3. Combine the oil with the spices and brush over the kebabs. Place the kebabs on the rack in baking tray.
4. Cook using 'SuperSteam Convection, AUTO, GRILL, GRILLED SKEWERS'.

AUTOMATIC COOKING CHART

SUPERSTEAM ROAST

Menu name	Weight range (Increasing unit)	Procedure	Baking Tray Position
Roast Chicken (initial temp 5°C)	0.9 - 2.0 kg (100g)	<ul style="list-style-type: none"> Season with salt, pepper and paprika. Place on rack in baking tray, uncovered and cook. After cooking, stand covered with aluminium foil for 10 minutes. 	Lower
Roast Pork (initial temp 5°C)	0.9 - 1.5 kg (100g)	<ul style="list-style-type: none"> Tie meat with string (loins only). Season with salt, pepper and paprika. Place on rack in baking tray, uncovered and cook. After cooking, stand covered with aluminium foil for 10 minutes. 	Lower
Roast Beef, Medium (initial temp 5°C)	1.0 - 2.0 kg (100g)	<ul style="list-style-type: none"> Season with salt and pepper. Place meat on rack in baking tray, uncovered and cook. After cooking, stand covered with aluminium foil for 5 - 10 minutes. 	Lower
Roast Leg of Lamb (initial temp 5°C)	1.0 - 2.0 kg (100g)	<ul style="list-style-type: none"> Season with salt, pepper and rosemary. Place on rack in baking tray, uncovered and cook. After cooking, stand covered with aluminium foil for 10 minutes. 	Lower

SUPERSTEAM BAKE

Menu name	Weight range (Increasing unit)	Procedure	Baking Tray Position
Frozen Pizza (Thin, Thick Type) (initial temp -18°C)	1 layer cooking: 0.2 - 1.0 kg (100 g) 2 layers cooking: 0.2 - 1.0 kg (100 g)	<ul style="list-style-type: none"> Preheat is pre-programmed. Select the menu, desired layer, quantity and cooking result, then press START to preheat. Remove from packaging and place on the baking tray. After preheating, put the baking tray in the oven. After cooking, serve. 	1 layer cooking: Upper 2 layers cooking: Upper/Lower
Cake (initial temp 20°C) eg: Carrot Cake, Butter Cake, Chocolate Cake	1 layer (Cake tin: approx. 20cm)	<ul style="list-style-type: none"> Use desired homemade recipe or packet mix. Preheat is pre-programmed. Select the menu, desired cooking time and press START to preheat. After preheating, place the cake tin on the baking tray. Put the baking tray in the oven. After baking, allow to cool in the cake tin for 5 minutes. 	Lower
Bread (initial temp 20°C) eg: White Loaf, Multigrain Loaf	1 layer (Loaf tin: approx. 13 x 20cm)	<ul style="list-style-type: none"> Use desired homemade recipe or packet mix. Preheat is pre-programmed. Select the menu, desired cooking time and press START to preheat. After preheating, place the loaf tin on the baking tray. Put the baking tray in the oven. After baking, allow to cool in the loaf tin for 5 minutes. 	Lower
Baked Potatoes (initial temp 20°C)	1 - 4 piece (1 piece: 250g)	<ul style="list-style-type: none"> Preheat is pre-programmed. Select the menu, quantity, desired cooking time and press START to preheat. Pierce each potato in several places and place on rack in baking tray. After preheating, put the baking tray in the oven. After cooking, leave to stand wrapped in aluminium foil for 2 - 3 minutes. 	Lower

AUTOMATIC COOKING CHART

Steam Menu Guide

Menu name	Weight range (Increasing unit)	Procedure	Baking Tray Position															
Fresh Vegetable 1 (initial temp 20°C) Soft Vegetables: Zucchini, Capsicum, Broccoli, Mushrooms, Asparagus	0.2 - 1.0 kg (100g)	<ul style="list-style-type: none"> Wash vegetables, then remove excess water. Put vegetables in a steam tray. Place the steam tray on rack in baking tray, uncovered. After cooking, stand for 1 - 5 minutes. 	Upper															
Fresh Vegetable 2 (initial temp 20°C) Hard Vegetables: Carrots, Cauliflower, Beans, Brussels Sprouts	0.2 - 1.0 kg (100g)																	
Frozen Vegetable (initial temp -18°C) Mixed Vegetables, Broccoli, Peas, Carrots, Cauliflower	0.2 - 1.0 kg (100g)	<ul style="list-style-type: none"> Put frozen vegetables in a steam tray. Place the steam tray on rack in baking tray, uncovered. After cooking, stand for 1 - 5 minutes. 	Upper															
Fresh Fish/ Fresh Prawns (initial temp 5°C) Whole Snapper, Barramundi Fillet, Large Green Prawns	0.1 - 1.0 kg (100g)	<ul style="list-style-type: none"> Wash fish thoroughly and remove scales. Make a few slits on the skin of fish, pierce the eyes of fish. Put fish/prawns in a steam tray. Place the steam tray on rack in baking tray, uncovered. After cooking, stand for 1 - 3 minutes. 	Upper															
Frozen Convenience (Dumplings) (initial temp -18°C) Vegetable, Pork, Chicken	0.1 - 0.5 kg (100g)	<ul style="list-style-type: none"> Put food in a steam tray. Place the steam tray on rack in baking tray, uncovered. After cooking, stand for 1 - 3 minutes. 	Upper															
Rice (initial temp 60°C hot tap water or soup stock) White Rice	1 - 4 serves (1 serve)	<ul style="list-style-type: none"> Wash rice thoroughly until water runs clear. Place into 2 litre shallow casserole dish and cover with hot soup stock or with hot tap water. Place the dish on baking tray, uncovered. After cooking, stand for 1 - 5 minutes. <table border="1" style="margin-left: auto; margin-right: auto;"> <thead> <tr> <th>Serve</th> <th>1 serve</th> <th>2 serves</th> <th>3 serves</th> <th>4 serves</th> </tr> </thead> <tbody> <tr> <td>Rice</td> <td>1/2 cup</td> <td>1 cup</td> <td>1 1/2 cups</td> <td>2 cups</td> </tr> <tr> <td>Soup stock or Hot tap water</td> <td>1 1/2 cups</td> <td>2 1/2 cups</td> <td>3 cups</td> <td>4 cups</td> </tr> </tbody> </table>	Serve	1 serve	2 serves	3 serves	4 serves	Rice	1/2 cup	1 cup	1 1/2 cups	2 cups	Soup stock or Hot tap water	1 1/2 cups	2 1/2 cups	3 cups	4 cups	Upper
Serve	1 serve	2 serves	3 serves	4 serves														
Rice	1/2 cup	1 cup	1 1/2 cups	2 cups														
Soup stock or Hot tap water	1 1/2 cups	2 1/2 cups	3 cups	4 cups														

SHARP

SHARP CORPORATION

Printed in Thailand

TINS-A779WRRZ-J92



Australia's largest online appliance retailer