

**DeLonghi**

**De'Longhi Outdoor Cooking Centre  
Models DELUX9FS21/DELUX9FS21NG**

**Assembly and Operating Instructions**



**For Outdoor Use Only**

**DeLonghi**

De'Longhi Australia Pty Limited  
P.O. Box 4156 Milperra BC,  
NSW, AUSTRALIA 1891.  
Phone: 1800 126 659  
[www.delonghi.com.au](http://www.delonghi.com.au)

De'Longhi New Zealand Limited  
P.O. Box 58056 Greenmount,  
Auckland, NEW ZEALAND.  
Phone: 0508 200 300  
[www.delonghi.co.nz](http://www.delonghi.co.nz)

 **appliancesonline**  
Australia's largest online appliance

**WARNING:** Read this Owner's Manual carefully and be sure your Outdoor Cooking Centre has been properly assembled, installed and maintained. Failure to follow these instructions could result in serious bodily injury and/or property damage.

DO NOT use this Outdoor Cooking Centre indoors. This Outdoor Cooking Centre is intended for outdoor use only and is not intended to be installed in or on recreational vehicles or boats.

**IMPORTANT NOTE:** READ ALL INSTRUCTIONS PRIOR TO ASSEMBLY AND USE!

REMOVE ALL TRANSIT PROTECTION FITTED TO THE OUTDOOR COOKING CENTRE BEFORE USE.

Nuts and Bolts may become loose during transit, so for your own safety, thoroughly inspect every nut and bolt and secure as necessary before using your new Outdoor Cooking Centre.

The instruction manual should be retained for future reference.

## Table of Contents

For Your Safety	2
Warnings	3
Use Outdoors Only	4
Exploded Drawing	5
Parts List	6
Assembly Instruction	8
Checking for LPG Leaks	13
Basic Grill Lighting Instructions	14
Smoker Burner Lighting Instructions	16
Side Burner Lighting Instructions	17
Rotisserie Assembly	18
Using the Rotisserie & Infrared Back Burner	19
Using The Smoker Drawer	20
Natural Gas Installation	21
Accessories	22
Troubleshooting	22
Cleaning and Maintenance	23
Cooking Instructions	25
Technical Specifications	26
Warranty	27
Customer Service & Spare Parts	27

## For Your Safety

1. Do not store or use gasoline or other flammable vapours and liquids in the vicinity of this or any other appliance.
2. Do not store an LPG cylinder not connected for use in the vicinity of this or any other appliance.

**If you smell gas:**

1. Shut off gas to the appliance.
2. Extinguish any open flame.
3. Open lid.
4. If odour continues, immediately call your gas supplier or your fire department.



## Warranty

### 2 Years Full Warranty

Thank you for purchasing this De'Longhi product. Your product is warranted against faults and manufacture when used in normal use for the period of two years. In non domestic use De'Longhi limits the voluntary warranty to 6 months.

We undertake to repair or replace your product at no charge if found to be defective due to a manufacturing fault during the warranty period of two years. The warranty excludes damage caused by misuse, neglect, shipping accident, incorrect installation, no fault found with the product or work carried out by anyone other than an Authorised De'Longhi Service Representative.

PLEASE KEEP YOUR RECEIPT TO AUTHENTICATE YOUR WARRANTY.

## Customer Service & Spare Parts

If your Outdoor Cooking Centre needs part(s) replacement or repair part(s), please contact De'Longhi Customer Service in your region. To ensure prompt and accurate service, please provide the following information when placing a repair part order: model number, serial number, part name, part number, and quantity of parts needed.

**IMPORTANT:** Keep this Owner's Manual for convenient referral and for part(s) replacement.

**IMPORTANT:** Use only factory authorized parts. The use of any part that is not factory authorized can be dangerous. This will also void your warranty.

To talk to a De'Longhi representative for further information, please call the number in your region shown below.

De'Longhi Australia Pty Limited  
P.O. Box 4156 Milperra BC,  
NSW, AUSTRALIA 1891.  
Phone: 1800 126 659  
[www.delonghi.com.au](http://www.delonghi.com.au)

De'Longhi New Zealand Limited  
P.O. Box 58056 Greenmount,  
Auckland, NEW ZEALAND.  
Phone: 0508 200 300  
[www.delonghi.co.nz](http://www.delonghi.co.nz)

## Technical Specifications

Model: DELUX9FS21		Gas Type: Universal LPG		AGA Approval No.: 6960	
Burner Type	Injector (mm)	Test Point Pressure (kPa)	Turndown Gas Consumption (Mj/h)	Nominal Gas Consumption (Mj/h)	
Main Burner (×6)	0.95	2.75	5.8	11.5	
Smoker Burner (×1)	0.67	2.75	-	5.7	
Rotisserie Burner (×1)	0.95	2.75	-	11.0	
Side Burner (×1)	0.95	2.75	9.5	12.0	
<b>TOTAL</b>				<b>97.7</b>	

Model: DELUX9FS21NG		Gas Type: Natural Gas		AGA Approval No.: 6960	
Burner Type	Injector (mm)	Test Point Pressure (kPa)	Turndown Gas Consumption (Mj/h)	Nominal Gas Consumption (Mj/h)	
Main Burner (×6)	1.60	1.00	5.8	12.0	
Smoker Burner (×1)	1.09	1.00	-	5.7	
Rotisserie Burner (×1)	1.60	1.00	-	11.5	
Side Burner (×1)	1.70	1.00	10.3	15.0	
<b>TOTAL</b>				<b>104.2</b>	

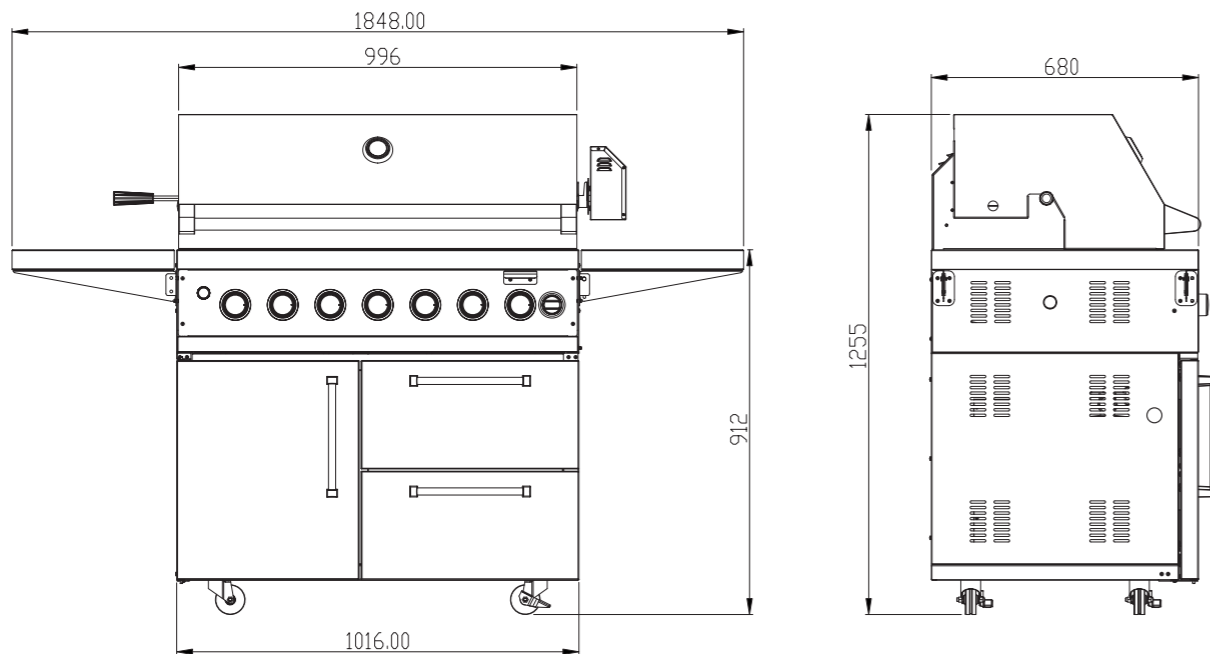

## Warnings

Failure to comply with these instructions could result in a fire or explosion that could cause serious bodily injury, death, or property damage.

Your Outdoor Cooking Centre will get very hot. Never lean over the cooking area while using your Outdoor Cooking Centre. Do not touch cooking surfaces, grill housing, hood or any other parts while the Outdoor Cooking Centre is in operation, or until the Outdoor Cooking Centre has cooled down after use.

### Outdoor Cooking Centre Installation Codes

This Outdoor Cooking Centre must be installed in accordance with all local codes.

### Correct LPG Cylinder Use

The Outdoor Cooking Centre is designed for use with up to a 9kg Liquid Propane Gas (LPG) cylinder, not included with the Outdoor Cooking Centre. Never connect your Outdoor Cooking Centre to an LPG cylinder that exceeds this capacity. The LPG cylinder to be used must be constructed and marked in accordance with the Specifications for LP-gas Cylinders of the Australian Standard AS2030. Consult your local gas dealer to obtain the correct gas cylinder.

### Proper Placement and Clearance of your Outdoor Cooking Centre

Never use your Outdoor Cooking Centre in a garage, porch, shed, breezeway or any other enclosed area. Your Outdoor Cooking Centre is to be used outdoors only, allow a minimum clearance around the Outdoor Cooking Centre of 460mm from sides, 600mm from rear and 1000mm overhead to any combustible surface. Your Outdoor Cooking Centre should not be placed under any surface that will burn. Do not obstruct the flow of ventilation air around the Outdoor Cooking Centre.

### GENERAL WARNINGS

- The Outdoor Cooking Centre is not intended to be installed in or on recreational vehicles and/or boats.
- Never connect an unregulated LPG cylinder to your Outdoor Cooking Centre. The gas Regulator assembly supplied with your Outdoor Cooking Centre is adjusted to have an outlet pressure of 2.75kPa for connection to an LPG cylinder.
- Only use the Regulator and Hose Assembly supplied with your Outdoor Cooking Centre. Replacement Regulators and Hose Assemblies must be those specified by manufacturer.
- Have your LPG cylinder filled by a reputable propane gas dealer; visually inspected at each filling.
- Have your propane gas dealer check the release valve after every filling to ensure that it remains free of defects.
- Always keep LPG cylinders in an upright position.
- Do not store (or use) gasoline or other flammable vapours and liquids in the vicinity of this Outdoor Cooking Centre.
- An LPG cylinder that is not connected for use must NOT be stored inside the cabinet or in the vicinity of this or any other gas appliance.
- Do not subject the LPG cylinder to excessive heat.
- Never store an LPG cylinder indoors. If you store your Outdoor Cooking Centre in the garage or other indoor location, always disconnect the LPG cylinder first and store it safely outside.
- When your Outdoor Cooking Centre is not in use the gas must be turned off at the LPG cylinder valve.
- The Regulator and Hose Assembly must be inspected before each use of the Outdoor Cooking Centre. If there is excess abrasion or wear, or if the hose is cut, it must be replaced prior to the Outdoor Cooking Centre being used again.
- Keep the gas Regulator Hose away from hot surfaces and dripping grease.
- Avoid unnecessary twisting of hose. Visually inspect the Regulator and Hose prior to each use for cuts, cracks, excessive wear or other damage. If the Hose appears damaged do not use the Outdoor Cooking Centre.
- Never light your Outdoor Cooking Centre with the Hood closed or before checking to insure the Burner Tubes are fully seated over the gas valve nozzle.
- Never allow children to operate your Outdoor Cooking Centre. Do not allow children to play near the Outdoor Cooking Centre.
- LPG cylinders must be stored outdoors out of the reach of children and must not be stored in a building, garage or any other enclosed area.
- **ALWAYS** use an Open Grill over the Smoker burner on the right hand side of your Outdoor Cooking Centre.

## Use Outdoors Only

This appliance shall only be used in an above ground open-air situation with natural ventilation, without stagnant areas, where gas leakage and products of combustion are rapidly dispersed by wind and natural convection.

Any outdoor enclosure in which the appliance is used shall comply with one of the following:

- An enclosure with walls on all sides, but at least one permanent opening at ground level and no overhead cover. See Figure 1.
- Within a partial enclosure that includes an overhead cover and no more than two walls. See Figure 2 & 3.
- Within a partial enclosure that includes an overhead cover and more than two walls, the following shall apply:
  - At least 25% of the total wall area is completely open; and
  - At least 30% of the remaining wall area is open and unrestricted. See Figure 4 & 5.
- In the case of balconies, at least 20% of the total of the side, back and front wall areas shall be and remain open and unrestricted.

The following diagrams provide a diagrammatic representation of outdoor areas. Rectangular areas have been used in these figures - the same principles apply to any other shaped area.

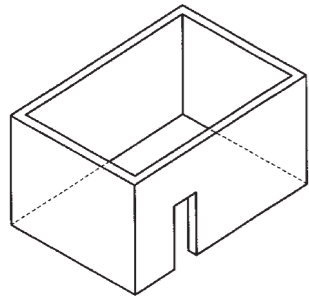

Figure 1 - Enclosure with walls on all sides but no overhead cover.

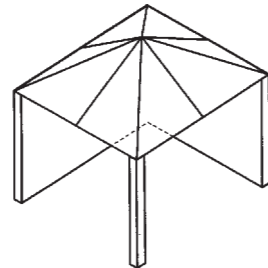
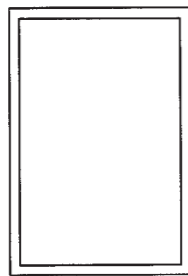

Figure 2 - Partial Enclosure with overhead cover and no more than two walls.

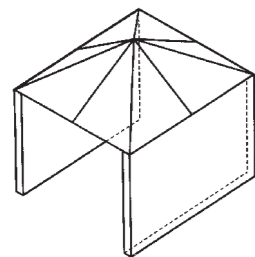
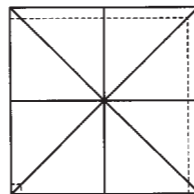

Figure 3 - Partial Enclosure with overhead cover and no more than two walls.

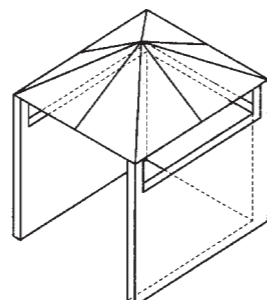
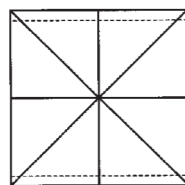

Figure 4 - Open side at least 25% of total wall area. 30% or more in total of the remaining wall area is open and unrestricted.

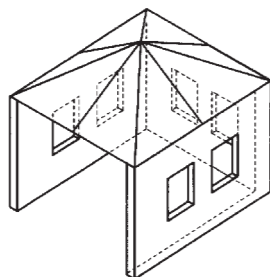
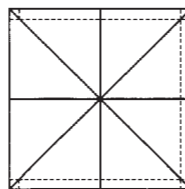

Figure 5 - Open side at least 25% of total wall area. 30 percent or more in total of the remaining wall area is open and unrestricted.

## Cooking Instructions

**WARNING:** Your Outdoor Cooking Centre will get very hot. Never lean over the cooking area during use. Do not touch cooking surfaces, burner housing, hood or any other parts while the Outdoor Cooking Centre is in operation, or until the Outdoor Cooking Centre has cooled down after use. Failure to comply with these instructions may result in serious bodily injury.

### Burn-off

Before cooking on your Outdoor Cooking Centre for the first time, you will want to "burn off" the Outdoor Cooking Centre to eliminate any odour or foreign matter. Follow the lighting instructions on Page 12 to ignite the Burners, lower the hood, and operate on the HIGH setting for three to five minutes.

**CAUTION:** If the burners fail to light, turn the control knob to OFF, wait 5 minutes till the gas clears and try again. Do not leave your Outdoor Cooking Centre unattended.

### Preheating

To preheat, light your Outdoor Cooking Centre on HIGH, lower the Hood and follow this timetable:

- For high temperature cooking, preheat Burners for 5 to 10 minutes.
- For low temperature cooking, preheat Burners for 3 minutes.
- To slow cook, preheating is not necessary.

### Cooking Temperatures

High setting: Only use this setting for fast warm-up, searing steaks or chops and for burning food residue off the grill after cooking is complete. Never use the HIGH setting for extended cooking.

Medium to Low settings: Most recipes specify medium to low settings, including all smoking, rotisserie cooking and for cooking lean cuts such as fish.

NOTE: Temperature settings will vary with the amount of wind and temperature outside your home.

### Direct Cooking

The direct cooking method can be used with the supplied Solid Plate & Open Grills and food placed directly over the lit grill Burners. Direct cooking requires the hood to be up. This method is ideal for searing and whenever you want meat, poultry or fish to have an open-flame barbecued taste. Smoking is also best cooked in this manner because it requires direct heat.

### Indirect Cooking

The indirect cooking method can also be used with the supplied Solid Plate & Open Grills. To cook indirectly, the food should be placed on the left or right side of your Outdoor Cooking Centre with the Burner lit on the opposite side. Or place your food on the Secondary Cooking Rack mounted inside your hood and light the outer grill Burners. Either way, indirect cooking must be done with the Hood down.



### Coating your Solid Plate & Open Grills

Before and after each cookout, apply a thin layer of cooking oil, spray or vegetable shortening to each Solid Plate & Open Grills. Be sure to coat the entire surface including edges. This will help prevent foods from sticking to your Solid Plate & Open Grills.

### Flare-ups

The fats and juices dripping from grilled food can cause flare-ups. Since flare-ups impart a favourably, distinctive taste and colour to food cooked over an open flame, they should be accepted up to a point. Nevertheless, uncontrolled flaring can result in a ruined meal.

**WARNING:** Do not line the bottom of the Burner housing with aluminum foil, sand or any substance that will restrict the flow of grease into the Grease Spillage Tray.

Failure to comply with these instructions could result in a fire or explosion, which could cause serious bodily injury, death, or property damage.

## Cleaning and Maintenance cont'd

### Cleaning the Burner Tubes and Burner Ports

To reduce the chance of "FLASH-BACK" the procedure below should be followed at least once a month in late summer or early fall when spiders are most active or when your Outdoor Cooking Centre has not been used for a period of time.

1. Turn all Control Knobs to the full OFF position.
2. Turn the LPG Cylinder Valve to the full OFF position (DELUX9FS21 model). For Natural Gas (DELUX9FS21NG model), turn off the gas supply at the manual shut-off valve.
3. Remove the Solid Plate & Open Grills, Flame Tamers, and Grease Spillage Tray.
4. Remove the screws at the front and rear of each Burner using a Screwdriver.
5. Carefully lift each Burner up and away from the Gas Valve Nozzle.
6. Perform one of these three cleaning methods:

- a) Bend a stiff wire, (a lightweight coat hanger works well) into a small hook as shown below. Run the hook through the Burner Tube and inside the Burner several times to remove any debris.

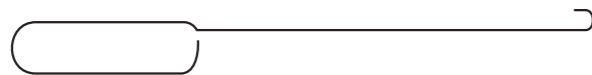

- b) Use a bottle brush with a flexible handle. Run the brush through the Burner Tube and inside the Burner several times, removing any debris.

- c) Use an air hose to force air through each Burner Tube. The forced air should pass debris or obstructions through the Burner and out the ports.

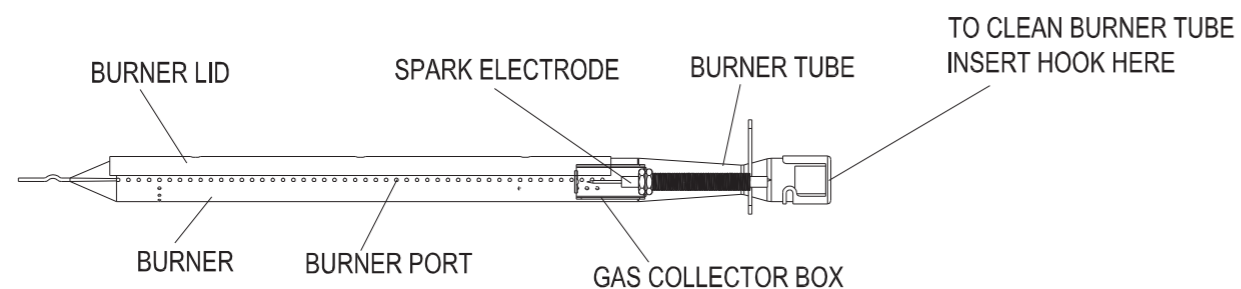

Regardless of which Burner cleaning procedure you use, we recommend you also complete the following steps to help prolong Burner life.

1. Use a brass wire brush to clean the entire outer surface of each Burner until free of food residue and dirt.
2. Clean any clogged ports with a stiff wire, such as an open paper clip.
3. Inspect each Burner for damage (cracks or holes) and if such damage is found, order and install a new Burner. After installation, check to insure that the Gas Valve Nozzle are correctly placed inside the ends of the Burner Tubes. Also check the position of your Spark Electrode.

**WARNING:** The location of the Burner Tube with respect to the Nozzle is vital for safe operation. Check to ensure the Orifice is inside of the Burner Tube before using your Outdoor Cooking Centre. See below. If the Burner Tube does not fit over the Nozzle, lighting the Burner may cause explosion and/or fire.

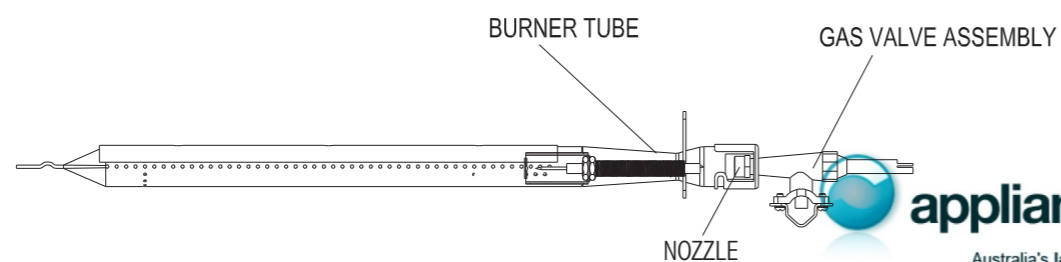

## Exploded Drawing

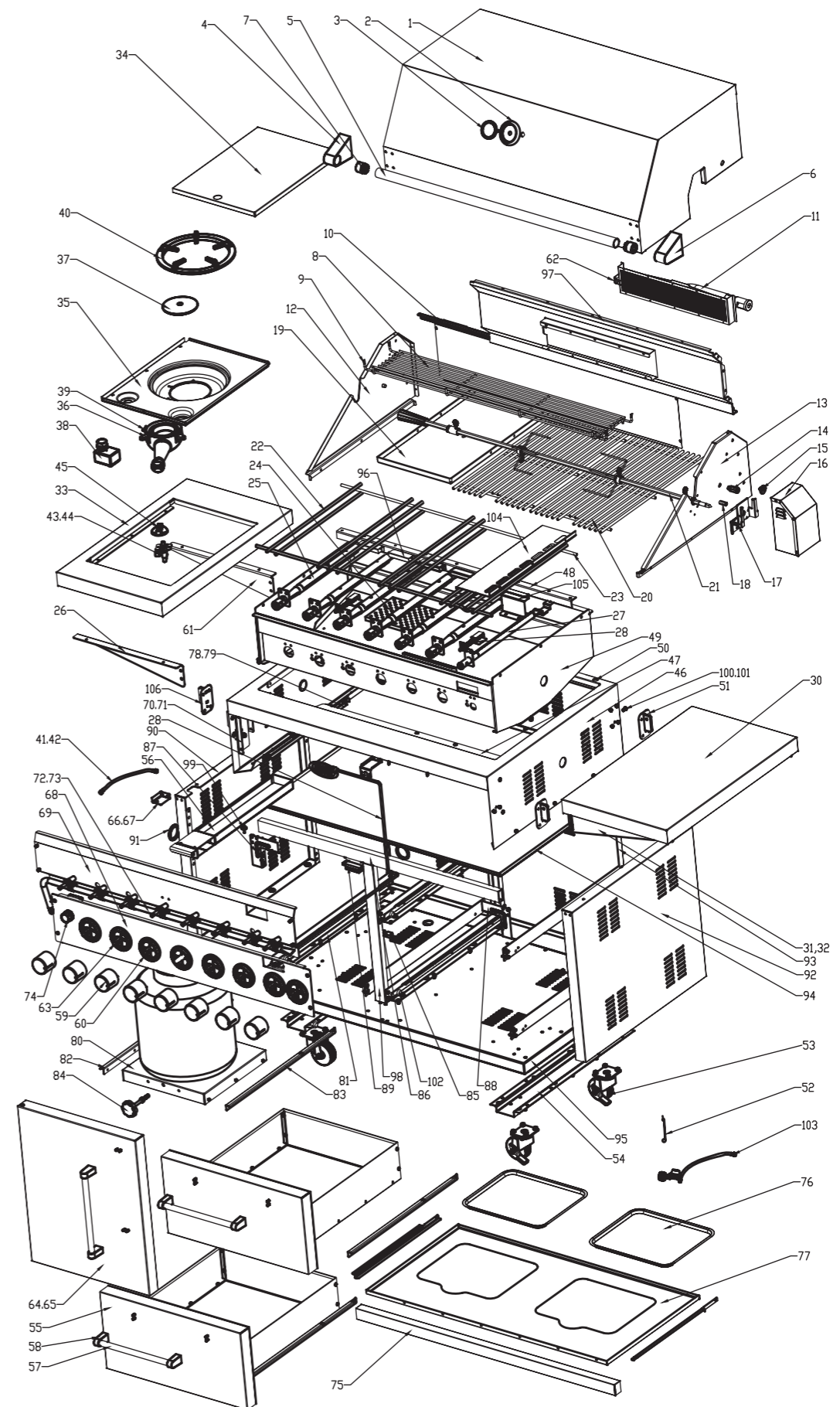

## Parts List

REF#	DESCRIPTION	PART#	QTY
1	Hood Assembly	142705/3000	1
2	Temperature Gauge Seat	142501/3008	1
3	Temperature Gauge	141601/306	1
4	Hood Handle Seat-Left	142801/2010	1
5	Hood handle	142901/2003	1
6	Hood Handle Seat-right	142801/2020	1
7	Heat-insulating Insert	141601/307	2
8	Warming Rack	142701/2201	1
9	Warming Rack Bracket	142501/2402	2
10	Rear Panel of Inner Hood	142701/2001	1
11	Infrared/Back Bumer	142501/2301	1
12	Left Panel of Inner Hood	142501/2001	1
13	Right Panel of Inner Hood	142501/2002	1
14	Shaft for Lid	142501/2005	2
15	Big Round Head Screw	*	2
16	Rotisserie Motor Kit	143905	1
17	Motor Bracket	142501/2006	1
18	Motor Support Tube	142806/2504	1
19	Solid Plate	142805/1005	1
20	Cooking Grid	142701/1005	2
21	Rotisserie Kit	142701/2100	1
22	Rack for Flame Tamers	142701/1008	1
23	Rack for Flame Tamers-R	142701/1004	1
24	Ceramic Flame Tamers	142501/1008	9
25	Main Burner Kit	142702/1200	6
26	Side Burner Shelf Bracket-F	142709/4202	1
27	Smoker Burner Kit	142701/1500	1
28	Electrode	142701/1800	3
29	Ripple Tube for Back Burner	142801/2305	1
30	Side Shelf	142501/4001	1
31	Side Shelf Bracket-F	142501/4002	2
32	Side Shelf Bracket-B	142501/4003	2
33	Side Burner Shelf	142709/4101	1
34	Side Burner Lid	142709/4003	1
35	Side Burner Tray	142709/4002	1
36	Side Burner Body&Venturi	146102/8101	1
37	Side Burner Head	146102/8102	1
38	Electronic Ignitor	141803/0004	1
39	Side Burner Electrode	146102/8004	1
40	Side Burner Pan Support	146102/8005	1
41	Manifold Inlet	142709/4004	1
42	Gas Connection Hose	142709/4001	1
43	Side Valve Assembly	142709/4300	1
44	Side Valve Assembly	142710/4300	1
45	Side Knob	141601/112	1
46	Body Frame	142701/1001	1
47	Heat Shield for Grease Tray	142701/1401	1
48	Burner Support	142702/1401	1
49	Burner Housing Assembly	142702/1100	1
50	Hole Collar	142501/1014	2
51	Side Shelf Bracket Kit	142501/4100	2
52	Match Holder	142501/1015	1
53	Castor with Brake	142501/5505	4
54	Support for Castor	142501/5504	2
55	Drawer Kit	142601/3400	2
56	Smoker Box Kit	142701/1600	1
57	Handle for Door&Drawer	142501/5103	3
58	Handle Seat for Door&Drawer	142501/5104	6
59	Knob	142801/1004	8
60	Knob Seat	142501/1013	8
61	Side Burner Shelf Bracket-B	142709/4203	1
62	Electrode for Back burner	141901/3307	1
63	Knob Inlay	141801/1008	8
64	Door Trim Plate	142601/3202	1
65	Door Panel	142601/3201	1
66	Door Hinge Bracket-Left Top	142501/5005	1
67	Door Hinge Bracket-Left Down	142501/5502	1
68	Control Panel	142705/1002	1
69	Heat Shield for Control Panel	142702/1003	1



## Cleaning and Maintenance

Keep outdoor cooking gas appliance area clear and free from combustible materials, gasoline and other flammable vapours and liquids. As with all appliances, proper care and maintenance will keep your Outdoor Cooking Centre in top operating condition and prolong its life. By following these cleaning procedures on a timely basis, your Outdoor Cooking Centre will stay clean and work properly with minimum effort.

**CAUTION:** Be sure your Outdoor Cooking Centre is OFF and cool before cleaning.

### Cleaning The Solid Plate & Open Grills

Before initial use and as needed, wash your Solid plate & Open grills with a mild detergent and rinse with hot water. For stubborn food residue use a degreaser and fibre or brass cleaning brush.

### Cleaning The Grease Spillage Tray

To reduce the chance of fire, the Grease Spillage Tray should be inspected before each use and if required, cleaned before turning the Outdoor Cooking Centre on. Remove grease (a plastic spatula works well) and wash Grease Spillage Tray with a mild soap and warm water solution.

### Cleaning the Flame Tamers

To reduce the chance of flare-ups, Flame Tamers should be cleaned whenever food or grease drippings accumulate. Brush off Flame Tamers with a fibre type brush and turn over to allow the Burner heat to burn off any stubborn food residue. The Ceramic Flame Tamers work equally well on either side.

### Annual Cleaning of The Outdoor Cooking Centre Interior

Use a fibre or brass cleaning brush to clean inside the Burner Housing, Solid Plate & Open Grills, Flame Tamers and Grease Spillage Tray. Never use a wire brush or metal scraper on porcelain finished parts (Open Grills) which can scratch or chip the porcelain finish and promote rusting.

1. Turn all Control Knobs to the full OFF position.
2. Shut off gas supply to your Outdoor Cooking Centre.
3. Remove and clean the Flame Tamers, Solid Plate, Open Grills, and Grill Burners.
4. Cover each Gas Valve Nozzle with aluminum foil.
5. Brush the inside and bottom of the Outdoor Cooking Centre with a brass wire brush or fibre cleaning pad, and wash with a mild soap and warm water solution. Rinse thoroughly and let dry.
6. Remove aluminum foil from Nozzles and check each Nozzle for obstruction.
7. Check each Spark Electrode, adjusting as needed. The space between the Spark Electrode Tip and Spark Receiver should be approximately 5mm.
8. Replace the Burners and adjust the Gas Collector Box. The edge of the collector box should be overlapping the Burner Port.
9. Replace Flame Tamers and the Solid Plate & Open Grills.
10. Reconnect the gas source and observe the Burner flame for correct operation.

### Exterior Stainless Steel Surfaces:

Weathering and high heat can cause the stainless steel hood to turn tan in colour. This is not to be confused with rust and is not a product defect. Machine oils used in the manufacturing process of stainless steel as well as cooking oils and a dirty hood can also encourage discolouration if the hood is not cleaned prior to use.

1. Shut off gas supply at source and disconnect fuel line from LPG cylinder. Protect fuel line fitting.
2. Use a Stainless Steel Cleaner and soft cloth to remove residual adhesive and oils from the inside and outside of the Hood. Never use abrasive cleaners or scrubbers. In addition to the initial cleaning, routine cleaning to remove dirt, grease and oils will help discourage hood discolouration.

### CAUTION: BEWARE OF FLASH-BACK

Spiders and small insects occasionally spin webs or make nests in the grill Burner Tubes during transit and warehousing. These webs can lead to a gas flow obstruction, which could result in a fire in and around the Burner Tubes. This type of fire is known as a "FLASH-BACK" and can cause serious damage to your Outdoor Cooking Centre and create an unsafe operating condition for the user.

Although an obstructed Burner Tube is not the only cause of "FLASH-BACK", you must clean the Burner Tubes before assembling your Outdoor Cooking Centre, and at least once a month in late summer or early fall when spiders are most active. Also perform this Burner Tube cleaning procedure if your Outdoor Cooking Centre has not been used for an extended period of time.

## Accessories

### WEATHERPROOF COVER



Part No. - DELUX6FSCOVER

### 10 PIECE BBQ TOOL SET



Part No. - OCCTOOLSET

### STAINLESS STEEL WIRE RACKS



Part No. - SSWIREDELUX6

### DOUBLE SIZE STAINLESS STEEL TEPPANYAKI PLATE\*



Part No. - SSPLDELUX6DBL

### SINGLE STAINLESS STEEL TEPPANYAKI PLATE\*



Part No. - SSPLATEDELUX6

### CERAMIC FLAME TAMERS - FULL REPLACEMENT SET



Part No. - FTSETDELUX6 (9 pcs in set)

\* **WARNING** - NEVER cover the entire cooking surface with solid plates. Always use an Open Grill over the Smoker Burner on the right hand side of your Outdoor Cooking Centre.

For your Safety, **DO NOT** place solid plates over the entire cooking surface as it will cause overheating.

## Troubleshooting

**Problem:** Misalignment of Burner Tubes over Nozzles

**Correction:** Reposition Burner Tubes over Nozzles.

**Problem:** Obstruction in gas line

**Correction:** Follow procedure on Page 13 to purge the line. If problem persists, please call De'Longhi Customer Service for assistance on 1800 126 659 during business hours.

**Problem:** Blocked Nozzle

**Correction:** Remove Burners by removing screws (the rear and the front of Burner) using a screwdriver. Carefully lift each Burner up and away from Gas Valve Nozzle. Remove the Nozzle from Gas Valve and gently clear any obstruction with a fine wire. Then reinstall all Nozzles, Burners, Screws and cooking components. Perform LPG leak test at all connections as described on page 11. If an obstruction is suspected in Gas Valves or Gas Valve Bracket, please call De'Longhi Customer Service for assistance.

**Problem:** Misalignment of Ignitor on Burner

**Correction:** Check for proper position of the Electrode Tip as shown on Page 8. The gap between the Spark Electrode Tip and Spark Receiver should be approximately 5mm. Adjust if necessary. With the gas supply closed and all Control Knobs set to OFF press the Electric Ignitor Cap and check for the presence of a spark at the Electrode.

**Problem:** Disconnected Ignition Wires

**Correction:** Inspect the Ignition Module found behind the Control Panel. Connect loose Ignitor wires to junction box and try to light the Outdoor Cooking Centre.

**Problem:** Weak ignition - AA battery

**Correction:** Unscrew the Ignitor Cap and replace the battery.



## Parts List (cont'd)

REF#	DESCRIPTION	PART#	QTY
70	Support for Heat Shield-L	142501/1004	1
71	Support for Heat Shield-R	142501/1005	1
72	Manifold Assembly	142702/1300	1
73	Manifold Assembly	142705/1600	1
74	Electronic Ignitor	142801/7000	1
75	Grease Tray handle	142601/1202	1
76	Grease Tray Support	142705/0109	1
77	Grease tray	142601/1203	2
78	Grease Tray Slider-L	142501/1006	1
79	Grease Tray Slider-R	142501/1009	1
80	Tank Drawer	142805/5402**	1
81	Slide Kit Support	142501/5600**	8
82	Tank Drawer Slider-L	142501/5403**	3
83	Tank Drawer Slider-R	142501/5404**	3
84	Handle Bolt for tank Drawer	142501/5405**	1
85	Tank Drawer Lock	142501/5801&5802**	1
86	Cart Crossmember	142705/3801	1
87	Cart Crossmember Support-L	142805/5005	1
88	Cart Crossmember Support-R	142805/5006	1
89	Door Magnet	142501/5302	1
90	Cart Side Panel-L	142805/5001	1
91	Gas Hose Sheath	146301/2025	2
92	Cart Side Panel-R	142805/5002	1
93	Cart Back Panel	142705/3002	1
94	Cart Heat Shield	142705/5004	1
95	Cart Bottom Panel	142601/3301	1
96	Cross Ignition Hoods	142702/1402	5
97	Back Burner Bracket	142701/2002	1
98	Front Pin	142705/3701	1
99	Door Spindle	142501/5105	2
100	Pin 6*12	*	6
101	Split Pin 2*15	*	6
102	Block	142501/1007	16
103	ULPG Regulator and Hose	142705/6000	1
	NG Regulator	Bromic OARA 98OL AGA# 5862	1
	NG Hose	Bromic Part# 10HST0300	1
104	Shield for smoker burner	142705/1601	1
105	Cross Ignition for smoker	142705/1404	1
106	Side Burner Shelf Bracket Kit	142709/4200	2

\* Can be purchased at local hardware store.

\*\* Part omitted for DELUX9FS21NG model. Not required for use with Natural Gas model.

### TOOLS REQUIRED (For assembly and adjustments)

- Adjustable Spanner.
- Phillips head screwdriver.
- Small terminal flathead screwdriver (to adjust side shelf grub screw).

Record your Outdoor Cooking Centre serial number below for future reference.

SERIAL NUMBER \_\_\_\_\_

## Assembly Instructions

### Battery Powered Ignition (Main)

1. Unscrew the Ignitor Cap located on the Control Panel.
2. Place the supplied AA battery into the Ignitor Slot. Be sure to place the positive pole (marked + on the battery) facing toward you.
3. Screw the Ignitor Cap back onto the Control Panel ensuring the Spring fits around the AA battery.



### Battery Powered Ignition (Side Burner)

1. Unscrew the Ignitor Cap located on the Side Burner Shelf.
2. Place the supplied AA battery into the Ignitor Slot. Be sure to place the positive pole (marked + on the battery) facing toward you.
3. Screw the Ignitor Cap back onto the Control Panel ensuring the Spring fits around the AA battery.



### Electrode Check-Requires an Assistant

Before placing the cooking components into your Outdoor Cooking Centre, ensure that the Spark Electrode Tip is properly positioned within each Gas Collector Box.

The easiest way to ensure this is to perform the following Electrode Check:

1. Be sure all Control Knobs are set to "OFF". Open the Hood.
2. Have an assistant stand to the right of the grill and look down at the Gas Collector Box of the Main Burners. NEVER put your face inside hood area.
3. Press Ignitor Cap and have assistant watch for a small blue spark within each Gas Collector Box. If a spark is present the Electrode Tips are properly positioned.
4. If no spark is seen, the Spark Gap shown in the illustration below right needs to be adjusted as follows:

Using an adjustable spanner, loosen the inside Nut just until the Gas Collector Box can be manoeuvred and turned upward. The gap between the Spark Electrode Tip and Spark Receiver should be approximately 5mm.

If the gap is wider than 5mm, use a pair of long nose pliers and gently squeeze the Gas Collector Box until the gap is correct. Return the Gas Collector Box to its original horizontal position, secure the inside Nut and try the Electrode Check again.

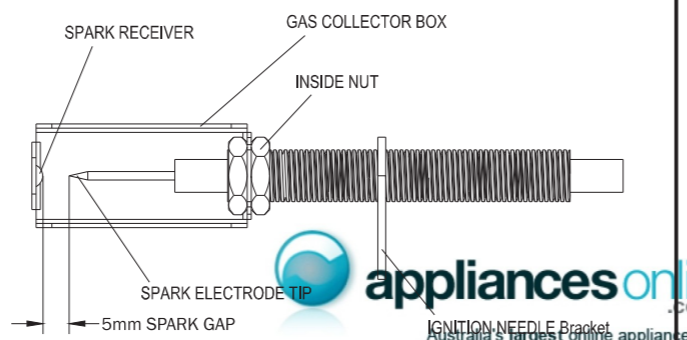
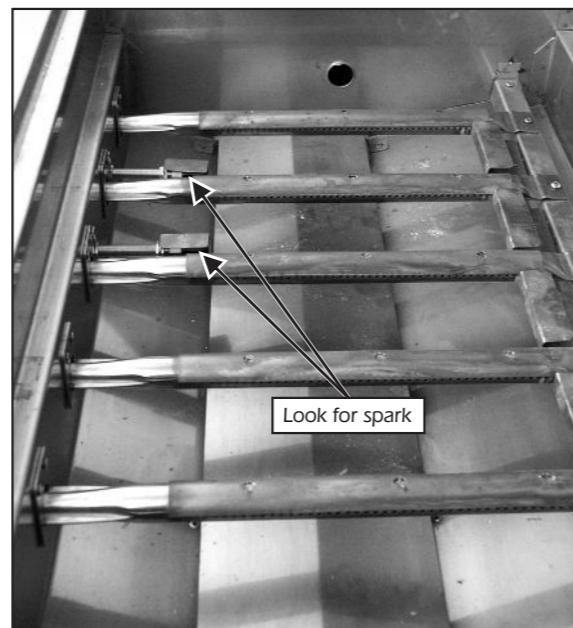

## Natural Gas Installation (For DELUX9FS21NG model only)

**WARNING:** Installing the Outdoor Cooking Centre for use with Natural Gas should only be done by authorised persons and in accordance with the manufacturer's installation instructions, local gas fitting regulations, municipal building codes, AS 5601-2004 - Gas Installations and any other statutory regulations.

### PARTS ALREADY FITTED BY MANUFACTURER

- Natural Gas Injectors fitted & bypass screw adjusted.
- No longer than 300mm Stainless Steel Hose, 10mm I.D., 1/2" BSP Male to 3/8" SAE Female.
- NG Regulator Bromic Oara 98OL (AGA#5862).

### ADDITIONAL PARTS SUPPLIED FOR INSTALLATION

- Chain restraint (No longer than 80% of the gas hose length)

### INSTALLATION INSTRUCTIONS

1. Screw one end of the supplied chain restraint to the lower rear section of the trolley below where the gas hose exits the BBQ trolley. The other end should be attached to a fixed structural point close to where the hose connects to the bayonet point on the main gas line. The chain must be installed to ensure stress is not placed on the gas supply line if the barbecue is accidentally moved.
2. At the free end of the regulator, attach a Flexible Hose which complies with AS/NZS 1869 (AGA Approved), 10mm ID, class B or D, no more than 1.5m long and in accordance with AS5601. Feed the hose out the rear of the BBQ trolley through the allocated slot in the rear panel.
 

**Caution:** The Stainless Steel hose should not be subjected to abrasion, kinking or permanent deformation once fitted to the Outdoor Cooking Centre.
3. Connect the hose assembly to the bayonet point on the main gas line.
4. Follow the instructions on Page 13 to perform a Gas Leak Test on all gas connections.

Note: If the hose or regulator becomes damaged, replace it with the same item by contacting customer service & spare parts.

### CHECKING THE GAS PRESSURE

1. Turn off the gas supply.
2. Connect the pressure gauge to the pressure test point. This can be done by either removing the test point screw on the NG regulator or by removing one of the burners and measuring the test point pressure at the injector. Follow instructions on Page 24 to remove the burner (if needed).
3. Once the gauge is in position, turn the gas supply on.
4. Ignite the burner furthest away from the gauge and turn the knob to the "HIGH" position. Check that the reading measures 1.00kPa for Natural Gas. If not, adjust the regulator to obtain the stated pressure.
5. Once the pressure is set, switch off the burner, turn off the gas supply, and disconnect the pressure gauge.
6. Ensure the Outdoor Cooking Centre is returned to its normal operating state. Replace the screw in the NG regulator, or replace the burner if it has been removed. Perform a gas leak check on all gas connections to make sure there are no gas leaks at the test point or at any point in the connection to the inlet manifold.

### Note to Installer

**Before Leaving** - Check all connections for gas leaks with soap and water. DO NOT use a naked flame for detecting leaks. Ignite all burners both individually and concurrently to ensure correct operation of gas valves, burners and ignition. Turn gas taps to low flame position and observe stability of the flame for each burner individually and concurrently.

If the flame appears abnormal or fails to remain alight, you will need to adjust the by-pass setting. Remove the four control knobs for the main burners. Place a small slotted jewellers/precision screwdriver through the shaft of the gas valve. Turn the by-pass screw anti-clockwise until the burner stays alight and the flame appears normal with very little or no yellow tipping.

When satisfied with the Outdoor Cooking Centre, please instruct the user on the correct method of operation. In case the appliance fails to operate correctly after all checks have been carried out, refer to the authorised service provider in your area.



## Using the Rotisserie & Infrared Back Burner cont'd

### Food Preparation

When preparing poultry, truss the birds tightly so that wings and drumsticks are close to the body of the bird. The cavity of the bird may be stuffed prior to this. Pull the neck skin down and, using a small skewer, fix it to the back of the bird. Push the rotisserie spit through lengthwise, catching the bird in the fork of the wishbone. Centre the bird and tighten with the holding forks. It may also be necessary to wrap the food with butcher string (never use plastic or nylon string) to secure any loose portions.

A rolled piece of meat requires the rotisserie skewer to be inserted through the centre of the length of meat, then secured and balanced.

For meats that contain bones, it is best to secure the rotisserie skewer diagonally through the meaty sections. If protruding bones or wings brown too quickly, cover with pieces of foil.

### Tips for Using The Back Burner

The location of the back burner makes it more susceptible to winds that will decrease the performance of your rotisserie cooking. For this reason you should not operate the back burner during windy weather conditions.

For best results, always rotisserie cook with the hood down and the Back Burner control knob set to HIGH.

DO NOT use the main grill burners when the Back Burner is in operation.

## Using the Smoker Drawer

### Preparing to Smoke Food

Smoking gives food a distinctive, delicious flavour. You will find a variety of wood chips or pellets available for use in smoking grilled foods. Pre-soaking of wood chips may be required so read and follow the manufacturers instructions for preparation of smoking chips prior to filling the smoker drawer.

### Using The Smoker Drawer

Start your Outdoor Cooking Centre and allow it to reach the desired cooking temperature for the food you are grilling. Wear an insulated cooking glove and pull the smoker drawer out of the Outdoor Cooking Centre and fill with your prepared smoking chips. Dried herbs and spices may also be added to produce different flavours. Return the smoker drawer to the Outdoor Cooking Centre, light the Smoker Burner following the instructions on Page 16, the heat will produce smoke and season the food.

### Tips for Smoking Food

You can reduce the strength of the smoke flavour by only smoking for half or three quarters of the cooking time. The heat required for smoking is normally low to medium.

Foods naturally high in oils lend themselves well to smoking, while drier foods benefit from a marinade. You can also rub the food with herbs, spices or flavoured oils. Many foods can be smoked to produce stunning results with very little effort.

#### Here are a few suggestions for marinating food:

- Tuna steaks, marinated in Asian flavours of sesame oil, soy sauce and sherry.
- Pork fillets, rubbed with ginger, orange rind and brushed with maple syrup.
- Mussels, brushed with lemon rind and chilli oil.
- Lamb cutlets, marinated in virgin olive oil, lemon, oregano and black pepper. The same marinade can be used for a whole leg or rack of lamb.

#### Here are a few suggestions for smoking food:

- Boneless chicken, chicken pieces, specially sliced chicken breasts smoked with Hickory.
- Fish fillets and assorted seafoods such as prawns, scallops and calamari smoked with Applewood.
- White & red meats such as beef, lamb, duck, and pork smoked with Hickory or Mesquite.

## Assembly Instructions

### Preparing the Cooking Surface

Important: Before cooking on your Outdoor Cooking Centre for the first time, wash the Solid Plate, Open Grills and Warming Rack with warm, soapy water. Rinse and dry thoroughly. After cooking is completed, turn knobs to HIGH setting for about three to five minutes to burn off excess grease or food residue.

REMOVE ALL TRANSIT PROTECTION FITTED TO THE OUTDOOR COOKING CENTRE

1. Open the hood and remove the Solid Plate & Open Grills. Remove the packing material and temporarily place the Grills & Plate off to the side.
2. Ensure the Smoker Burner shield is screwed securely in place.
3. Carefully unpack the carton containing the Ceramic Flame Tamers and place them in position on the Wire Racks. The Ceramic Flame Tamers can be used either side up.
4. Place the Solid Plate & Open Grills back onto the ledge above the Flame Tamers in the positions shown.

**WARNING:** Always use an Open Grill over the Smoker Burner on the right hand side of your Outdoor Cooking Centre. For your safety **DO NOT** place solid plates over the entire cooking surface as it will cause overheating.

5. Fit the Warming Rack on the Warming Rack Bracket.



## Assembly Instructions

### Installing Side Burner Shelf

REMOVE ALL TRANSIT PROTECTION

1. Place the side shelf assembly into the slot of the side shelf bracket.
2. Insert the two locking pins through the holes in the side shelf bracket and shelf support. Repeat procedure for front & rear brackets.
3. Insert the split pins and separate the pin legs to hold in place. Repeat procedure for all four pins fitted to the front & rear brackets. Check that the Side shelf is secure and that the pins are all held securely in position.
4. Open the left cabinet door. Feed the side burner gas hose through the hole allocated in the left side of the trolley.
5. Attach the side burner hose to the fitting on the side burner valve. Tighten with the supplied spanner. Be careful not to over-tighten and damage the connection.
6. Follow instructions on Page 13 to perform a gas leak test on your new side burner connection.

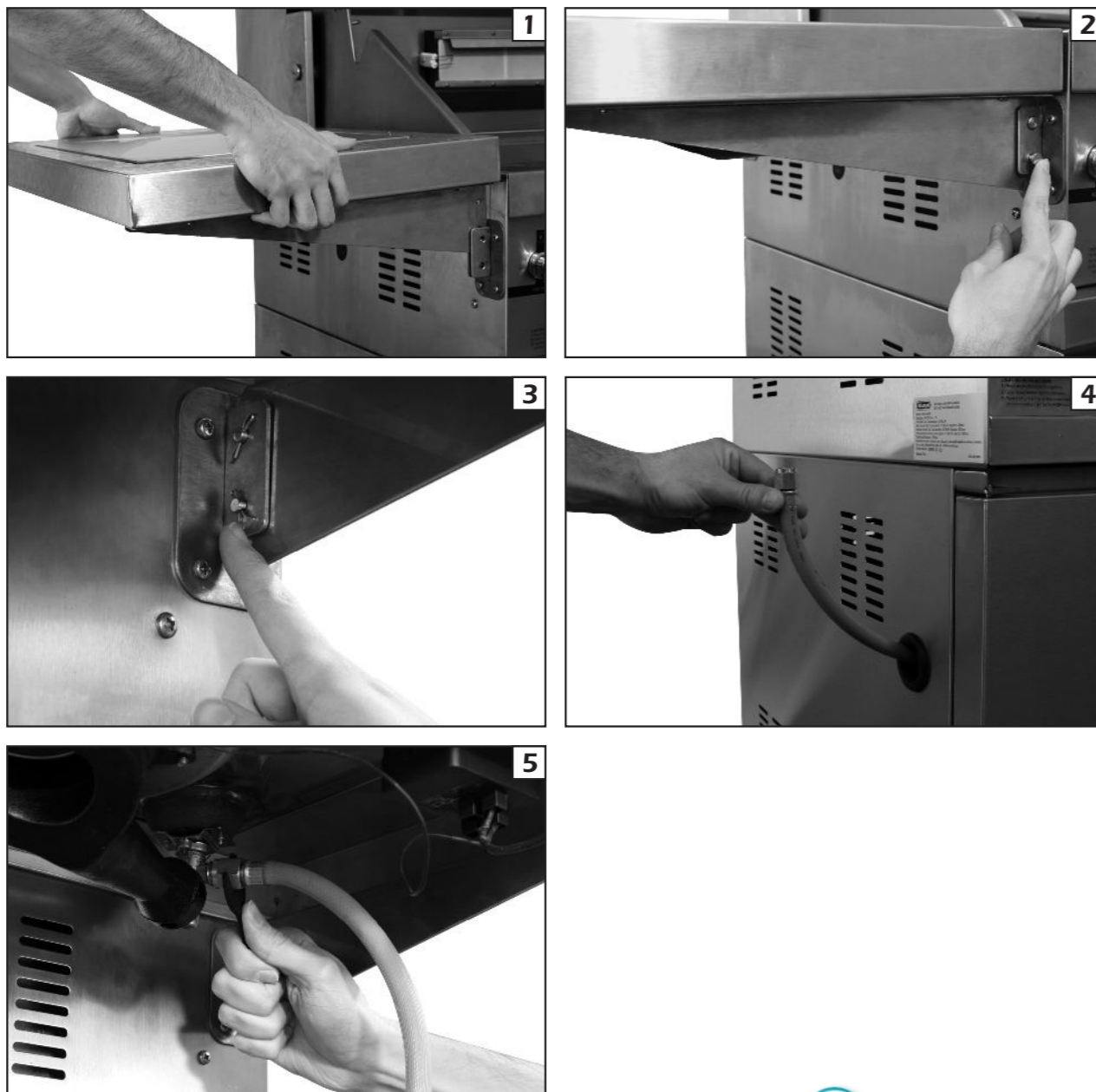

## Using the Rotisserie & Infrared Back Burner

BEFORE rotisserie cooking, you will need to remove the Solid Plate & Open Grills and possibly the Flame Tamers from your Outdoor Cooking Centre. When rotisserie cooking, place a Cooking Pan under the food to be cooked. This will capture the drippings and keep your Outdoor Cooking Centre clean of excess grease, which could cause a fire. Use caution when moving a Cooking Pan containing hot oils.

**NOTE:** The bushing collar must always be used with this Rotisserie.

### Using your Infrared Back Burner and Rotisserie

Your Outdoor Cooking Centre includes an Infrared Back Burner and a Rotisserie designed to slowly cook foods that are moist and flavourful, because the turning food self bastes using infrared heat. The location of the Back Burner allows the placement of a basting pan beneath the food to collect juices and drippings for basting and gravy. To flavour the contents of the basting pan you may add herbs, onions, or other spices of your choice. The Rotisserie Burner is Infrared, which provides intense radiant heat. This intense heat is magnificent for searing in the natural juices and nutrients found in quality cuts of meat.

Rotisserie cooking is a slow cooking process and the maximum temperature you can expect to reach with the hood closed is about 163°C to 177°C, depending on weather conditions.

To light the back burner, turn the control knob to the "HIGH" position, press and hold the Electric Igniter for 3-4 seconds to light the burner. If the Burner does not light, turn the control knob to "OFF", wait 5 minutes for the gas to clear, then retry.

### Using your Lamp

Your Outdoor Cooking Centre includes a Lamp which is installed on the rotisserie motor. Plug the 3-prong grounded plug into a mating 3-prong grounding type receptacle, then press the button for Lamp, the Lamp will light. You can use the Lamp to observe your food when you are cooking at night.

If the Lamp is lit, the vents may be hot. For your safety, do not touch the vents or Rotisserie motor surfaces.

### IMPORTANT SAFEGUARDS

When using electrical appliances, basic safety precautions should always be used, including the following:

1. Always attach the assembled Rotisserie to your Outdoor Cooking Centre first, then plug the Cord into an outlet. To disconnect, turn the Rotisserie "OFF" then remove the Plug from outlet.
2. Most Outdoor Cooking Centre surfaces and Rotisserie parts are hot during and after cooking, so use reasonable care and wear protective mitts. Only manoeuvre the Rotisserie by its Handle.
3. To protect against electrical shock, do not immerse Electrical Cord, Plug or Motor in water or expose to rain. Protect electrical cord from burners, hot grill surfaces and grease.
4. Do not operate the Rotisserie if the cord or plug becomes damaged, or if the Rotisserie malfunctions or has been damaged in any manner.
5. Do not let children operate your Outdoor Cooking Centre or Rotisserie, and do not let children play nearby.
6. Unplug the Rotisserie from electrical outlet when not in use and before cleaning. Allow to cool before adding or removing parts. When the Rotisserie is not in use, store it indoors in a dry place.
7. The use of accessory attachments is not recommended by the manufacturer and may cause injuries. Do not use this Rotisserie for other than intended use.
8. When rotisserie cooking place a Cooking Pan under the food to be cooked. This will capture the drippings and keep your Outdoor Cooking Centre clean of excess grease which could cause a fire. Use caution when moving a Cooking Pan containing hot oils.
9. Never line the bottom of your burner housing with aluminum foil, sand or any grease absorbent substance.
10. Should a grease fire occur, turn the burners and gas off and leave the hood CLOSED until the fire is out.
11. The rotisserie motor is set for 240V 50Hz AC current. A short power cord is provided to reduce the risk resulting from becoming entangled in or tripping over a longer cord. Extension cords may be used if care is exercised in their use. If an extension cord is used the marked electrical Rating should be at least as great as the electrical rating of the appliance and suitable for outdoor use with a 3-wire grounding type cord. The cord must be arranged so that it will be protected from burners, hot surfaces, grease and where it can be pulled on by children or tripped over unintentionally.
12. The Outdoor Cooking Centre and rotisserie is for use outdoors only.

## Rotisserie Assembly

1. Remove all components from the carton.
2. Slide a Holding Fork onto each end of the Rotisserie Spit. Adjust spacing between Holding Forks to accommodate your food, then tighten the Thumbscrews to keep the Holding Forks in position. Slide the Bushing Collar onto the threaded end of the Spit. Do not tighten the Bushing Collar Thumbscrew until the Rotisserie is placed into your Outdoor Cooking Centre. Slide the balance block onto the threaded end of the Spit. Last, screw the Handle and balance block onto the threaded end of Rotisserie Spit as shown.

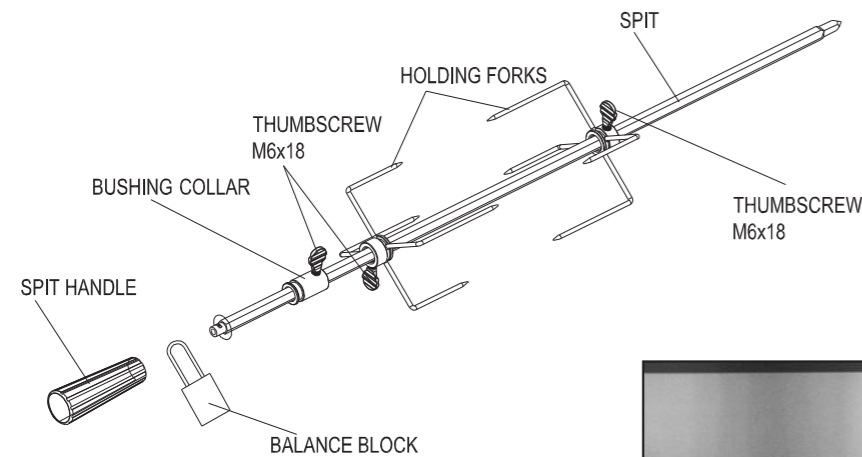

3. Install the AC (alternating current) Rotisserie Motor onto the Motor Bracket as shown right. Be sure the Motor attaches to the Bracket with the electrical cord down. This installation ensures that once the Spit is inserted into the Motor it will also rest securely into the slot of your burner housing.

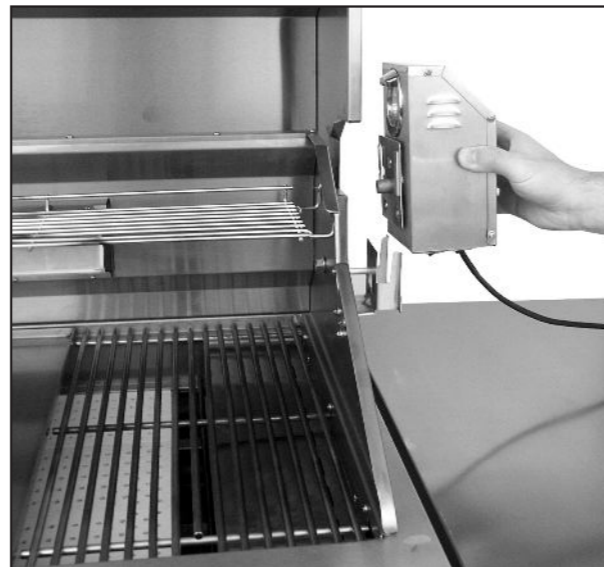

4. Insert the assembled Rotisserie into the Motor as shown below. The Motor should be on the right side of your Outdoor Cooking Centre and the Handle on the left side. Place the Bushing collar into the slot opening on the left side of your burner housing, then tighten the Bushing Collar Thumbscrew. The Bushing Collar will stabilize the Rotisserie during the cooking process and the Bushing collar allows the Rotisserie Spit to turn smoothly. Plug the Rotisserie into an outlet and turn on to test.

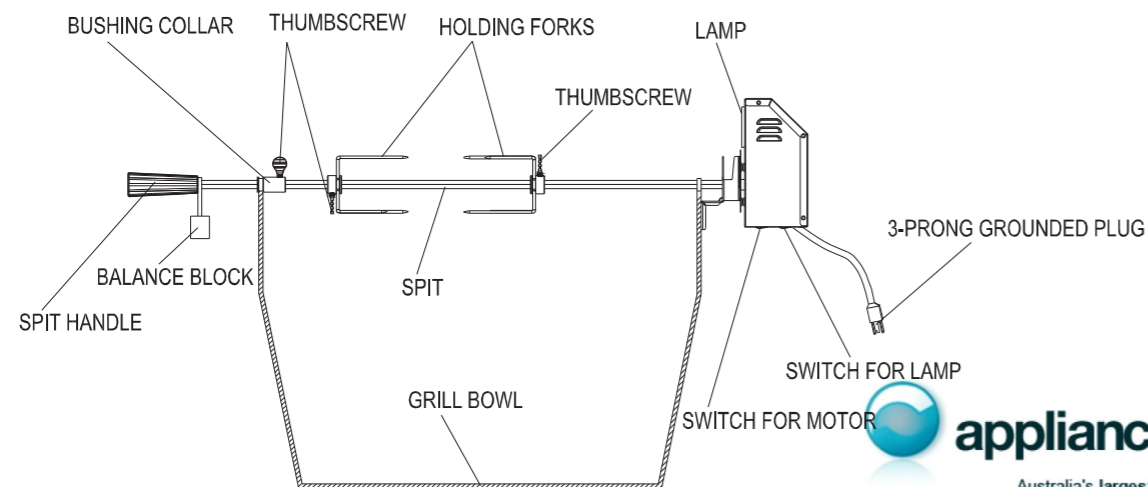

## Assembly Instructions

### Installing Right Side Shelf

1. Place the side shelf assembly into the slot of the side shelf bracket.
2. Insert the locking pin through the hole in the side shelf bracket and the slot in the side shelf, then add the split pin to lock it in place. Repeat procedure for front & rear brackets.

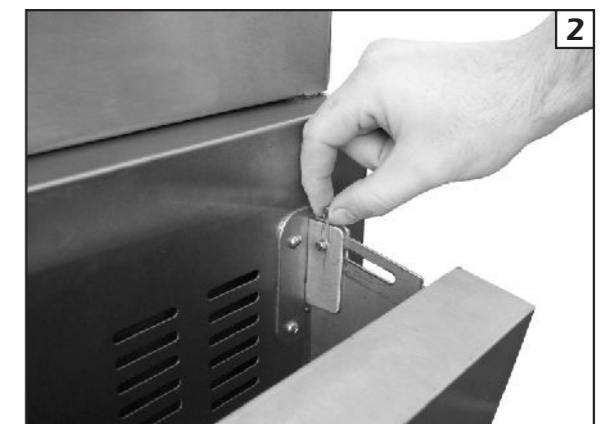

## Assembly Instructions

### Choosing A Liquid Propane Gas (LPG) Cylinder (For DELUX9FS21 model only)

The LPG cylinder to be used must be constructed and marked in accordance with the Specifications for LP-gas Cylinders of the Australian Standard AS2030. Only use up to a 9kg max. cylinder equipped with a Type 21 POL fitting. The LPG cylinder must include a collar to protect the cylinder valve.

Consult your local gas dealer to obtain the correct LPG cylinder.

If the appliance is not in use, the LPG cylinder must be disconnected.

The LPG cylinder must not be stored indoors. It must be stored outdoors in a well ventilated area, out of direct sunlight, sheltered from the rain, away from dangerous goods and out of the reach of children. It may be stored in outdoor enclosures as defined on page 4.

Your LPG cylinder must never be stored where temperatures can reach over 50°C.

Disconnect the LPG cylinder from the regulator valve when the Outdoor Cooking Centre is not in use. DO NOT obstruct the flow of combustion air and ventilation air to the Outdoor Cooking Centre.

DO NOT store spare LPG cylinders within, under or near this Outdoor Cooking Centre.

A fire causing deaths or serious injury may occur if the above is not followed exactly.

ALWAYS close LPG cylinder valve after use of your Outdoor Cooking Centre.

### Connecting A Liquid Propane Gas (LPG) Cylinder To Your Grill (For DELUX9FS21 model only)

1. Open the left door. Pull out the LPG cylinder Drawer. Place the 9kg cylinder with foot ring into the hole in the Drawer. Make sure the Cylinder Valve is in the OFF position.

Make sure the Gas Cylinder Valve faces to the left and turn the Handle in the cylinder drawer clockwise to secure the gas cylinder in place.

2. Check the Cylinder Valve to ensure it has proper mating threads to fit the Regulator and Hose Assembly provided.

#### USE ONLY THE REGULATOR PROVIDED.

If a replacement is necessary, please call our customer service centre. The use of unauthorised parts can create an unsafe condition and environment.

3. Make sure all Burner Valves are in the OFF position.
4. Inspect the Valve connection port and Regulator Assembly. Look for damage or debris. Remove any debris. Inspect Hose for damage. Never use damaged or plugged equipment.
5. When connecting the Regulator and Hose Assembly to the Cylinder Valve, hand tighten anti-clockwise to a full stop. Do Not use a wrench to tighten because it could damage the fitting and result in a hazardous condition.
6. Open the Cylinder Valve fully (counterclockwise). Use a soapy water solution to check all connections for leaks before attempting to light your Outdoor Cooking Centre. See "Checking for LPG Leaks" on page 13. If a leak is found, turn the Cylinder Valve off and do not use your Outdoor Cooking Centre until the leak is repaired.

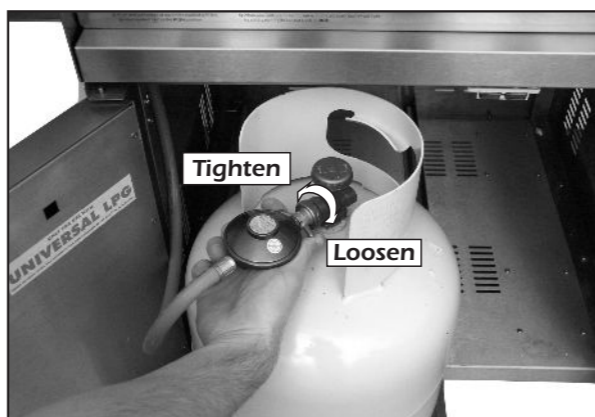
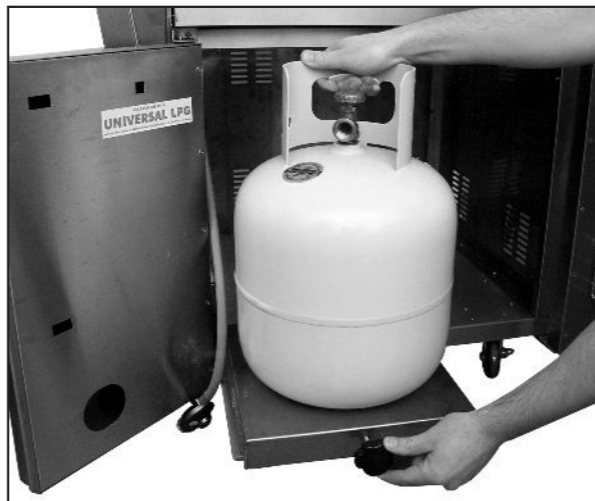

## Side Burner Lighting Instructions

### Side Burner Lighting Procedures

**WARNING: DO NOT** light the side burner with a vessel/pot in place on the burner. Light the burner first, and then place the vessel over the burner.

1. Familiarise yourself with the safety guidelines at the front of this manual.
2. Make sure all gas connections are securely tightened and you have performed the gas leak test described on page 13.
3. Open the Side Burner Lid to the upright position and allow it to slide down carefully into the tray until it comes to rest. Always keep the Side Burner Lid open during lighting and operation. Failure to do so could result in a fire or explosion that could cause serious bodily injury, death, or property damage.
4. With the gas supply valve open turn the Side Burner Control Knob to HIGH and immediately press the igniter for 3-4 seconds to light the burner. If you cannot see a spark and hear the igniter ticking, follow the instructions on Page 8 to check and replace the igniter battery if necessary.
5. If the Burner still does not light, turn the Control Knob to OFF, wait 5 minutes for gas to clear, then retry.
6. After use, turn the Control Knob to the OFF position. Fully close the gas supply at the valve once you have finished cooking.



If your side burner fails to remain alight, avoid 'front on' winds by repositioning the direction of your Outdoor Cooking Centre.

In case the appliance fails to operate correctly, contact the De'Longhi authorised service representative in your area.

### Manually Lighting the Side Burner

1. To light your side burner manually with a match, insert a match into the Match Holder provided and light the match.
2. With the gas supply valve open, turn the Side Burner Control Knob to HIGH.
3. Place the lit match near the burner head to light the burner.

**WARNING:** Never lean over the cooking area while lighting your side burner. Keep your face and body a safe distance (at least 460mm) from the burner when lighting with a match. DO NOT place your hand near the flame, use the Match Holder for safe lighting.

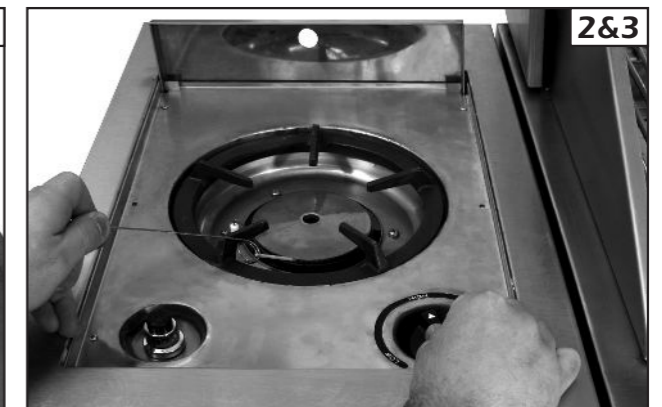
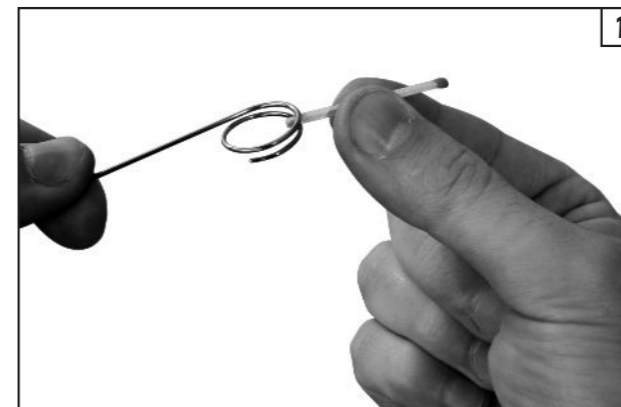

## Basic Grill Lighting Instructions cont'd

### Recognising Abnormal Operation

Any of the following are considered to be abnormal operation and may require servicing:

- Yellow tipping of the burner flame.
- Burners failing to remain alight.
- Sooting up of the grill plates.
- Burners extinguished by trolley door.
- Burners not igniting properly.
- Gas valves, which are difficult to turn.

In case the appliance fails to operate correctly, contact the De'Longhi authorised service representative in your area.

### WARNING

Should a "FLASH-BACK" fire occur in/or around the Burner Tubes, follow the instructions below. Failure to comply with these instructions could result in a fire or explosion that could cause serious bodily injury, death, or property damage.

- Shut off gas supply to the Outdoor Cooking Centre.
- Turn the Control Knobs to OFF position.
- Put out any flame with a fire extinguisher.
- Open hood.
- Once the Outdoor Cooking Centre has cooled down, clean the Burner Tubes and Burners according to the cleaning instructions found on page 20 in this manual.

## Smoker Burner Lighting Instructions

1. Follow steps 1 through 4 of the Basic Lighting Procedures.
2. Push and turn the Control Knob for Smoker Burner to ON.



3. Immediately press the Electric Ignitor for 3-4 seconds to light the Burner.



4. If the Burner does not light, turn the Control Knob to OFF, wait 5 minutes for gas to clear, then retry.

## Assembly Instructions

### Disconnecting A Liquid Propane Gas (LPG) Cylinder From Your Outdoor Cooking Centre.

1. Turn the Burner Valves and LPG Cylinder Valve to the full OFF position. (Turn clockwise to close.)
2. Detach the Regulator and Hose Assembly from the LPG Cylinder Valve by turning the fitting counterclockwise.

**WARNING:** For storage and cylinder exchange, disconnect hose at the LPG cylinder. Do not disconnect hose from the appliance.

## Checking for Gas Leaks

Your Outdoor Cooking Centre has been checked at all factory connections for leaks. Recheck all connections, as movement in shipping can loosen connections. Check for leaks even if your unit was assembled for you at the store.

Never test for leaks with a flame. Prior to first use, and at the beginning of each season, or every time your LPG cylinder is changed, you must check for gas leaks, follow these four steps:

1. Make a soap solution by mixing one part liquid detergent and one part water.
2. Turn the Control Knobs to the full OFF position, then turn the gas ON at source.
3. Apply the soap solution to all gas connections. If bubbles appear in the soap solution the connections are not properly sealed, check each fitting and tighten or repair as necessary.
4. If you have a gas leak that you cannot repair, turn off the gas at the source, disconnect fuel line from your Outdoor Cooking Centre and call the manufacturer or your gas supplier for repair assistance.

### WARNING

A strong gas smell, or the hissing sound of gas indicates a serious problem with your Outdoor Cooking Centre or gas connection. Failure to immediately follow the steps listed below could result in a fire or explosion that could cause serious bodily injury, death, or property damage.

1. Shut off gas supply to your Outdoor Cooking Centre.
2. Turn the Control Knobs to OFF position.
3. Put out any flame with a Class B fire extinguisher.
4. Open hood.
5. Do not try to fix the problem yourself.
6. If odour continues or you have a fire you cannot extinguish, call your fire department.

Do not operate a telephone near the LPG cylinder because your telephone is an electrical device and could create a spark resulting in fire and/or explosion.

**NOTE:** The normal flow of gas through the Regulator and Hose Assembly can create a humming sound. A low volume of sound is perfectly normal and will not interfere with operation of the Outdoor Cooking Centre. If humming sound is loud and excessive you may need to purge the gas line. This purging procedure should be done every time a new LPG cylinder is connected to your Outdoor Cooking Centre. For help call the De'Longhi Customer Service.

To talk to a De'Longhi representative for further information, please call the number in your region.

Australia: 1800 126 659

New Zealand: 0508 200 300

## Basic Grill Lighting Instructions

### Basic Lighting Procedures

1. Familiarise yourself with the safety guidelines at the front of this manual.
2. Make sure all gas connections are securely tightened and you have performed the gas leak test described on page 11.
3. Open the Hood when lighting. Failure to do so during the lighting procedure could result in a fire or explosion that could cause serious bodily injury, death, or property damage.
4. Set Control Knobs to OFF and open the gas supply valve slowly until  $\frac{1}{4}$  to  $\frac{1}{2}$  open.



5. Push and turn either of the Control Knobs marked with the ignition symbol "⚡" for Main Burner to HIGH.



6. Immediately press the Igniter button for 3-4 seconds to light the Burner.



7. If the Burner does not light, turn the Control Knob to OFF, wait 5 minutes for gas to clear, then retry.
8. Once the grill Burner is ignited, the adjacent Burner can be lit by simply turning its Control Knob to HIGH.
9. Adjust Control Knobs and watch Temperature Gauge to achieve your desired cooking temperature.
10. After use, turn all Control Knobs to the OFF position. Fully close the gas supply at the valve.

## Basic Grill Lighting Instructions cont'd

### Manually Lighting Your Outdoor Cooking Centre With a Match

To light your Outdoor Cooking Centre with a match, insert a match into the Match Holder and follow steps 1 through 4 of the Basic Lighting Procedures. Then, light the match and place Match Holder through the Lighting Hole on the right side of the Outer Burner Housing. See right. Turn the adjacent Main Burner Control Knob to the HIGH setting to release gas. The Burner should light immediately.

**WARNING:** Never lean over the cooking area while lighting your Outdoor Cooking Centre. Keep your face and body a safe distance (at least 460mm) from the Lighting Hole or Burners when lighting your Outdoor Cooking Centre by match.

### If the Outdoor Cooking Centre fails to light properly:

1. Turn gas off at source and turn the Control Knob to OFF. Wait at least five minutes for gas to clear, then retry.
2. Check gas supply and connections.
3. Repeat lighting procedure. If your Outdoor Cooking Centre still fails to operate properly, turn the gas off at source, turn the Control Knobs to OFF, then refer to the Troubleshooting page.
4. If the Outdoor Cooking Centre still does not light you may need to purge air from the gas line. This procedure should be done every time a new LPG cylinder is connected to your Outdoor Cooking Centre.

### To purge air from your gas line (When using LPG cylinder):

- Turn the Control Knobs to the OFF position.
  - Turn off the gas at the Cylinder Valve.
  - Disconnect Regulator from LPG cylinder.
  - Let unit stand for 5 minutes.
  - Reconnect Regulator to the LPG cylinder.
  - Turn the Cylinder Valve on slowly until  $\frac{1}{4}$  to  $\frac{1}{2}$  open.
  - Open the Hood.
  - Push and turn the Control Knob for the Main Burner furthest away from the Fuel Source.
5. If all checks have been made and you still have questions about operating your Outdoor Cooking Centre, call De'Longhi Customer Service on the number in your area provided on Page 27.

