

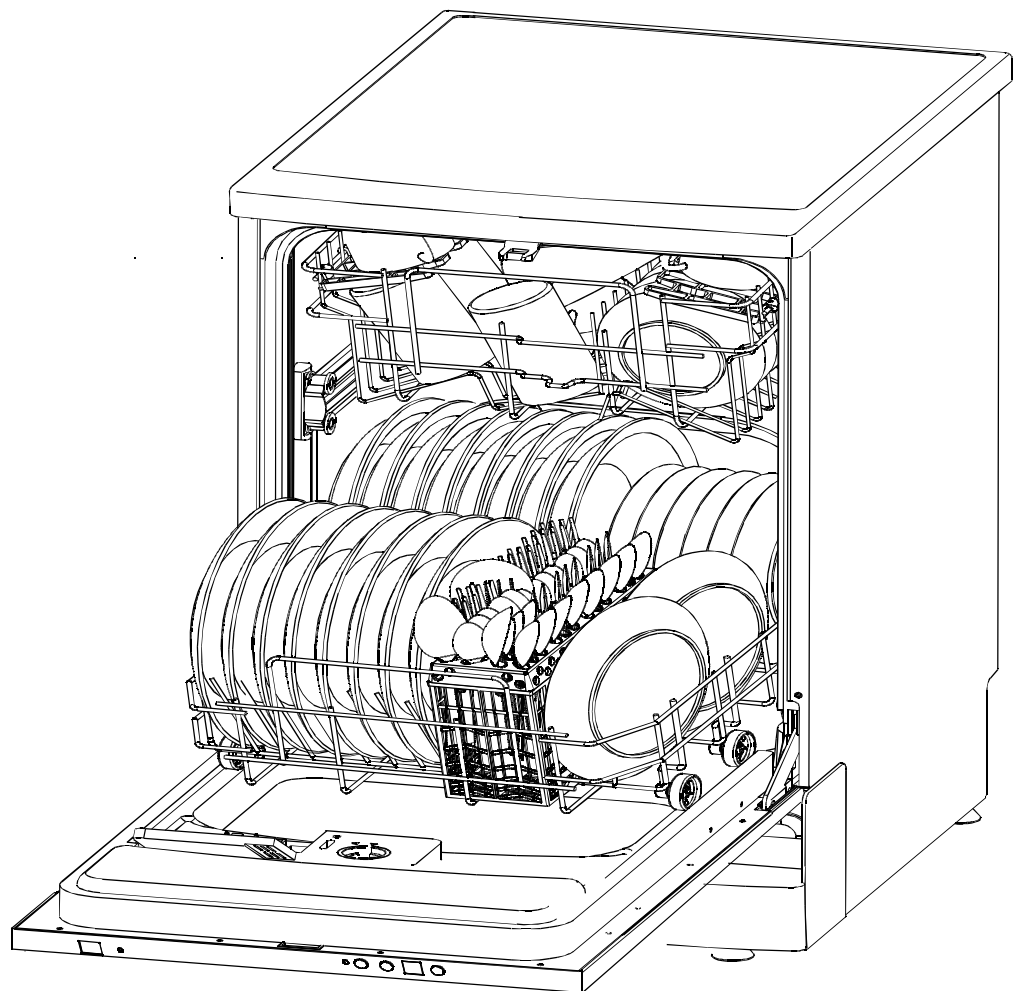

Instruction Manual

DW87S

Dishwashers





Read this Manual

This manual contains sections of Safety Instructions, Operating Instructions, Installation Instructions and Troubleshooting Tips etc. Carefully reading it before using the dishwasher will help you to use and maintain the dishwasher properly.



Before Calling for Service

To review the section on Troubleshooting Tips will help you to solve some common problems by yourself and not need to ask for the help of professional technicians.



NOTE:

The manufacturer, following a policy of constant development and up-dating of the product, may make modifications without giving prior notice.

Safety Information 1

Operating Instructions

Control Panel	2
Dishwasher Features	2
Wash Cycle Table	3
Turning On the Appliance	3
Detergent	4
Rinse Aid	5
Adjust the upper rack	6
Loading the Dishwasher Rack(14 sets) .	7,8
Not suitable for the dishwasher	8
Filtering System	9
Caring for the Dishwasher	9,10

Installation instruction

About Electricity connection	10
Water Connection	11

Troubleshooting Tips

Before calling for service.....	12,13
Fault codes.....	13

Technical information 14

IMPORTANT SAFETY INFORMATION

READ ALL INSTRUCTIONS BEFORE USING

⚠ WARNING!

When using your dishwasher, follow the below basic precautions including the following:

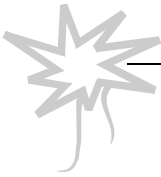

⚠ WARNING! HYDROGEN GAS IS EXPLOSIVE

Under certain conditions, Hydrogen gas may be produced in a hot-water system that has not been used for two weeks or more. HYDROGEN GAS IS EXPLOSIVE.

If the hot-water system has not been used for such a period, before using the dishwasher turn on all hot-water faucets and let the water flow from each for several minutes. This will release any accumulated hydrogen gas. As the gas is flammable, do not smoke or use an open flame during this time.



GROUNDING INSTRUCTIONS

- This appliance must be grounded. In the event of a malfunction or breakdown, grounding will reduce the risk of electric shock by providing a path of least resistance of electric current. This appliance is equipped with a cord having an equipment-grounding conductor and a grounding plug. The plug must be plugged into an appropriate outlet that is installed and grounded in accordance with all local codes and ordinances.

⚠ WARNING!

- Improper connection of the equipment-grounding conductor can result in a risk of electric shock. Check with a qualified electrician or service representative if you are in doubt whether the appliance is properly grounded. Do not modify the plug provided with the appliance; If it is not fit for the outlet. Have a proper outlet installed by a qualified electrician.



WARNING! PROPER USE

- Do not abuse, sit on, or stand on the door or dish rack of the dishwasher.
- Do not operate your dishwasher unless all enclosure panels are properly in place. Open the door very carefully if the dishwasher is operating, there is a risk of water squirting out.
- Do not place any heavy objects or stand on the door when it is open. The appliance could tip forward.
- When loading items to be washed:
 - 1) Locate sharp items so that they are not likely to damage the door seal;
 - 2) Load sharp knives with the handles up to reduce the risk of cut-type injuries.
 - 3) Warning: Knives and other utensils with sharp points must be loaded in the basket with their points down or placed in a horizontal position.
- Check that the detergent receptacle is empty after completion of the wash cycle.
- Do not wash plastic items unless they are marked dishwasher safe or the equivalent. For plastic items not so marked, check the manufacturer's recommendations.
- Use only detergent and rinse additives designed for an automatic dishwasher. Never use soap, laundry detergent, or hand washing detergent in your dishwasher. Keep these products out of the reach of children.
- Keep children away from detergent and rinse aid, keep children away from the open door of the dishwasher, there could still be some detergent left inside.
- Young children should be supervised to ensure that they do not play with the appliance.
- The appliance is not intended for use by young children or infirm persons without supervision.
- Dishwasher detergents are strongly alkaline, they can be extremely dangerous if swallowed. Avoid contact with skin and eyes and keep children away from the dishwasher when the door is open.
- The door should not be left in the open position since this could present a tripping hazards.
- Remove the door to the washing compartment when removing an old dishwasher from service or discarding it.
- Please dispose of packing materials properly.
- Use the dishwasher only for its intended function.
- During installation, the power cord must not be excessively or dangerously bent or flattened. If the power cord is damaged, it must be replaced by the manufacturer or its service representative or a similarly qualified person to avoid a hazard.
- Do not tamper with controls.
- The appliance is to be connected to the water mains using new hose sets and that old hose-sets should not be reused.
- The maximum number of place settings to be washed is 14.
- The maximum permissible inlet water pressure is 1 Mpa.
- The minimum permissible inlet water pressure is 0.04Mpa.

READ AND FOLLOW THIS SAFETY INFORMATION CAREFULLY

SAVE THESE INSTRUCTIONS

IMPORTANT!

To get the best performance from your dishwasher, read all operating instructions before using it for the first time.

Control Panel

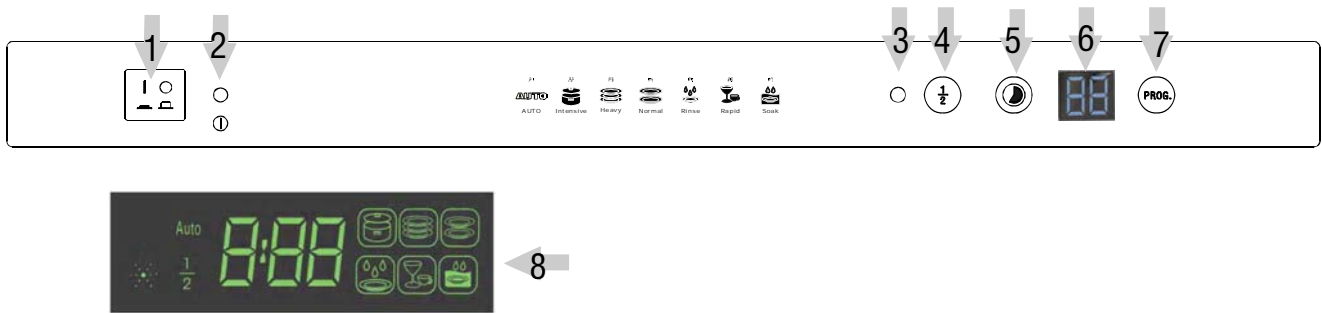





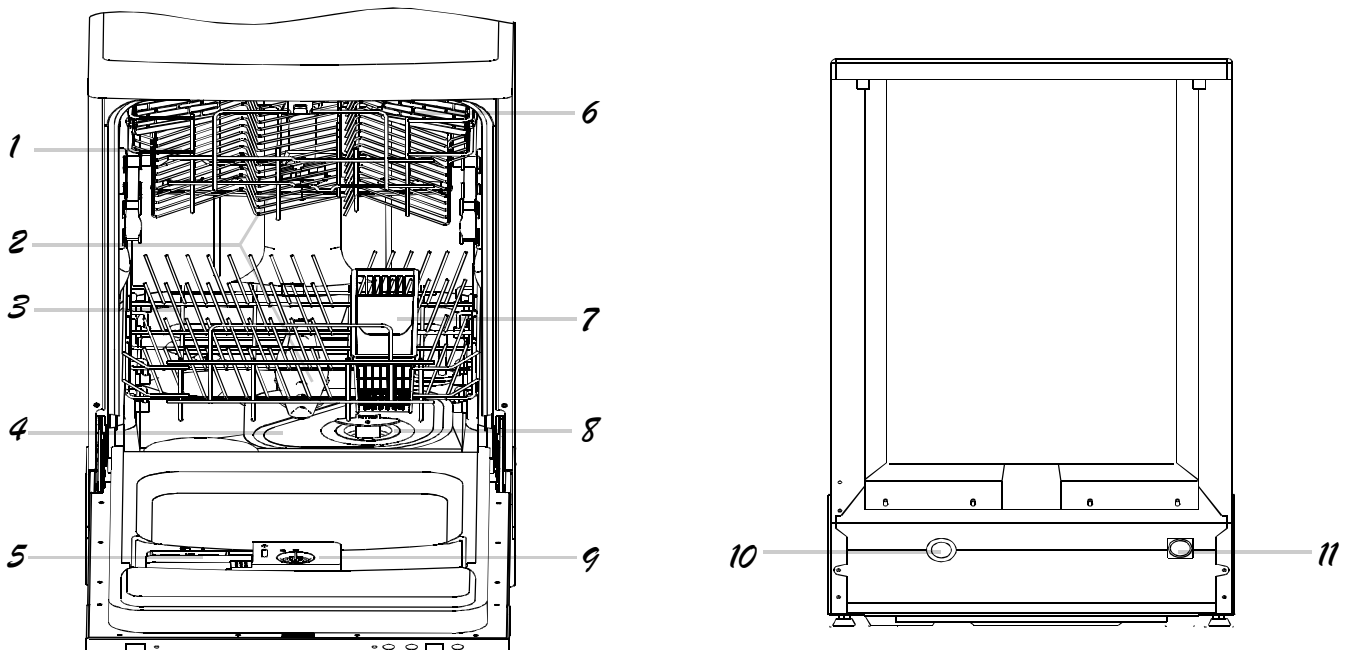







- 1 Power Switch: Turn on/off the power supply.
- 2 Power/ON Light: To come on when the ON/OFF Button is pressed down.
- 3 Half Wash Light : To come on when Half Wash has been selected.
- 4 Half Wash Key :Button to select Half Wash. (It means that the lower spray arm does not run, so you should load the upper basket only).
- 5 Delayed Start Button: Press this button to set the delayed hours for washing. You can delay the start of washing up to 24 hours. One press on this button delays the start of washing by half an hour.
- 6 Display Window: Delay time and fault codes and P1 to P7 will be displayed here, P1 to P7 correspond to the 7 programs .
- 7 Program Key-Press : Press it to choose the desired program.
- 8 Display Window: Program remaining time, delay time, running indicator, fault codes and etc.

Dishwasher Features



- 1 Upper Basket
- 2 Spray Arms
- 3 Lower Basket
- 4 Main Filter
- 5 Detergent Dispenser
- 6 Cup Shelf
- 7 Silverware Basket
- 8 Coarse Filter
- 9 Rinse Aid Dispenser
- 10 Drain pipe connector
- 11 Inlet pipe connector

WASH CYCLE TABLE

Program	Cycle	Cycle Selection Information	Description of Cycle	Detergent pre/main	Rinse Aid
P1	Auto		Automatically selects the washing time, temperature, and the number of rinses	Pre-wash Autowash Rinse Rinse Drying.	5/30 g. 
P2	Intensive		For the heaviest soiled loads, such as pots, pans, casserole dishes and dishes that have been sitting with dried food on them for a while.	Pre-wash (45°C) wash (50°C/70°C) Rinse Rinse Rinse (70°C) Drying.	5/30 g. 
P3	Heavy		For heavy soiled loads such as pots, plates and glasses	Pre-wash Pre-wash Wash (50°C) Rinse Rinse (70°C) Drying.	5/30 g. 
P4	Normal	 (AS/NZS 2007.1)	For normal soiled loads, such as plates, glasses, bowls and lightly soiled pans. Standard daily cycle.	Pre-wash Pre-Wash Wash (50°C) Rinse 60°C Drying.	2.5/30 g. 
P5	Rinse		For dishes that need to be rinsed and dried only.	Rinse Rinse (70°C) Drying.	
P6	Rapid		A shorter wash for lightly soiled loads that do not need drying.	Wash (40°C) Rinse (50°C) Rinse	20 g.
P7	Soak		To rinse dishes that you plan to wash later that day.	Rinse	

AUTOWASH FUNCTION

During the Auto program, the degree of soiling in the dishes is determined by the amount of clouding of the water. According to the degree of soiling, the program automatically adjusts the washing time, temperature, the number of rinses. As a result, the energy and water consumption is kept at an appropriate level, and the remaining time on display could be changed according to the status of the dishwasher.

WARNING!

If overflow occurs, turn off the main water supply before calling a service. If there is water in the base pan because of an overflow or small leak, the water should be removed before restarting the dishwasher.

Turning on the Appliance

Starting a wash cycle. . .

- 1 Draw out the lower basket load the dishes and push back. Repeat for the upper basket. It is recommended that you load the lower basket first.
- 2 Add detergent for your selected wash cycle – refer page 3
- 3 With a little force to ensure the door is properly closed.
NOTE: A click could be heard when the door is closed perfectly.
- 4 Insert the plug into the socket.
The power supply is 240VAC 50HZ, the specification of the socket is 12A 250VAC.
- 5 Press the ON/OFF button
- 6 According to the soil level to choose the desired program by pressing the program selection button.
- 7 Close the door to start the washing.
- 8 When the washing is over, you can shut off the switch by pressing on/off button..

NOTE: If you open and close the door during the washing process, the machine will delay the start for several seconds.

DETERGENT DISPENSER

The dispenser must be refilled before the start of each wash cycle following the instructions provided in the " Wash Cycle Table". Generally, only one tablespoon of detergent is needed for a normal wash load. Also, more heavily soiled items need more detergent. Always add the detergent just before starting dishwasher, otherwise it could get damp and will not dissolve properly.

Amount of Detergent to Use

If the water isn't too hard, you may also prevent the formation of deposits by adding detergent. For the dosage of detergent, please refer to the "Detergent" ("section entitle wash cycle table")

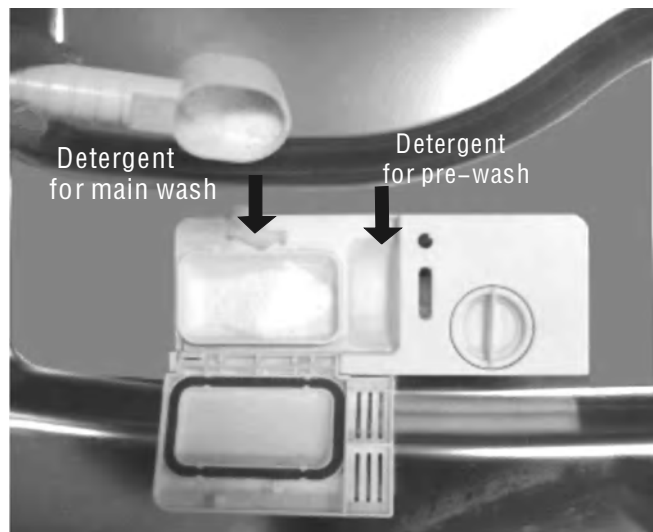
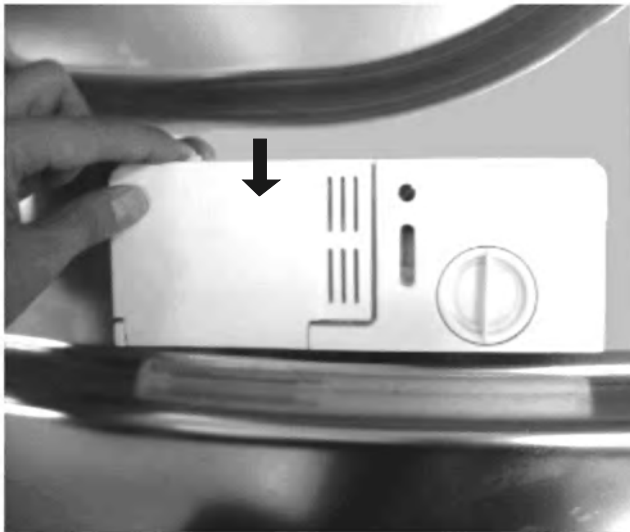

Removing Hard Water Spots

To remove hard water spots, try the following:

- Run dishes through a normal wash program.
- Remove all metal dishware, such as cutlery, pans, etc., from the dishwasher.
- Do not add detergent.

If this doesn't work, try the same process with 1 / 4 cup of citric acid crystals instead of vinegar.

▲ WARNING!

Dishwasher detergent is corrosive! Take care to keep it out of reach of children.

Change the Programme

Premise: A cycle that is underway can only be modified if it has only been running for a short time. Otherwise, the detergent may have already been released, and the appliance may have already drained the wash water. In this case, the detergent dispenser must be refilled (see the paragraph entitled " Loading the Detergent ").

When the dishwasher is running, you want to change the using programme, you should do according the following step.

- 1 Open the door ,Please press the programme button and last more than three seconds.
- 2 Press the programme button to select the desired programme.
- 3 Close the door to start washing.

NOTE: If you open the door when washing, the machine will pause. When you close the door and the machine will keep on working after 10 seconds.

At the end of the wash cycle

At the end of a wash cycle, the time display will flash for 8 seconds while the buzzer sound. However, when the delay start function is activated, the time display will flash for 8 seconds, but the buzzer will not sound.

- Pour two cups of vinegar into a bowl and set the bowl face up on the lower rack of the dishwasher.
- Run the dishes through a normal wash program.

Proper Use of Detergent

Use only detergent specifically made for use in dishwashers. Keep your detergent fresh and dry. Don't put powder detergent into the dispenser until You're ready to wash dishes. Follow the detergent manufacture's recommendation on detergent.

RINSE-AID DISPENSER

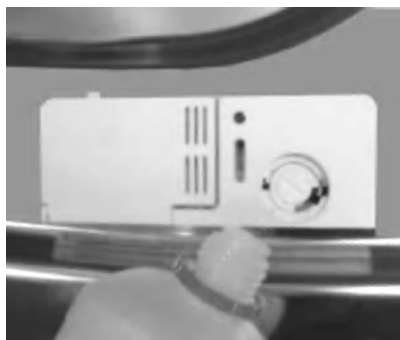
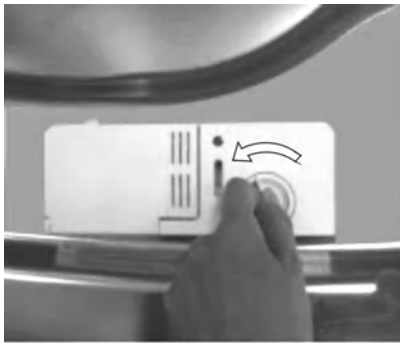

Steps to fill rinse-aid

- To open the dispenser, turn the cap to the "open" (left) arrow and lift it out.
- Pour in rinse-aid into the container is fill (approx . 140 ml) , Being careful not to overfill.
- Replace the cap by inserting it aligned with "open" arrow and turning it to the closed (right) arrow.

Your dishwashers are designed to use liquid rinse aids. The rinse aid dispenser is located inside the door next to the detergent dispenser.

The rinse aid is released during the final rinse to prevent water from forming droplets on your dishes that can leave spots and streaks. It also improves drying performance by allowing water to "sheet" off the dishes.

Be careful not to overfill the dispenser, because this could cause oversudsing. Wipe away any spills with a damp cloth. Don't forget to replace the cap before you close the dishwasher door.

If you have soft water, you may not need rinse aid for it may cause a white film to develop on your dishes.

Follow the rinse-aid manufacturers recommendations on rinse-aid.

Adjusting Rinse-Aid Dispenser

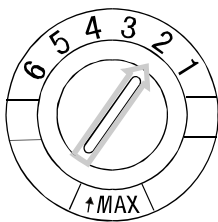

A measured amount of rinse-aid is released during the final rinse. As with detergent, the amount of rinse-aid needed for your dishes depends on the hardness of the water in your area. Too much rinse-aid can result in lather or foaming and cause cloudiness or streaks on your dishes. If the water in your area is very soft, you may not need rinse-aid. If you do, you can dilute the rinse-aid with an equal amount of water.

The rinse-aid dispenser has 6 settings. Always start with the dispenser set on "2". If spots and poor drying are problems, increase the amount of rinse aid dispensed by removing the dispenser lid and rotating the dial to "3". If the dishes still are not drying properly or are spotted, adjust the dial to the next higher number until your dishes are spot-free. We suggest you to set on "2". (Factory value is "2".)

When to Refill the Rinse Aid Dispenser

If there is no rinse aid, a warning light will appear in the display window. You can judge the amount of rinse aid by the following means. The black dot on the rinse aid dispenser indicates the amount of rinse aid in the dispenser. As the rinse aid diminishes, the size of the black dot decreases. You should never let the rinse aid get below 1/4 full.

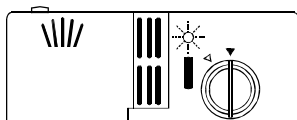

As the rinse aid diminishes, the size of the black dot on the rinse aid level indicator changes, as illustrated below.

- Full
- 3/4 full
- 1/2 full
- 1/4 full – Should refill to eliminate spotting
- Empty

HOW TO USE THE UPPER RACK(14 PLACE SETTINGS)

The upper rack is for more delicate and lighter dishware such as glasses, coffee & tea cups, saucers, plates, bowls, and shallow pans (provided these are not too dirty).

Position the dishes and cookware so that they do not get moved by the spray of water. Always place glasses, cups & bowls upside down.

NOTE:

Your dishwasher comes with an adjustable top rack (basket) pictured at right. Its height can be adjusted by lifting the handle in a downward or upward direction. (Pls see the figures on the right: position 1 & position 2.)

NOTICE:

Ensure the metal rod is located in its correct position.

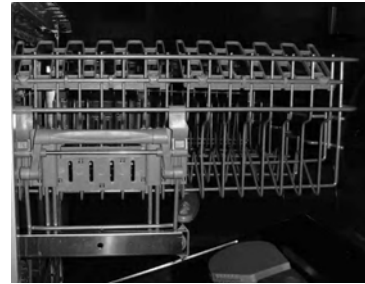

POSITION 1



POSITION 2

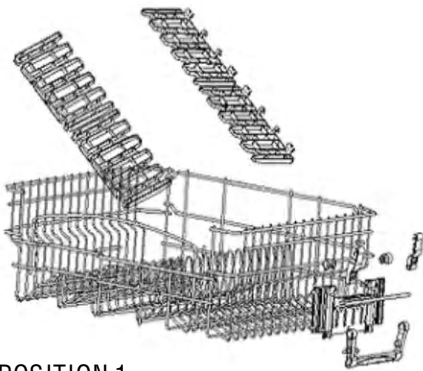

NOTE: The upper rack has side flaps (pictured at left above basket). There are 4 (2 on each side). These can be adjusted into 2 positions = position 1 (high) and position 2 (low).

To move the flaps between these positions, locate the large hinges clip each flap to the upper rack. There are two of these at either end of each flap. Gently pull both clips off the wire rack and move the flap to the desired position. be careful if you have long fingernails!

POSITION 1

The upper position will accommodate items such as glass tumblers (placed beneath flap) and wine glasses. Wine glasses can be placed upside down so that the neck rests in the grooves at side of flap with the base of the glass facing upward.

POSITION 2

When the flaps are moved to the lower position, they can be used to hold additional tumblers, cups and mugs. Always check that you are only placing items on the flaps that will clear the ceiling height of your dishwasher when you push the rack back in. Be careful with long-stemmed glassware such as champagne glasses and ensure that these are clear of the top of the dishwasher.

Loading the Dishwasher Racks(14 sets).(Loading the Upper Rack)

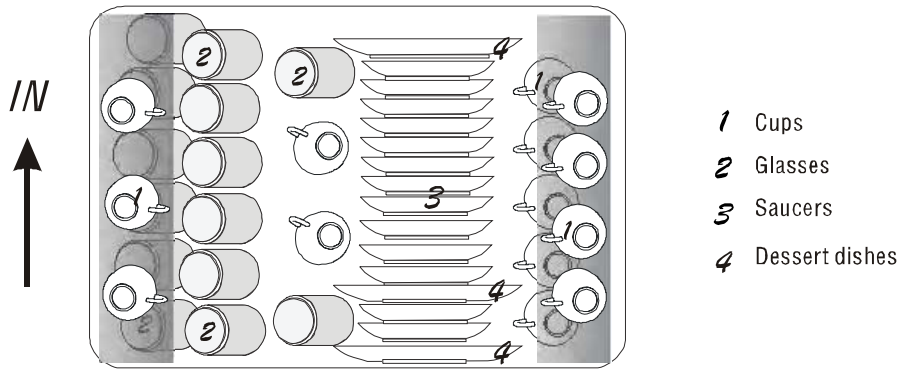

Loading the Lower Rack

We recommend that you place large items which are most difficult to clean into the lower rack: pots, pans, lids, serving dishes and bowls, as shown in the figure to the right.

It is preferable to place serving dishes and lids on the side of the racks in order to avoid blocking the rotation of the top spray arm.

- Pots, serving bowls, etc, must always be placed top down.
- Deep pots should be slanted to allow water to flow out.
- The bottom rack feature fold down tine rows so that larger or more pots and pans can be loaded.

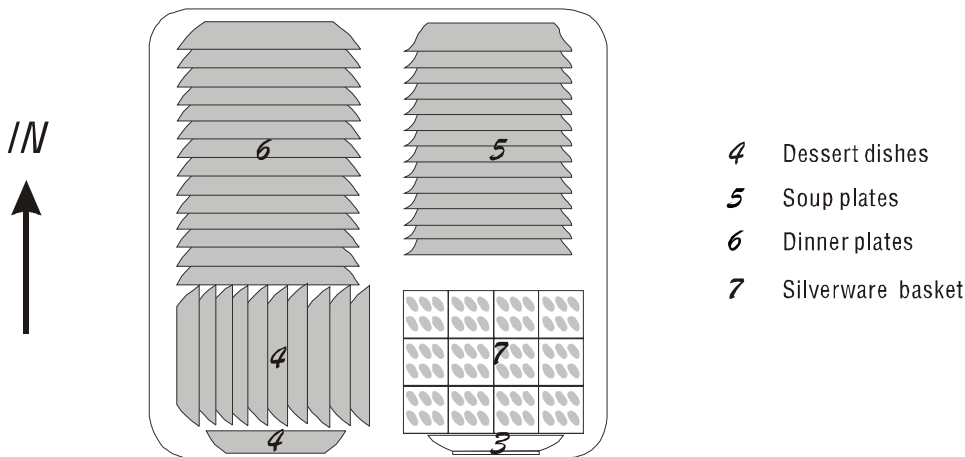

Folding spikes

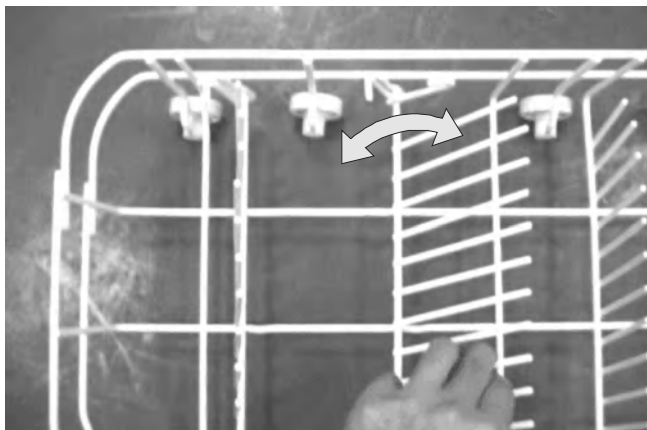

To improve stacking of pots and pans, the spikes can be folded down.

SILVERWARE BASKET

Silverware should be placed in the silverware basket with handles at the bottom: If the rack has side baskets, the spoon should be loaded individually into the appropriate slots, Especially long utensils should be placed in the horizontal position at the front of the upper rack.



2 4 2	2 4 2	2 4 2	3 3
1 4 1	1 4 1	1 4 1	5 5 3
1 4 1	1 4 1	5 5 5	5 5 5
2 4 2	2 4 3	3 3 3	3 3 3
1 4 1	1 4 1	5 5 5	5 5 5
2 4 2	2 4 2	2 3 3	3 3

- 1 Forks
- 2 Soup spoons
- 3 Dessert spoons
- 4 Teaspoons
- 5 Knife



⚠ WARNING!

Do not let any item extend through bottom.

Not suitable for the dishwasher

The following should not be cleaned in the dishwasher:

- Wooden cutlery and utensils—these will leach out and become unsightly.
- Sensitive ornamental glasses, craft utensil and vases, special antique or irretrievable utensils. These ornaments are not dishwasher-proof.
- Plastic parts sensitive to hot water.
- Utensils which are soiled with ash, wax, lubricating grease or ink.
- Absorbent materials such as sponges and cloths. Aluminium and silver parts have a tendency to discolour and fade during the wash cycle. Even some types of glass may turn cloudy after many wash cycles.
- Copper and tin utensils.

Recommendation:

In future buy utensils which identified as dishwasher-proof.

Damage to glassware and other dishers

Possible causes:

- Type of glass or manufacturing process.
- Chemical composition of detergent.
- Water temperature and duration of dishwasher programme.

Suggested remedy:

- Use glassware or porcelain dishes that have been marked 'dishwasher-proof' by the manufacturer.
- Use a mild detergent that is described as 'kind to dishes'. If necessary, seek further information from detergent manufacturers.
- Select a programme with as low a temperature.
- To prevent damage, take glass and cutlery out of the dishwasher as soon as possible after the programme has ended.

Filtering System

For your convenience, we have placed the drain pump and filtering system within easy reach inside the tub. There are three components of the filtering system: the main filter, the coarse filter, and the fine filter.

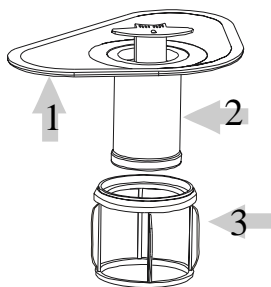

- 1 Main filter**
Food and soil particles trapped by this filter are pulverized by a special jet on the lower spray arm and washed down the drain.
- 2 Coarse filter**
Larger items, such as pieces of bone or glass, that could clog the drain are trapped in the coarse filter. To remove an item caught in this filter, gently squeeze the tabs on top of this filter and lift it out.
- 3 Fine filter**
This filter holds soil and food residue in the sump area and prevents it from being redeposited on the dishes during a cycle.

Caring for the Dishwasher

To clean the control panel use a lightly dampened cloth then dry thoroughly. To clean the exterior use a good appliance polish wax.

Never use sharp objects, scouring pads or harsh cleaners on any part of the dishwasher.

Protect Against Freezing

If your dishwasher is left in an unheated place during the winter, you should:

- 1** Cut off electrical power to the dishwasher.
- 2** Turn off the water supply and disconnect the water inlet pipe from the water valve.
- 3** Drain water from the inlet pipe and water valve.
(Use a pan to catch the water.)
- 4** Reconnect the water inlet pipe to the water valve.
- 5** Remove the filter in the tub the bottom and use a sponge to soak up water in sump.

Cleaning the Spray Arms

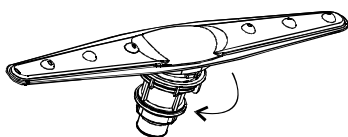

It is necessary to clean the spray arms regularly, for hard water chemicals will clog the spray arm jets and bearings. To remove the spray arm, screw off the nut clockwise to take out the washer on top of the spray arm and remove the arm. Wash the arms in soapy and warm water and use a soft brush to clean the jets. Replace them after rinsing them thoroughly.

Cleaning the Filters

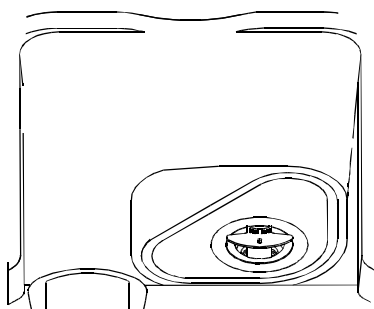

Filter assembly

For best performance and results, the filter assembly must be cleaned. The filter efficiently removes food particles from the wash water, allowing it to be recirculated during the cycle. For this reason, it is a good idea to remove the larger food particles trapped in the filter after each wash cycle by rinsing the semicircular filter and cup under running water. To remove the filter assembly, pull on the cup handle in the upward direction. The entire filter assembly should be cleaned once a week.

To clean the coarse filter and the fine filter, use a cleaning brush. Then, reassemble the filter parts as shown in the figures left and reinsert the entire assembly in the dishwasher, positioning in its seat and pressing downward.

▲ WARNING!

The dishwasher must never be used without the filters in place. Improper replacement of the filter may reduce the performance level of the appliance and cause damage to the appliance. When cleaning the filters do not 'knock' or use excessive force to clean the filters as if the filters are bent in anyway the performance of the dishwasher may be effected.

Cleaning the Door

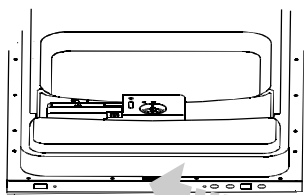

To clean the edge around the door, you should use only a soft warm, damp rag. To prevent penetration of water into the door lock and electrical components, do not use a spray cleaner of any kind.

Also, never use abrasive cleaners or scouring pads on the outer surfaces because they will scratch the finish. Some papers towels can also scratch or leave marks on the surface.

⚠ WARNING!

Never use a spray cleaner to clean the door panel for it could damage the door lock and electrical components. It is not allowed to use the abrasive agent or some paper towel because of the risk of scratching or leaving spots on the stainless steel surface.

How to Keep Your Dishwasher in Shape

■ *After Every Wash*

After every wash, turn off the water supply to the appliance and leave the door slightly ajar so that moisture and odors are not trapped inside.

■ *Remove the Plug*

Before cleaning or performing maintenance, always remove the plug from the socket. Do not run risks.

■ *No Solvents or Abrasive Cleaning*

To clean the exterior and rubber parts of the dishwasher, do not use solvents or abrasive cleaning products. Rather, use only a cloth and warm soapy water. To remove spots or stains from the surface of the interior, use a cloth dampened with water and a little white vinegar, or a cleaning product made specifically for dishwashers.

■ *When You Go on Holiday*

When you go on holiday, it is recommended that you run a wash cycle with the dishwasher empty and then remove the plug from the socket, turn off the water supply and leave the door of the appliance slightly ajar. This will help the seals last longer and prevent odors from forming within the appliance.

■ *Moving the Appliance*

If the appliance must be moved, try to keep it in the vertical position. If absolutely necessary, it can be positioned on its back.

■ *Seals*

One of the factors that cause odors to form in the dishwasher is food that remains trapped in the seals. Periodic cleaning with a damp sponge will prevent this from occurring.

Electrical Connection

⚠ CAUTION, for personal safety:

DO NOT USE AN EXTENSION CORD OR ADAPTER PLUG WITH THIS APPLIANCE.

DO NOT, UNDER ANY CIRCUMSTANCES, CUT OR REMOVE THE THIRD GROUNDING PRONG FROM THE POWER CORD.

Electrical Requirements

Please see the rating label to know the rating voltage and connect the dishwasher to the appropriate power supply, a 10 amp fused circuit is required with copper wire only. A separate circuit with a circuit breaker serving only this appliance is recommended. The power outlet should be placed in an adjacent cabinet.

Electrical Connection

After making sure that the voltage and the frequency values for the current in the home correspond to those on the rating plate and that the electrical system is sized for the maximum voltage on the rating plate, insert the plug into an electrical socket which is earthed properly. If the electrical socket to which the appliance must be connected is not appropriate for the plug, replace the socket, rather than using an adaptor or the like as they could cause overheating and burns.

⚠ Insure proper ground exists before use

Cold Water Connection

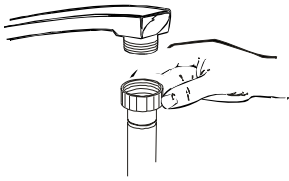

Connect the cold water supply hose to a threaded 3/4 (inch) connector and make sure that it is fastened tightly in place.

If the water pipes are new or have not been used for an extended period of time, let the water run to make sure that the water is clear and free of impurities. If this precaution is not taken, there is a risk that the water inlet can get blocked and damage the appliance.

Hot Water Connection

The water supply to the appliance can also be connected to the house hot water line (centralized system, heating system), as long as it does not exceed a temperature of 60°C. In this case, the wash cycle time will be shortened by about 15 minutes and the wash efficiency slightly reduced.

The connection must be made to the hot water line following the same procedures as those for the connection to the cold water line.

Positioning the Appliance

Position the appliance in the desired location. The back should rest against the wall behind it, and the sides, along the adjacent cabinets or wall. The dishwasher is equipped with water supply and drain hoses that can be positioned to the right or the left to facilitate proper installation.

Levelling the Appliance

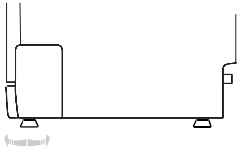

Once the appliance is positioned, adjust the feet (screwing them in or out) to adjust the height of the dishwasher, making it level. In any case, the appliance should not be inclined more than 2°.

Drain hose Connection

Insert the drain hose into a drain pipe with a minimum diameter of 40 mm, or let it run into the sink, making sure to avoid bending or crimping it. Use the special plastic support that attached with the appliance. The free end of the hose must be at a height between 400 and 1000mm and must not be immersed in water.

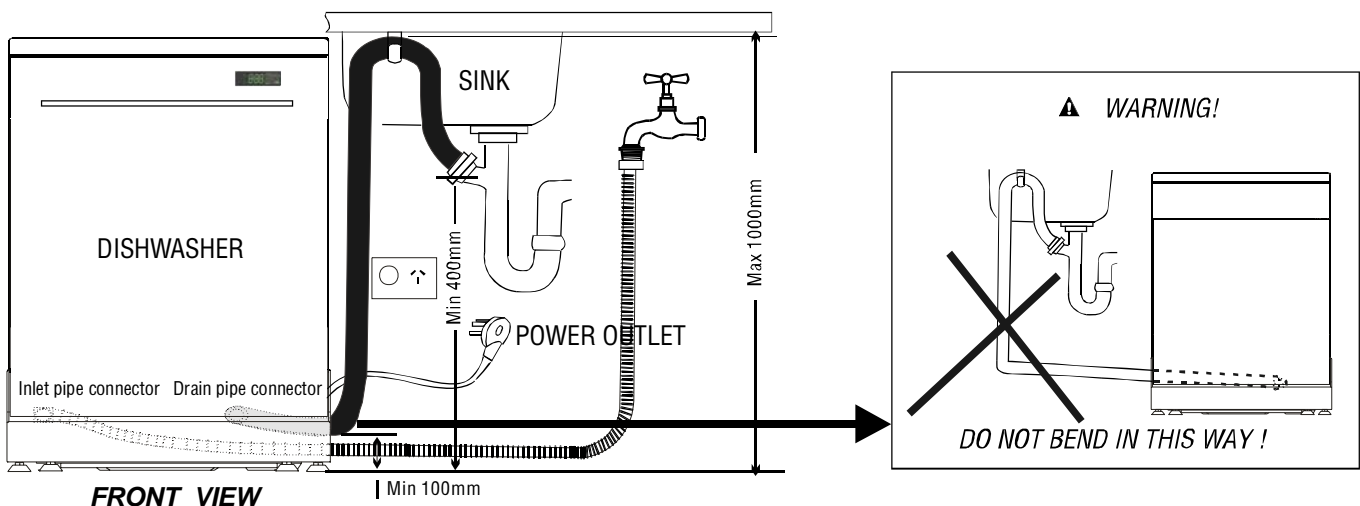

How to Drain Excess Water From Hoses

If the sink is 1000 higher from the floor, the excess water in hoses cannot be drained directly into the sink. It will be necessary to drain excess water from hoses into a bucket or suitable container that is held outside and lower than the sink.

⚠ WARNING!

In order to avoid more water staying in the inlet hose, please close the hydrant after using. (For the models: no safety inlet hose.)

Before Calling for service . . .

Troubleshooting Tips

Review the charts on the following pages may make you be free of calling for service.



<i>Problem</i>	<i>Possible Causes</i>	<i>What To Do</i>
<i>Dishwasher doesn't run</i>	Fuse blown, or the circuit breaker acted	Replace fuse or reset circuit breaker. Remove any other appliances sharing the same circuit with the dishwasher
	Power supply is not turned on	Make sure the dishwasher is turned on and the door is closed securely. Make sure the power cord is properly plugged into the wall socket.
	Water pressure is low	Check that the water supply is connected properly and the water is turned on.
<i>Drain pump doesn't stop</i>	Overflow	The system is designed to detect an overflow. When it does, it shuts off the circulation pump and turns on the drain pump.
<i>Noise</i>	Some audible sounds are normal	Sound from soft food shredding action and detergent cup opening.
	Utensils are not secure in the baskets or something small has dropped into the basket	To ensure everything is secured in the dishwasher.
	Motor hums	Dishwasher has not been used regularly. If you do not use it often, remember to set it to fill and pump out every week, which will help keep the seal moist.
<i>Suds in the tub</i>	Improper detergent	Use only the special dishwasher detergent to avoid suds. If this occurs, open the dishwasher and let suds evaporate. Add 4 litres of cold water to the tub. Close and latch the dishwasher, then drain out the water by slowly turning the Dial until a drain period is reached. Repeat if necessary.
	Spilled rinse agent	Always wipe up rinse agent spills immediately.
<i>Stained tub interior</i>	Detergent with colorant was used	Make sure that the detergent is the one without colorant.
<i>Dishes are not dried</i>	Rinse agent dispenser is empty	Make sure that the rinse agent dispense is filled.
<i>Dishes and flatware not clean</i>	Improper program	Select stronger program
	Improper rack loading	Make sure that the action of the detergent dispenser and spray arms are not blocked by large dishware.
<i>Spots and filming on glasses and flatware</i>	<ul style="list-style-type: none"> 1 Extremely hard water 2 Low inlet temperature 3 Overloading the dishwasher 4 Improper loading 5 Old or damp powder detergent 6 Empty rinse agent dispenser 7 Incorrect dosage of detergent 	<p>To remove spots from glassware:</p> <ul style="list-style-type: none"> 1 Take out all metal utensils out of the dishwasher. 2 Do not add detergent. 3 Choose the longest cycle. 4 Start the dishwasher and allow it to run for about 18 to 22 minutes, then it will be in the main wash. 5 Open the door to pour 2 cups of white vinegar into the bottom of the dishwasher. 6 Close the door and let the dishwasher complete the cycle. If the vinegar does not work: Repeat as above, except use 1/4 cup (60 ml) of citric acid crystals instead of vinegar.

Before calling for service . . .

<i>Problem</i>	<i>Possible Causes</i>	<i>What To Do</i>
<i>Cloudiness on glassware</i>	Combination of soft water and too much detergent	Use less detergent if you have soft water and select a shortest cycle to wash the glassware and to get them clean.
<i>Yellow or brown film on inside surfaces</i>	Tea or coffee stains	using a solution of 1/2 cup of bleach and 3 cups warm water to remove the stains by hand. ⚠ WARNING You have to wait for 20 minutes after a cycle to let the heating elements cool down before cleaning interior; otherwise, burns will happen.
	Iron deposits in water can cause an overall film	You have to call a water softener company for a special filter.
<i>White film on inside surface</i>	Hard water minerals	To clean the interior, use a damp sponge with dishwasher detergent and wear rubber gloves. Never use any other cleaner than dishwasher detergent for the risk of foaming or suds.
<i>Detergent left in dispenser cups</i>	Dishes block detergent cups	Re-loading the dishes properly.
<i>Steam</i>	Normal phenomenon	There is some steam coming through the vent by the door latch during drying and water draining.
<i>Black or gray marks on dishes</i>	Aluminum utensils have rubbed against dishes	Use a mild abrasive cleaner to eliminate those marks.
<i>Water standing in the bottom of the tub</i>	This is normal	A small amount of clean water around the outlet on the tub bottom at the back of the tub keeps the water seal lubricated.
<i>Dishwasher leaks</i>	Overfill dispenser or rinse aid spills	Be careful not to overfill the rinse aid dispenser. Spilled rinse aid could cause oversudsing and lead to overflowing. Wipe away any spills with a damp cloth.
	Dishwasher isn't level	Make sure the dishwasher is level.

Fault codes

<i>Codes</i>	<i>Meanings</i>	<i>Possible Causes</i>
<i>E1</i>	Longer inlet time.	The tap is not opened.
<i>E3</i>	Longer heating time, but not reaching required temperature	Malfunction of temperature sensor or of heating element.
<i>E4</i>	Overfilled.	Too much inlet water.
<i>E6,E7</i>	Abnormal temperature	Short circuit or break of temperature sensor.

Technical information

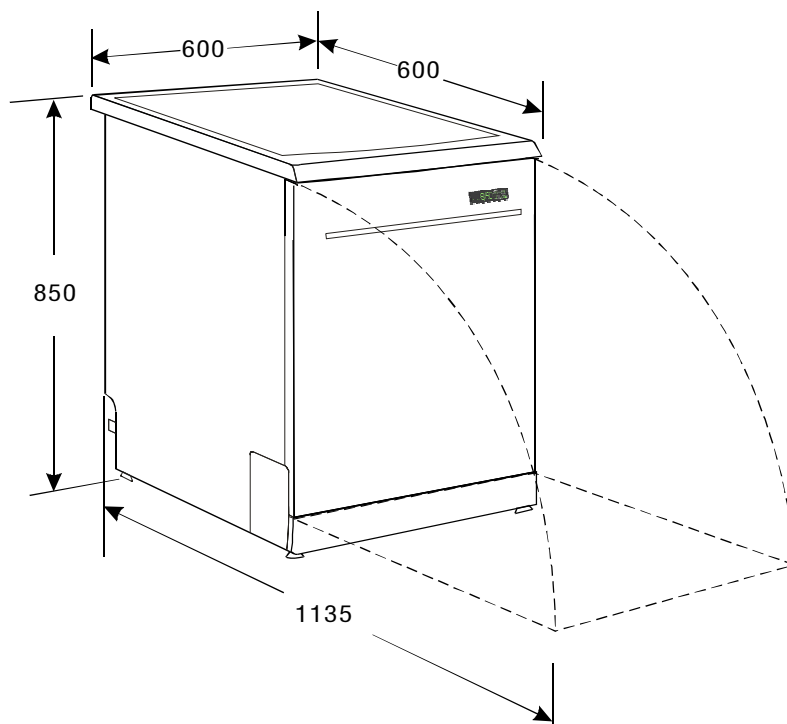

Height :	850mm
Width :	600mm
Depth :	600mm
Voltage connected Load :	see rating label
Water pressure:	0.04-1.0MPa
Hot water connection :	max 60 °C
Power supply:	230-240V ~ 50Hz
Capacity:	14 Place settings