

Thinking of you

 **Electrolux**

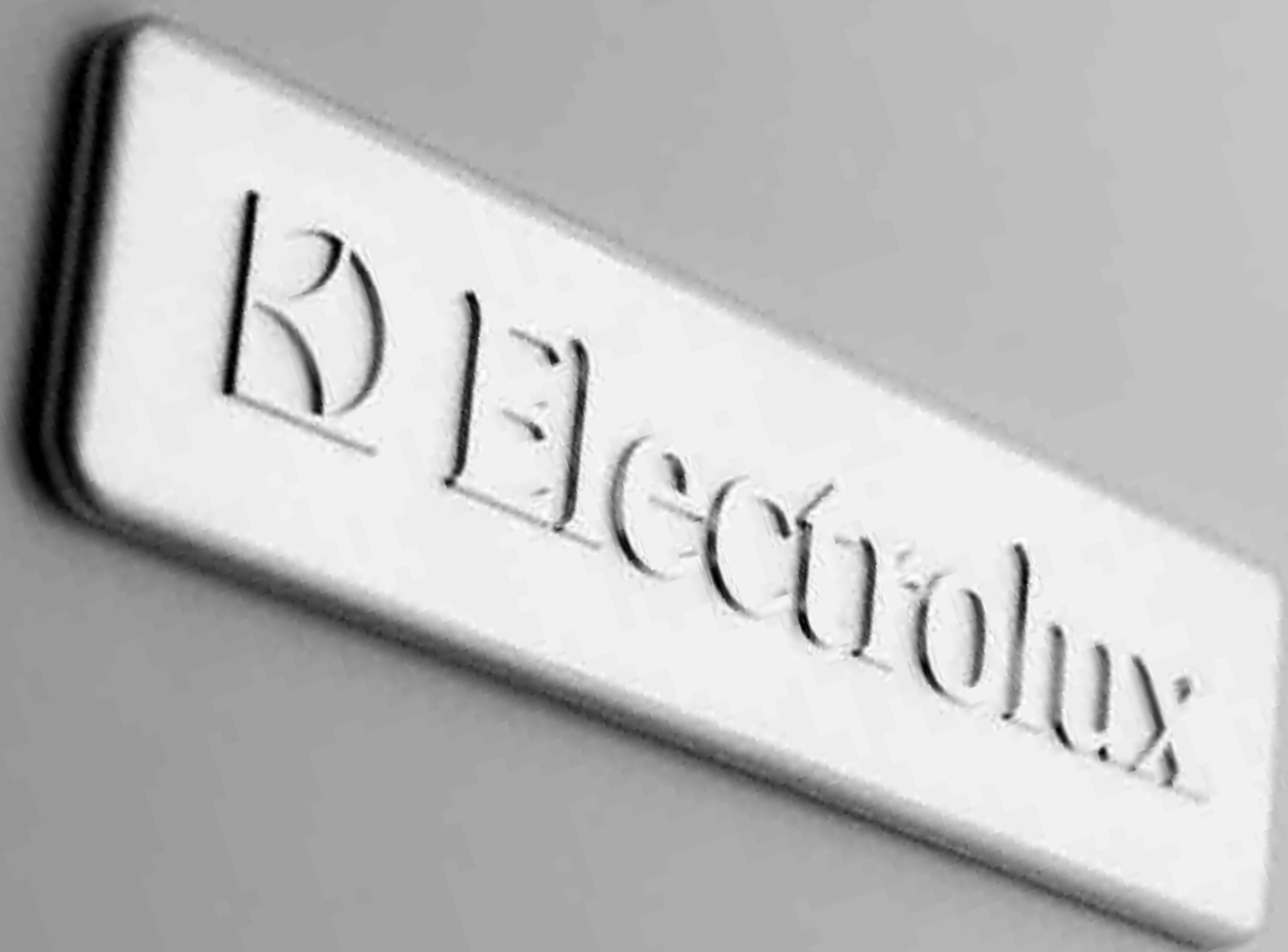

user manual

refrigeration

*top mounts, bottom mounts,
single door all refrigerator,
single door all freezer,
built-in refrigerator, built-in freezer*

Congratulations

Congratulations and thank you for choosing our products. We are sure you will find your new appliance a pleasure to use. Before you use the appliance, we recommend that you read through the entire user manual, which provides the description of the appliance and its functions.

To avoid the risks that are always present when you use an electric appliance, it is important that the appliance is installed correctly and that you read the safety instructions carefully to avoid misuse and hazards.

We recommend that you keep this instruction booklet for future reference and pass it on to any future owners. After unpacking the appliance please check it is not damaged. If in doubt, do not use the appliance but contact your local Electrolux Customer Care Centre.



Contents

• Top mount freezer model features	ii
• Bottom mount freezer model features	ii
• Single door all refrigerator model features	iii
• Single door all freezer model features	iii
• Built-in refrigerator model features	iv
• Built-in freezer model features	iv
• Important safety instructions	1
• Installing your new appliance	2
• Initial start up	3
• Electronic display controls – electronic models only	4
– Controlling the temperature	4
– Freezer temperature alarm	4
– Door alarm	4
– Child lock	4
– Drinks chill timer	4
– Energy efficiency	5
• Manual (rotary) controls – manual models	6
• Using your appliance	6
– Crisper bin	6
– Door storage bins	7
– Dairy compartment	7
– Chiller bin	7
– Modula bottle caddy	7
– Freezer drawers	7
– Freezer baskets	7
– Spillsafe™ glass shelves	8
– Slide away glass shelf	8
– Deodoriser	8
– Bottle twist holder	8
– Twist ice & serve	9
– Ice station	9
• Care and maintenance	9
– Changing the lightbulb	9
– Cleaning the appliance	9
• General information	10
– Safety	10
• Troubleshooting	11
• Warranty	12



environmental tip

Information on disposal for users

- Most of the packing materials are recyclable. Please dispose of those materials through your local recycling depot or by placing them in appropriate collection containers.
- If you wish to discard this product, please contact your local authorities and ask for the correct method of disposal.

Top mount freezer model (TM)

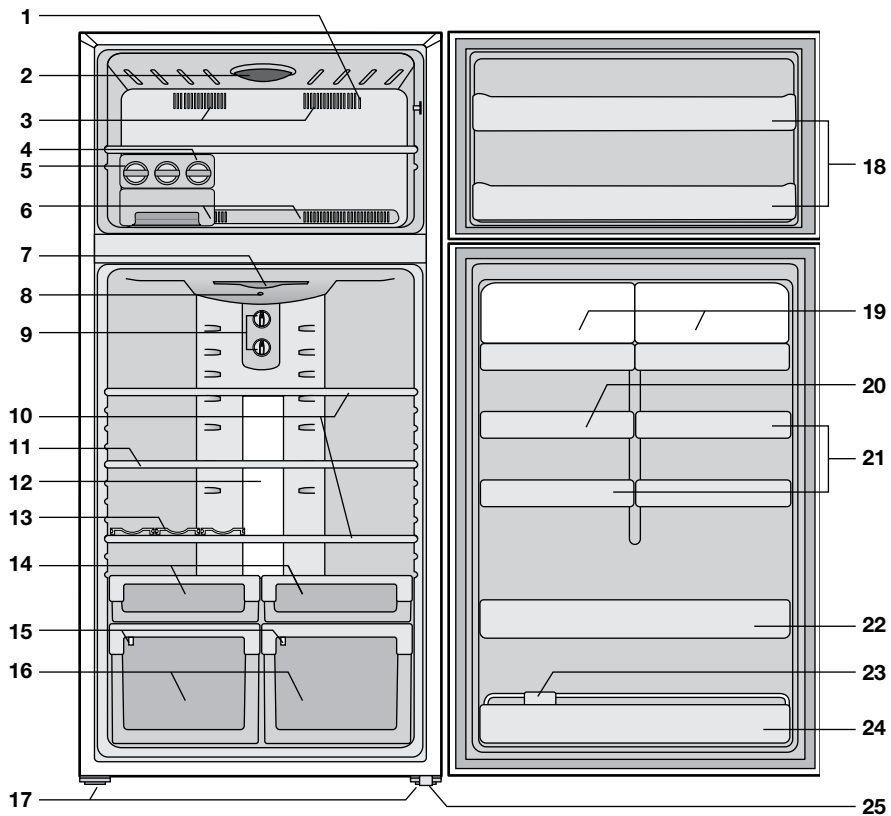

- 1 Sensor (electronic models only)
- 2 Freezer light (electronic models only)
- 3 Freezer air delivery vents
- 4 Adjustable Spillsafe™ glass shelf
- 5 Twist ice & serve with ice cube trays
- 6 Freezer air return vents
- 7 Sensor (electronic models only)
- 8 Deodoriser
- 9 Fridge and freezer temperature controls (manual control models)
- 10 Adjustable Spillsafe™ glass shelves
- 11 Spillsafe™ slide away shelf (where fitted)
- 12 Fridge light
- 13 Modula bottle caddy
- 14 Deli compartments (full width on some models)
- 15 Crisper humidity controls
- 16 Crisper bins (full width on some models)
- 17 Adjustable rollers
- 18 Freezer door bins
- 19 Dairy compartments
- 20 Egg tray
- 21 Adjustable door bins
- 22 Full width door bin
- 23 Bottle twist holder (where fitted)
- 24 Full width door bin (can bin on smaller models)
- 25 Stabilising foot

Note: Product illustrations demonstrate various features but may not be completely in line with current products.

Bottom mount freezer model (BM)

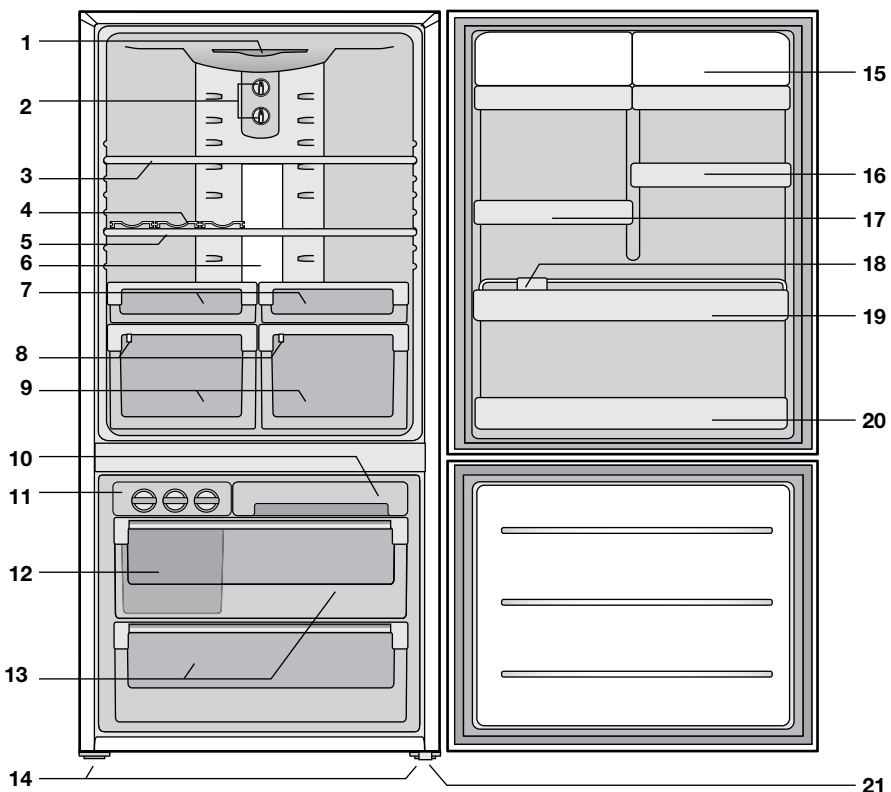

- 1 Deodoriser
- 2 Fridge and freezer temperature controls (manual control models)
- 3 Spillsafe™ slide away shelf (where fitted)
- 4 Modula bottle caddy
- 5 Adjustable Spillsafe™ glass shelf
- 6 Fridge light
- 7 Deli compartments (full width on some models)
- 8 Crisper humidity controls
- 9 Crisper bins (full width on some models)
- 10 Freezer storage tray
- 11 Twist & serve ice
- 12 Ice bin with scoop (inside freezer drawer)
- 13 Freezer drawers on telescopic extension slides
- 14 Adjustable rollers
- 15 Dairy compartments
- 16 Adjustable door bins
- 17 Egg tray
- 18 Bottle twist holder (where fitted)
- 19 Full width bottle bin
- 20 Full width bottle bin (can bin on smaller models)
- 21 Stabilising foot

Note: Product illustrations demonstrate various features but may not be completely in line with current products.

Single door all refrigerator model (AR)

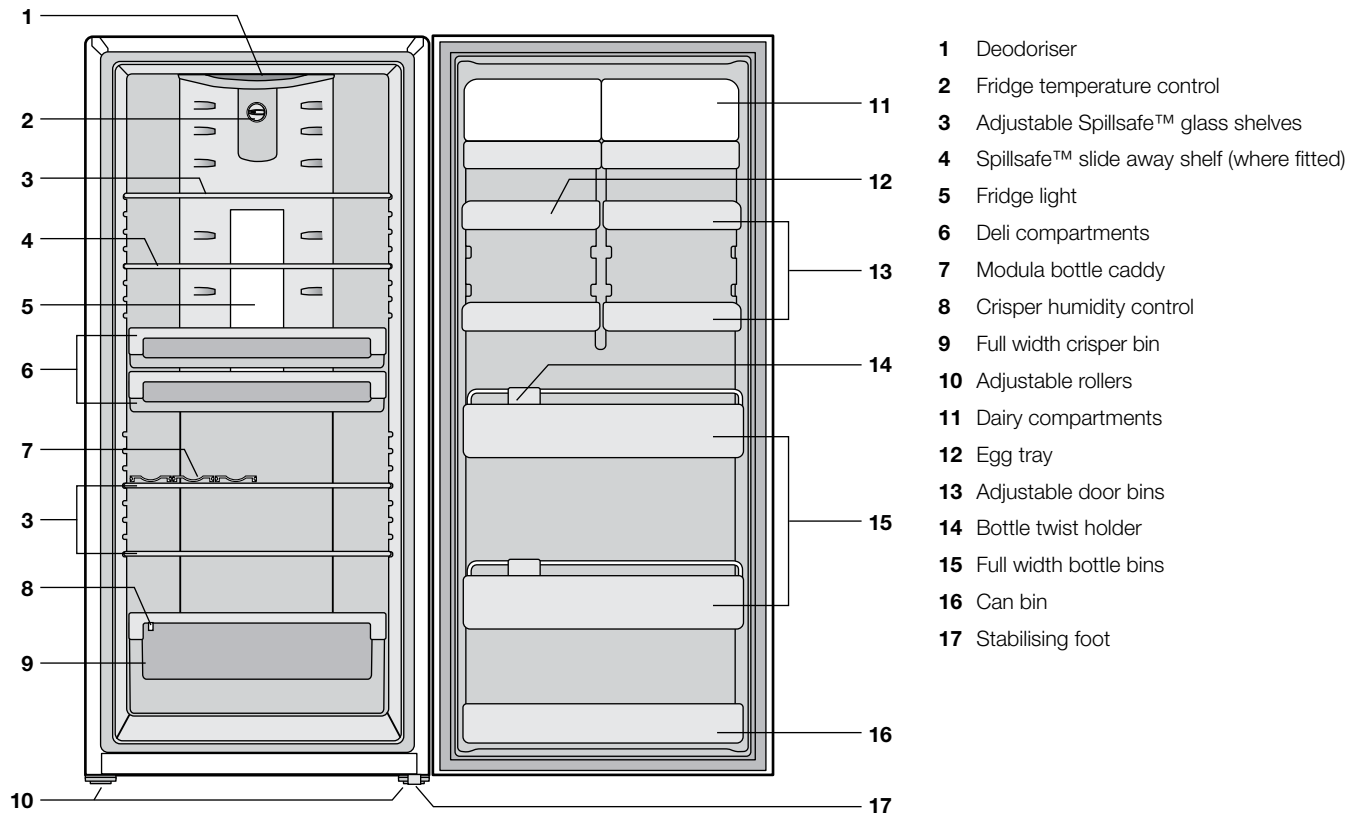

Note: Product illustrations demonstrate various features but may not be completely in line with current products.

Single door all freezer model (AF)

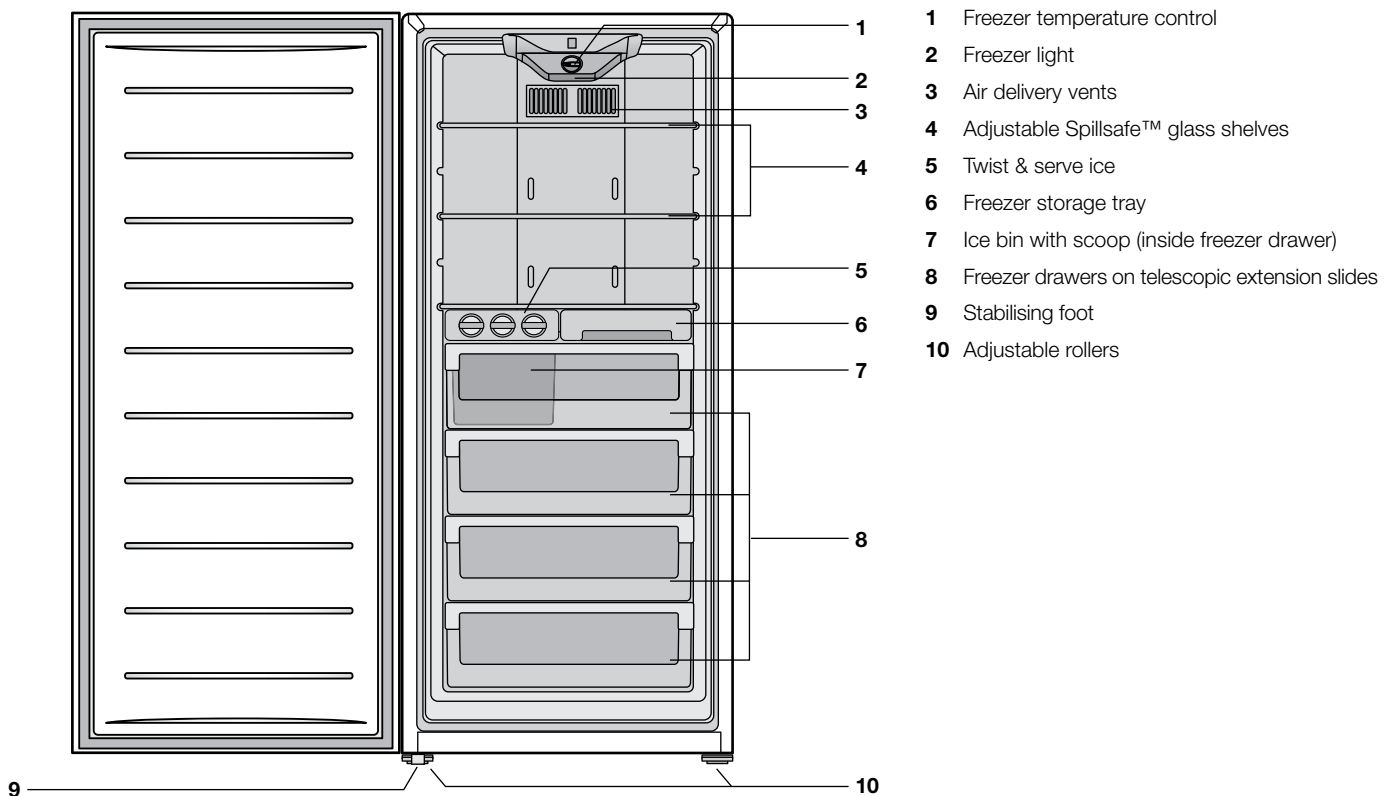

Note: Product illustrations demonstrate various features but may not be completely in line with current products.

Built-in refrigerator

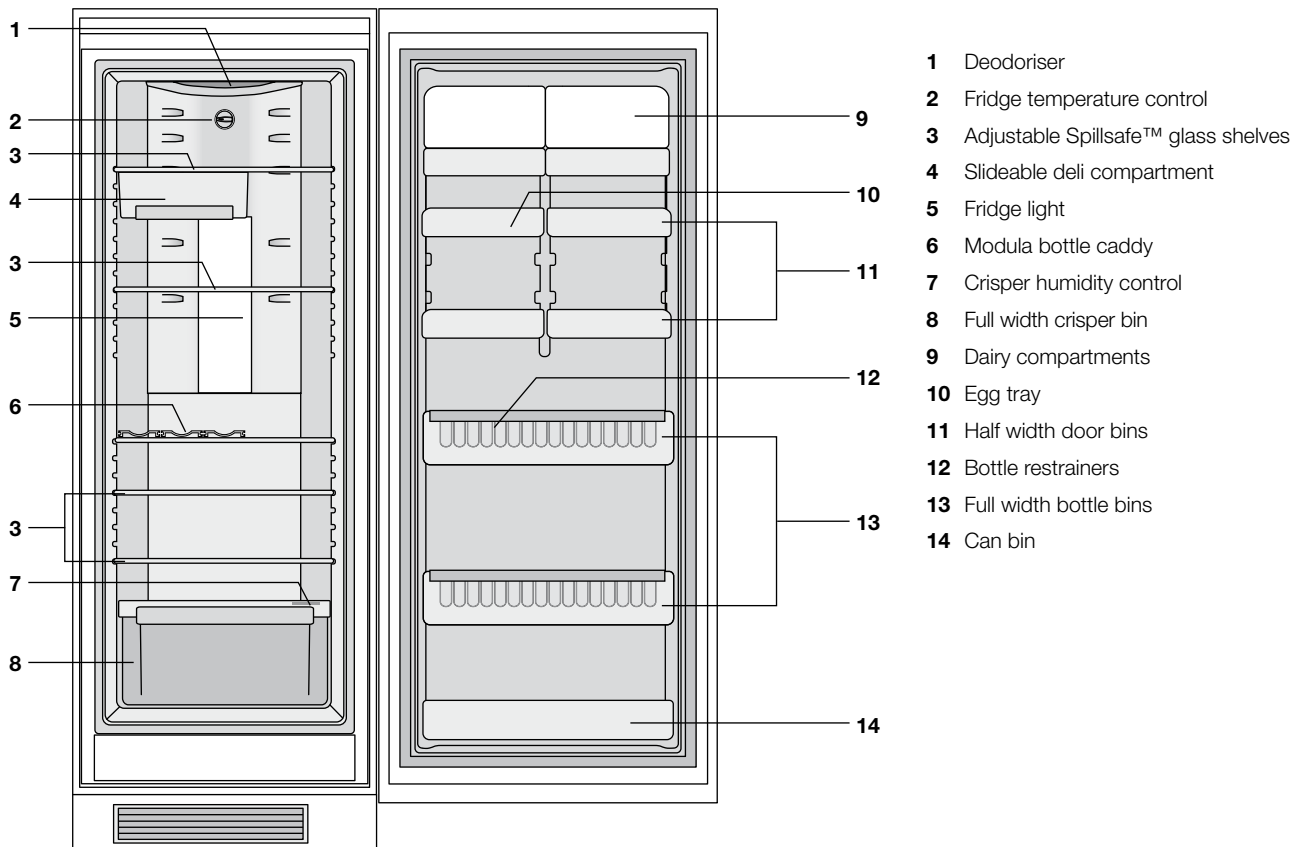

Note: Product illustrations demonstrate various features but may not be completely in line with current products.

Built-in freezer

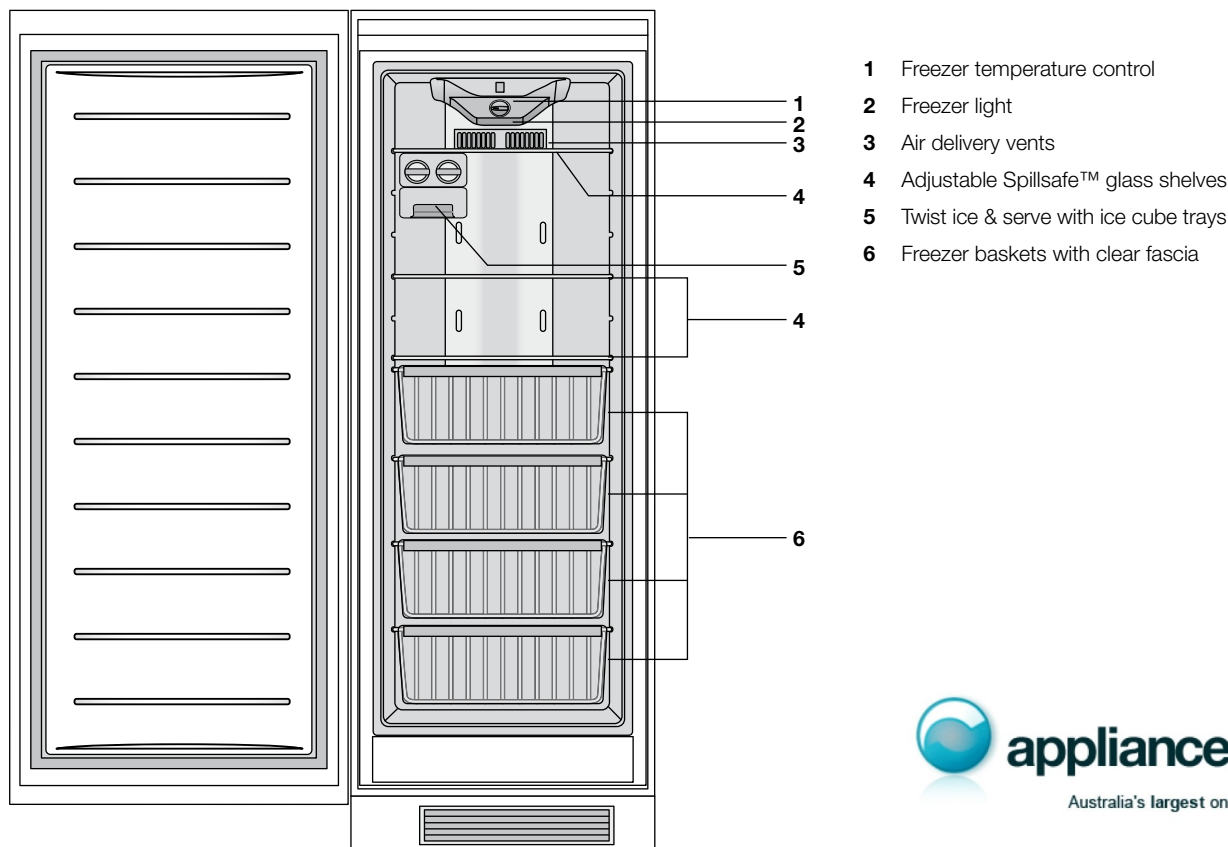

Note: Product illustrations demonstrate various features but may not be completely in line with current products.

Important safety instructions

Please read the user manual carefully and store in a handy place for later reference.

The symbols you will see in this booklet have these meanings:



warning

This symbol indicates information concerning your personal safety



caution

This symbol indicates information on how to avoid damaging the appliance



tips and information

This symbol indicates tips and information about use of the appliance



environmental tip

This symbol indicates tips and information about economical and ecological use of the appliance

Meanings of symbols used in this manual are shown below:

This symbol indicates never to do this

This symbol indicates always do this



warning

Stability foot

When your refrigerator is in place, wind down the stability foot to the floor to stabilise it. Lift the front of the refrigerator to take the weight off the stability foot, then turn it ¼ turn further to ensure firm contact with the floor. If you do move the refrigerator, remember to wind it back up, to allow the refrigerator to roll. Remember to reset it when reinstalling.

side view

Stabilising foot wound down

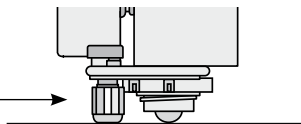

front view

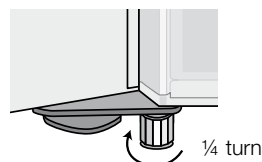

warning

This appliance is not intended for use by persons (including children) with reduced physical, sensory or mental capabilities, or lack of experience and knowledge, unless they have been given supervision or instruction concerning use of the appliance by a person responsible for their safety.

Children should be supervised to ensure that they do not play with the appliance.



warning

- The refrigerator must be plugged into its own dedicated 220-240V, 50Hz AC electrical outlet.
- The plug must be accessible when the refrigerator is in position.
- It is essential the power point is properly earthed to ground. Consult a qualified electrician if you are unsure.
- Don't use extension cords or adapter plugs with this refrigerator.
- If the power cord is damaged, have it replaced by a qualified service technician.
- Unplug the refrigerator before cleaning it, or changing the light bulb to avoid electric shock.
- Never unplug the refrigerator by pulling the electrical cord as this may damage it. Grip the plug firmly and pull straight out.
- Choose a location for your refrigerator that isn't too cold. The ambient room temperature should be above 10°C.
- Stand your refrigerator in a dry place – avoid areas of high moisture or humidity.
- Don't put the refrigerator in frosty or unprotected areas like a garage or on the verandah.
- Keep the refrigerator out of direct sunlight.
- Don't locate the refrigerator near stoves, fires or heaters.
- When installed correctly, your refrigerator should:
 - Have adequate space at the back and sides for air circulation (refer to page 2).
 - Be aligned to the surrounding cupboards.
 - Have doors that will self-close from a partially open position.
- Keep ventilation openings in the appliance enclosure or in the built-in structure clear of obstruction.
- When transporting and installing the refrigerator, care should be taken to ensure that no parts of the refrigerating circuit are damaged.



warning

- If pressurised aerosol containers bear the word 'flammable' and/or a small flame symbol, do not store them inside any refrigerator or freezer. If you do so you may cause an explosion. 
- When you dispose of your old refrigerators and freezers, remove any doors. Children can suffocate if they get trapped inside.
- This appliance contains insulation formed with flammable blowing gases. Avoid safety hazards by carefully disposing of this appliance.
- Don't use a steam cleaner. If live components come into contact with condensing steam, they may short-circuit or cause an electric shock.

R600a refrigerant warning

This appliance contains a small quantity of environmentally friendly, but flammable, non-synthetic R600a refrigerant:

- Ensure that the tubing of the refrigerant circuit is not damaged during transportation and installation.
- Leaking refrigerant may cause eye injuries or ignite.
- The room for installing appliances must be at least 1m³ per 8g of refrigerant. The amount of refrigerant in the appliance can be found on the rating plate inside the appliance.

Installing your new appliance

tips and information

- For built-in models, refer to the separate booklet.
- To join two E:Line modular fridges together, refer to the booklet with the connection kit.

Adequate ventilation around your refrigerator.

The diagram below shows the recommended airspace to allow for ventilation of your refrigerator.

If you don't have a cupboard with a rear gap, the recommended clearance area on top increases from 50mm to 90mm (x) and from 32mm to 72mm (y). When positioned in a corner area, spacing of at least 350mm on the hinge side will allow the doors to open enough to enable the removal of bins and shelves.

Note: For those models with telescopic extension slide-out bins, the clearance required increases from 350mm to 550mm for top mount and bottom mount models, and to 450mm for the all refrigerator model to allow full access to the bins' contents as well as bin removal.

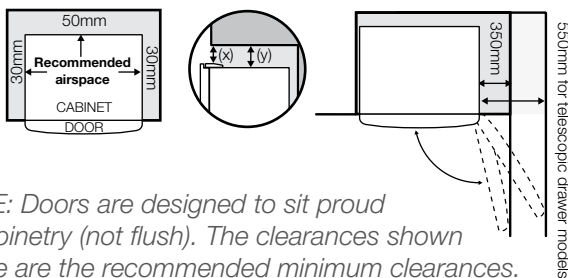

NOTE: Doors are designed to sit proud of cabinetry (not flush). The clearances shown above are the recommended minimum clearances. The clearance at the rear must not exceed 75mm.

caution

Automatic aerosol systems (such as insect control) should not be located adjacent to the product as the spray may cause long term damage to the external plastics of the appliance.

Installing your refrigerator

Your new refrigerator should arrive with the front adjustable rollers wound down, to tilt the top backwards by about 10mm from upright. This will allow your refrigerator door to self-close, providing a consistent closed seal.

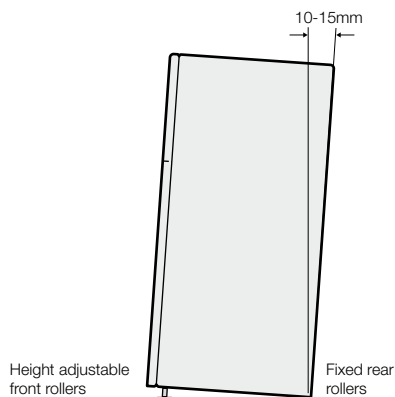

The stability foot should also be wound fully up so it will not interfere with the operation of the rollers (see diagram in Step 3).

caution

The rollers are designed for forward or backward movement only. They are not castors. Moving the refrigerator sideways may damage your floor and the rollers.

1. Roll the refrigerator into place.
2. The top of the refrigerator should be tilted back by 10mm (see diagram on left). This will allow the doors to self-close providing a consistent door seal.
3. If the refrigerator isn't tilted back, you can adjust the two front rollers by turning the large, plastic roller nut. (see diagram below). One turn of the nut increases the height of the refrigerator by 10mm. If you have difficulty turning the roller nut, have someone tilt the refrigerator back, so you have better access. Alternatively, you can access the rollers from the side, using a flat screwdriver. (See diagram below).

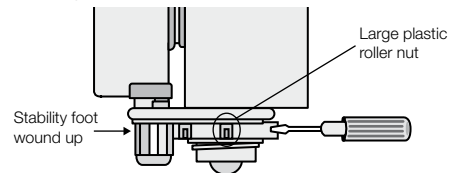

4. Check the alignment of the refrigerator to the surrounding cupboards to see if it is level. You can adjust the level with the rollers as detailed in step 3.

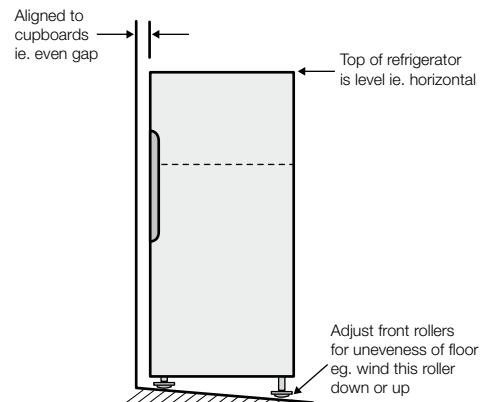

5. If you find your refrigerator rocks from corner to corner, it means your floor is uneven. Find a piece of plastic or hardboard etc. and pack it firmly under the roller.
6. On certain floor surfaces the refrigerator may roll forward during operation. A "Roller Stop", which is provided, can be placed under the front rollers.

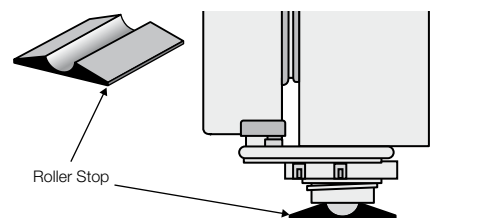

7. You may now need to fine-tune the installation by repeating Steps 3, 4 and 5.

8. When you have the appliance in its final position, it needs to be stabilised. Wind the stability foot down to the floor until it just makes contact with the floor. Lift the front of the appliance to take the weight off the stability foot, then turn it ¼ turn further to ensure firm contact with the floor. Whenever you need to move the appliance, be sure to wind the foot back up so that the appliance can roll freely and be sure to reset it when reinstalling.

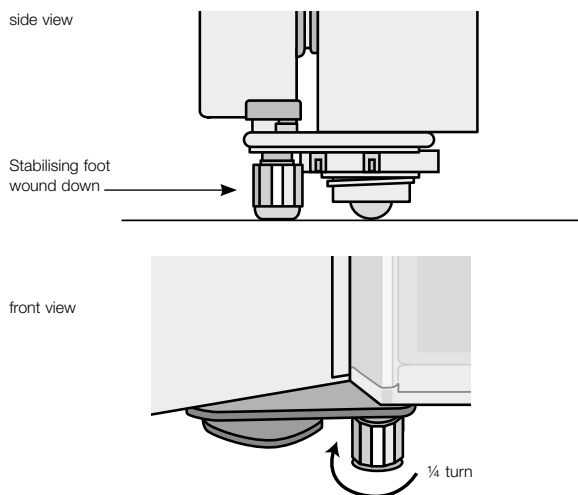

9. Clean your refrigerator thoroughly following the instructions on page 11 and wipe off any dust that has accumulated during shipping.
10. Plug your refrigerator straight into its own power point and never use a double adapter. If you need to roll the refrigerator to get to the plug, remember to raise the stability foot first.
11. Before you put any food in your refrigerator, it's recommended you leave it on for 2 or 3 hours to check it is running properly.

Congratulations! You have successfully installed your new refrigerator.

i tips and information

For built in model, the plug must be accessible after installation.

Initial start-up

Refrigerators work by transferring heat from the food inside to the outside air. This operation makes the back and sides of the refrigerator (particularly at start-up) feel warm – which is normal.

A cooling coil is located behind the rear wall of the freezer section (in top mount, bottom mount and freezer models) and behind the crisper in the all-refrigerator models. This coil cools and removes moisture from the air inside.

Avoid placing food against the air vents in the refrigerator, as it affects the efficient circulation. If the door is opened frequently, a light frosting will occasionally occur on the freezer's interior. This is normal and will clear after a few days. If the freezer door is accidentally kept open, a heavy frost will coat the inside walls and should be removed.

Your new refrigerator uses a high-speed compressor, along with other energy-efficient components, which may make unusual sounds. These sounds simply indicate your refrigerator is working how it should. They include:

- Compressor running noises;
- Air movement noise from the small fan motor;
- A gurgling sound, similar to water boiling;
- A popping noise, heard during automatic defrosting; and
- A clicking noise, prior to compressor start-up.

Further details can be found on page 10.

i tips and information

- For top mount refrigerators. (Where the freezer is on top of the fresh food compartment)
 - Don't place food forward of the ribs on the freezer floor, as it will keep the door open.

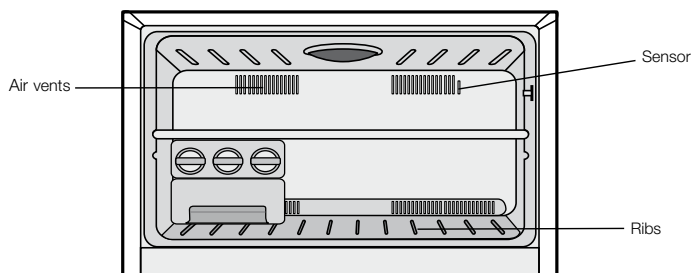

- For bottom mount refrigerators (where the freezer is below the fresh food compartment), single door refrigerators and single door vertical freezers.
 - Ensure all freezer drawers and shelves are pushed back completely to prevent them from keeping the door open.

Electronic display controls – Electronic models

The electronic display panel consists of an LCD display with white backlighting and 6 touch buttons. When the power is first turned on, the display with backlighting will come on. If no buttons have been pressed and the fridge door is closed the backlighting will turn off after 30 seconds.

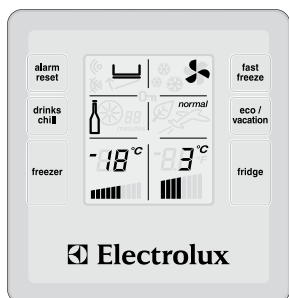

NOTE: If no buttons have been pressed for approximately 60 seconds, there may be a delay of up to 2 seconds before the display reacts. This is normal and is to prevent accidental changes to settings.

Controlling the temperature

We recommend that when you start your refrigerator for the first time, the temperature for the refrigerator is set to 3°C and the freezer to -18°C. If you want to change the temperature, follow the instructions below. Make only small adjustments and wait 24 hours to see if it's correct. Checking the softness of ice cream is a good indication if your freezer is the right temperature, while feeling the coldness of water kept in the refrigerator is a good way of checking the temperature of the food compartment.

NOTE: When you set a temperature, you set an average temperature for the whole refrigerator cabinet. Temperatures inside each compartment may vary, depending on how much food you store and where you place it. High or low room temperature may also affect the actual temperature inside the refrigerator.

Changing the freezer temperature



Press the freezer button to make the freezer colder in 1°C steps. Once the maximum of -23°C is reached, the display will return to -14°C with the next press of the button. The bar graph gets smaller with colder freezer settings.

Changing the refrigerator temperature



Press the fridge button to make the refrigerator colder in 1°C steps. Once 0°C is reached, the display will return to 7°C with the next button press. The bar graph gets smaller with colder refrigerator settings.

Fast freeze function



Use the fast freeze function when you add a large amount of food to the freezer compartment. This freezes the food quickly but does not affect the temperature in the refrigerator compartment. To use this function, press the fast freeze button once. An animated icon will light up. The fast freeze function will now operate for 90 minutes. If you want to turn the fast freeze function off before 90 minutes have passed, simply press the fast freeze button again. The icon will disappear and the freezer will return to normal operation.

Freezer temperature alarm



If the alarm sounds for no apparent reason, check whether anything is keeping the door open. If the freezer becomes too warm due to the freezer door being left open or warm food being placed too close to the temperature sensor, a buzzer will sound. The icon adjacent to the alarm reset button, the freezer set temperature and bar graph will all flash, until the alarm reset button is pressed. Once pressed, the alarm disable icon adjacent to the alarm button will illuminate for 50 minutes, or until the temperature drops to an acceptable level. Make sure nothing is holding the freezer door open and move any warm food away from the temperature sensor. If the freezer is still too warm after 50 minutes, the alarm will sound again, indicating that something may be wrong with the refrigerator.

NOTE:

The freezer temperature alarm can be reset for 12 hours by pressing the alarm reset button continuously for 10 seconds.

Door alarm

If the fridge door is left open for more than two minutes, the alarm will buzz and an arrow pointing to an open door will flash, along with the temperature setting and bar graph. If you want to leave the door open while you load the refrigerator, you can turn the alarm off for 8 minutes by pressing the alarm reset button.

Child Lock

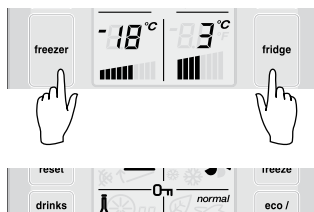

Press and hold the freezer and fridge buttons together to activate the child lock. This will disable the display to prevent accidental changes to settings. To turn the child lock off, press and hold the freezer and fridge

buttons together.

Drinks chill timer



The drinks chill timer is used to quickly chill a bottle. Place the bottle in the freezer and the timer can be set for a minimum of 5 minutes to a maximum of 30 minutes. To set, simply press the drinks chill button repeatedly for the number of minutes (in 5-minute intervals). Once set, an animated icon appears beside the drinks chill button, with a timer that counts down one minute at a time.

You can change the time or turn the timer off even after the countdown has started. A buzzer will tell you when the time is finished and the icon will flash until the alarm reset button is pressed.

If your drink is not cold enough, reset the drinks chill function (remembering the drink is already partially chilled).

Suggested chilling times:

- 10 minutes for cans of drink
- 20 minutes for bottles of wine
- 30 minutes for bottles of soft drink



appliancesonline
.com.au

Australia's largest online appliance retailer

Manual (rotary) controls – Manual models

Energy efficiency

Your refrigerator has been designed to be energy-efficient and can operate in three modes: Normal, Eco and Holiday.

• Normal mode



Normal mode is used when the refrigerator door is often opened. It's the default mode of your refrigerator.

• Eco mode



Eco mode can be used if you don't open your refrigerator door a lot. It is activated in one of two ways:

- by manually pressing the eco/holiday button once when in normal mode, or,
- by automatically activates after 30 hours if the refrigerator door has not been opened.

The leaf icon will appear on the electronic display when eco mode is on. If eco mode is activated automatically, the refrigerator will revert to normal mode once the refrigerator door is opened. If eco mode is entered manually, opening the door will not revert it back to normal mode. To exit eco mode, simply press the eco/holiday button until the word "normal" is displayed. Use Eco mode when you're not using the refrigerator all the time (eg. as a long-term storage refrigerator). If the door is going to be opened a lot, switch back to normal mode. Remember, if eco mode is turned on manually, it won't switch off automatically.

• Holiday mode



Use this button when you go on holiday or leave the house for long periods. The refrigerator minimises defrosting to save energy but maintains your temperature settings. To put the refrigerator into holiday mode, press the eco/holiday mode button until the aeroplane icon appears. The holiday mode will operate until the button is pressed again or the refrigerator door is opened.

NOTE: Opening the freezer door won't effect the operation of either Eco or Holiday modes.

Eco and Holiday Modes minimise defrosting to save energy, while maintaining your temperature settings.

Other special refrigerator features (electronic models only)

- Independent control of the compressor and fan to provide the best performance.
- Extra cooling depending on the number of times the door is opened.
- Automatic defrost when the door is not frequently opened.

NOTE: Display malfunctions may be due to brief power supply interruptions. If this occurs, turn the refrigerator off at the power point and wait 5 minutes. The refrigerator pressure will need time to equalise before you turn the refrigerator on again.

Controlling the temperature

Set the temperature by using the main temperature controls at the rear of the refrigerator compartment. When you first start your refrigerator, set both refrigerator and freezer controls to MID.

i tips and information

A good indication of optimal freezer temperature is ice cream that is frozen, but still soft enough for easy scooping. For the fridge compartment, we recommend using drinking water and simply adjusting the fridge controls until the water is at your ideal temperature.

To change settings. When you change temperature settings, make small adjustments and wait 24 hours before assessing whether you need to make any further changes.

i tips and information

- **Coldest freezer setting is not recommended in normal and very hot climates as this will limit the cooling to the refrigerator section.**
- In very cold climates (where temperatures are below 10°C) the freezer may need to be set colder.
- **Adjusting the freezer temperature – top mount freezer (TM) model**
 1. Select the freezer control (top knob).
 2. Rotate the knob clockwise to set colder.
 3. Rotate the knob anti-clockwise to set less cold.

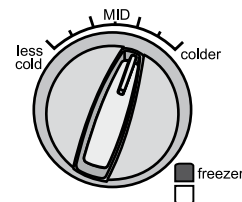

- **Adjusting the refrigerator temperature – top mount freezer (TM) model**

1. Select the refrigerator control (bottom knob).
2. Rotate the knob clockwise to set colder.
3. Rotate the knob anti-clockwise to set less cold.

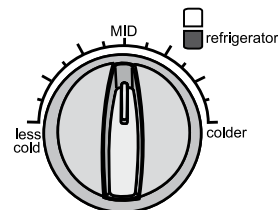

Using your appliance

- **Adjusting the refrigerator temperature – bottom mount freezer (BM) model**

1. Select the refrigerator control (top knob).
2. Rotate the knob clockwise to set colder.
3. Rotate the knob anti-clockwise to set less cold.

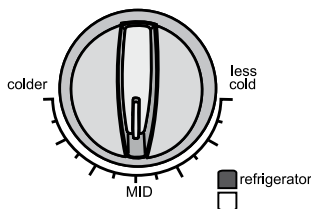

- **Adjusting the freezer temperature – bottom mount freezer (BM) model**

1. Select the freezer control (bottom knob).
2. Rotate the knob clockwise to set colder.
3. Rotate the knob anti-clockwise to set less cold.

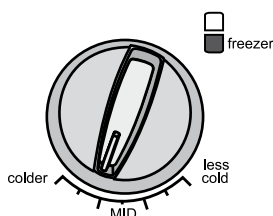

- **Adjusting the all refrigerator temperature – single door all refrigerator (AR) built-in refrigerator models**

1. Rotate the knob clockwise to set colder.
2. Rotate the knob anti-clockwise to set less cold.

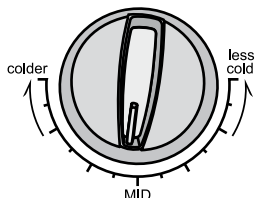

- **Adjusting the all freezer temperature – single door all freezer (AF) and built-in freezer model**

1. Rotate the knob clockwise to set colder.
2. Rotate the knob anti-clockwise to set less cold.

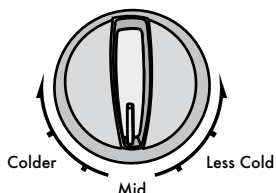

This section tells you how to make the most of the many useful features - cleaning instructions can be found on page 10.

Crisper bin

Use the crisper bin to store vegetables, fruit or smallgoods. Change the humidity by sliding or rotating the humidity control.

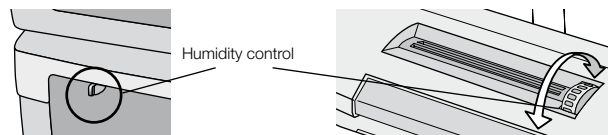

- **Storing vegetables**

Store vegetables in the crisper bin and remember to set the humidity control to more humid (closed).

- **Storing fruit & smallgoods**

Store fruit and smallgoods in the crisper bin and remember to set the humidity control to less humid (open).

- **Removal (standard Crisper Bins)**

1. Empty food from the drawer.
2. Remove the crisper bin(s) by pulling forward, then up and forward again.
3. Remove the crisper shelf by lifting the catches on the underside of the shelf and pulling the shelf forward.

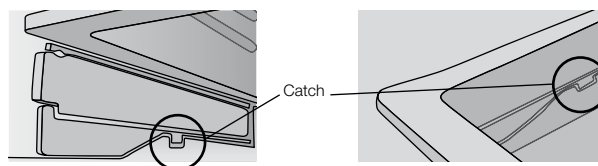

- **Removal (on telescopic extension slides)**

Remove the crisper bin(s) by pulling forward, then up and forward again, lifting the bin off the slides. Push the slides back into the refrigerator.



warning

Never close the door while the telescopic slides are extended. It may damage the slide and/or the refrigerator or cause the slide to become disengaged from the refrigerator.



warning

To clean a crisper cover with telescopic extension slides, simply wipe with a damp cloth and warm soapy water. Never immerse the cover in water, as this could affect the operation of the slide.

- **To refit**

1. With the runners pushed in all the way.
2. Slide the bin into place over the telescopic slides and under the shelf. Push the bin in until it stops, noting that the bin will not be closed all the way.
3. Open the bin to access the finger tabs at the ends on each side of the bin. Use your thumb and forefinger to lift the bin over the ends of the slide and clip in place.
4. Fully close the bin.



caution

Never store solvents or flammable materials like nail polish remover or lighter fluid inside your refrigerator. They will affect the life of the plastic components and may taint stored food.

Door storage bins

The top mount models, bottom mount freezer model and all refrigerator models are fitted with door storage bins. These bins adjust to meet different storage needs. All the door bins are completely removable for cleaning. If you want to remove or adjust a bin, lift it over the support lugs on the inner door panel. To replace, push the bin down over the support lugs to lock it in place.

Dairy compartment

Use the dairy compartment to store foods like butter, margarine and cheeses. The compartment is slightly warmer than the rest of the refrigerator compartment, while the lid provides protection against odours.

Chiller bin (where fitted)

Use the chiller bin to store foods like smallgoods, fresh or cooked meat and cheese, or as an additional crisper. The bin will prevent strong food odours from creeping into the rest of the refrigerator. To remove the chiller bin, pull it forward, then lift it up and pull it further forward.

Modula bottle caddy

The Modula bottle caddy is made of anodised aluminium. They are used to store various types of bottles like wine or beer. Bottles should be stored with the bottom end towards the back of the refrigerator. The fridge arrives with three combined caddies, but they can be separated if desired.

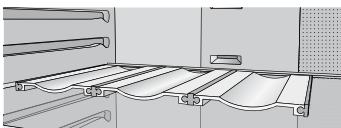

Freezer drawers

Freezer drawers are fitted to bottom mount models and single door all freezer models. The drawers are mounted on telescopic extension slides, to enable full access to the content in the drawer. Clear plastic fronts provide easy visibility of foods.

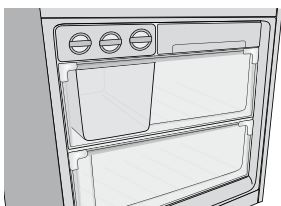

• **To remove the drawer for cleaning,**

1. Empty food from the drawer.
2. Remove the drawer by pulling it forward and lifting the front to unhook it from the slides. Once you have removed the drawer, ensure the slides are pushed back so they are fully closed.

• **To remove the drawer for cleaning,**

1. Empty food from the drawer.
2. Remove the drawer by pulling it forward and lifting the front to unhook it from the slides. Once you have removed the drawer, ensure the slides are pushed back so they are fully closed.



warning

Never close the door while the telescopic slides are extended. This may damage the slide and/or refrigerator or cause the slide to become disengaged from the refrigerator.

• **To replace the drawer**

1. With the telescopic slides pushed in all the way.
2. Slide the drawer into place over the slides and push the bin in until it stops. The bin will not be closed all the way.
3. Open the bin to access the finger tabs at the ends of the telescopic slides, on each side of the bin. Using your thumb and forefinger, lift the bin over the end of the slide and clip in place. If the drawer is not fully engaged on the slide, it's possible the drawer won't stay on the slide if fully extended.

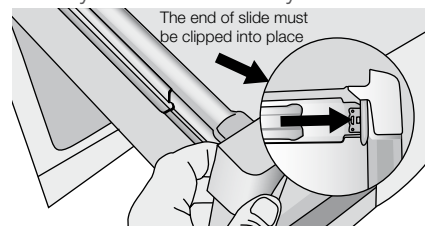

4. Fully close the bin.

When replacing the drawers after cleaning, we recommend fitting the lower drawer first.

Freezer baskets (built-in freezer only)

Freezer baskets and a freezer shelf are fitted to built-in freezers. Wire baskets are used to provide easy visibility of the contents. Both the baskets and the shelf pull out for easy access and have a stop to prevent the basket and shelf being pulled out too far.

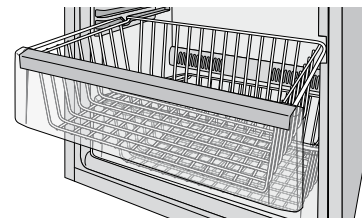

To remove the basket or shelf, pull it out until it hits the stop then lift the front to unhook the stop while continuing to pull forward.

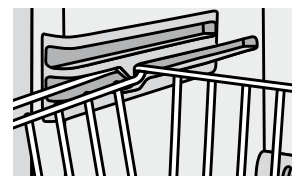

Spillsafe™ glass shelves

Spillsafe™ glass shelves keep spills on the shelf. A shelf retaining system minimises accidental movement of shelves and they can be adjusted to various heights. Spillsafe™ glass shelves are not to be used as slide out shelves. To remove the shelves, gently pull them forward until the shelf comes clear of the shelf guides. To return the shelf, make sure there is nothing behind that may obstruct movement. Gently push the shelf into the cabinet and back into position.

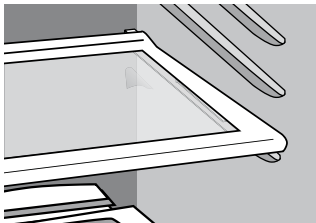

Slide away glass shelf (where fitted)

This shelf can be used either as a full depth shelf or when tall items need to be stored at the front of the appliance it can be collapsed to half its original depth.

- **To collapse the shelf:**

1. Pull the front half of the shelf forward.

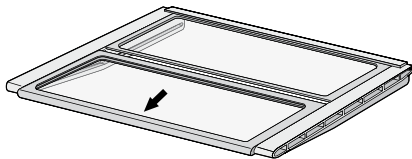

2. Then, from the underside, lift the front half of the shelf by raising the rear edge over the recessed hook detail.

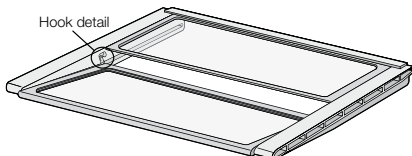

3. Pull the shelf forward and allow the rear to drop into the side channels.

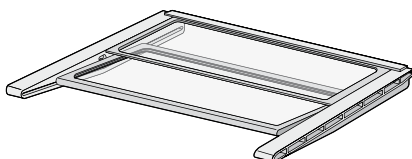

4. Push the front shelf backwards (3,4) until it reaches the rear stops.

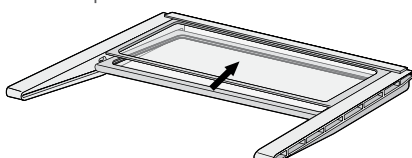

- **Repositioning:**

The shelf can be repositioned within the appliance unit by pulling the whole assembly out until the side panels are free to pivot down, then pivoting the rear of the shelf until the shelf is free from the liner runners. The shelf can then be positioned in any of the runners – this is a very useful feature if your appliance door happens to have limited access.

Deodoriser (where fitted)

Your appliance is fitted with a catalysing deodoriser to assist with the removal of food odours inside your appliance. Odours are removed by adsorption through the filter by the normal operation of the appliance. Keeping food covered and wrapping food with plastic wrap will also help to reduce the odours inside your appliance.

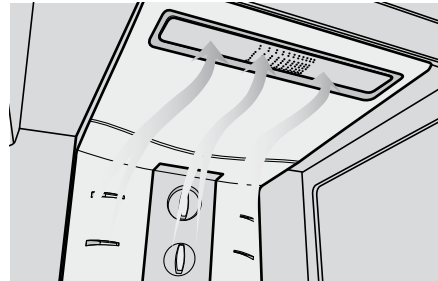

Bottle twist holder operation (where fitted)

The bottle twist holder is used to prevent bottles from falling over. The bottle twist holder consists of two parts, a sliding front, and a rotating retainer ring.

The bottle twist holder can be used in two positions:

- **Horizontal**

When the bottle twist holder ring is horizontal, any item that fits within the ring can simply be placed inside it.

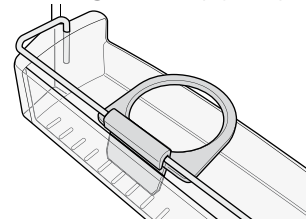

- **Vertical**

When the bottle twist holder ring is vertical, it is possible to simply slide the bottle twist holder along the bottle retainer bar until it is pushed up against a bottle.

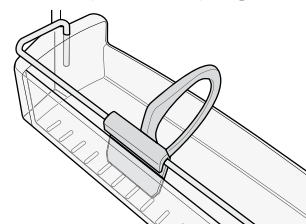

Note:

The bottle should be constrained on the other side by either the end of the bin or other adjacent bottles.

Twist Ice & Serve (where fitted)

Top mount, bottom mount and single door all vertical freezer models have a twist ice & serve ice cube tray assembly. To use, remove the tray, fill with water and place back in the freezer. Once ice has formed (approximately 3 hours) simply twist the knob at the front clockwise until the ice drops into the bin below.

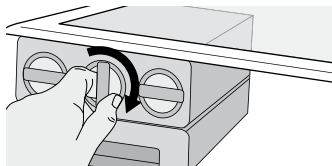

A larger bin is provided in some bottom mount models along with an ice scoop.

Mounting the Twist & serve ice to the other side of the freezer (top mount and built-in freezer models only)

1. Remove the ice bin and ice cube tray. If the ice tray assembly is frozen to the carriage, simply squeeze the tray and shelf together to break the ice.
2. Before you remove the ice carriage, remember to disengage it from the glass shelf (as shown), as it may result in damage to the assembly.

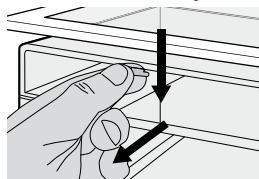

3. Remove the centre runner by disengaging it at the front of the shelf, and removing it from the rear.
4. Refit the runner in to the rear of the shelf on the right hand side and then engage the front (as shown).

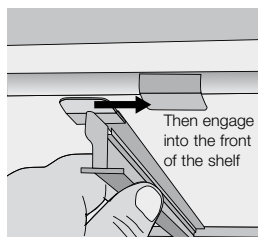
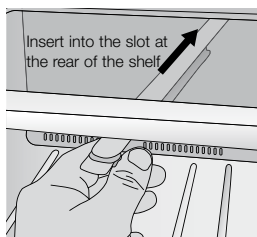

5. Fit the carriage by sliding it into the runners until the front of the carriage engages with the shelf.
6. Refit the ice tray and ice bin.

**warning**

Before changing any light bulb, switch the power off at the power point and remove the power cord from the power point.

Changing the light bulb**Refrigerator light**

1. Switch off the power at the power point and remove the refrigerator's power cord from the power point.
 2. Remove shelves.
 3. Carefully unclip the light cover. You do this by pulling the upper part of the cover towards the front of the cabinet.
 4. Unscrew the light bulb and replace it with a bulb that is the same as the original. If, when you remove the light bulb the small rubber "O" ring comes out with the bulb, fit the "O" ring over the new bulb and screw bulb into the socket (see diagram below).
- Never insert your finger into the light bulb socket to check for the presence of the "O" ring.**
5. Replace the light cover by hooking the light cover lugs into the bottom of the housing and pressing the upper part of the cover until it clips in.
 6. Replace shelves.
 7. Wait 5 minutes to ensure pressures in the refrigeration system are equalized. Then reconnect and turn the refrigerator on at the power point.

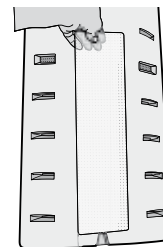
**Freezer light (where fitted)**

1. Switch off the power at the power point and remove the refrigerator's power cord from the power point.
2. Carefully unclip the light cover. You do this by pulling the light cover tab at the rear towards the front of the cabinet.
3. Unscrew the light bulb and replace it with a bulb that is the same as the original. If, when you remove the light bulb the small rubber "O" ring comes out with the bulb, fit the "O" ring over the new bulb and screw bulb into the socket (see diagram below).

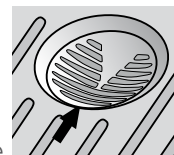

Top freezer model
(electronic models only)

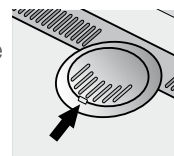

Single door all freezer and
built-in freezer model



Never insert your finger into the light bulb socket to check for the presence of the "O" ring.

4. Replace the light cover by hooking the light cover lugs into the front of the housing and pressing the rear of the cover up until it clips in.
5. Wait 5 minutes to ensure pressures in the refrigeration system are equalized. Then reconnect and turn the refrigerator on at the power point.

i tips and information

Ensure the 'O' ring is in place before replacing the bulb.

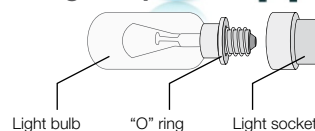

General information

Cleaning the appliance

**warning**

BEFORE CLEANING: Turn appliance off at the power point, then remove power cord from socket. This will make sure there is no chance of getting an electric shock.

- **Doors and exterior – stainless steel**

Your stainless steel appliance is manufactured from a mark resistant stainless steel. This stainless steel has a special advanced protective coating that eases the removal of marks such as finger prints and water spots. To keep your stainless steel appliance looking at its best, you should clean it regularly. You should only clean the stainless steel doors with luke-warm soapy water and a soft cloth, rinsing with clean water and then wipe the surface with clean water and a soft clean cloth to remove soap residue.

It is important to wipe in the direction of the grain of the stainless steel to avoid undue marking of the surface.

- **Doors – surface hardened acrylic**

You should only clean the acrylic doors with lukewarm soapy water and a soft cloth, rinsing with clean water and the wipe the surface with clean water and a soft clean cloth to remove soap residue.

**caution**

Do not use stainless steel cleaners, abrasive pads or other cleaners as they are likely to scratch the surface. Damage to this product after delivery is not covered by your warranty.

- **Interior**

You should clean the appliance interior regularly. It will be easiest to clean when the food supply is low. Wash the interior with a soft cloth and use an unscented mild soap with lukewarm water. Thoroughly dry all surfaces and removable parts. Avoid getting water on appliance controls. If you have taken out any removable parts, replace them and switch the power on before re-stocking the appliance with food. Naturally, you should keep the interior of your appliance hygienic by promptly and thoroughly wiping up any food spills. Don't use a steam cleaner. If live components come into contact with condensing steam, they may short-circuit or cause an electric shock.

- **Door seals**

Take care to keep door seals clean. Sticky food and drink can cause seals to stick to the cabinet and tear when you open the door. Wash seal with a mild detergent and warm water. Rinse thoroughly and dry.

**caution**

Never use hot water, solvents, commercial kitchen cleaners, aerosol cleaners, metal polishes, caustic or abrasive cleaners, or scourers to clean this appliance, as they will damage it. Many commercially available cleaning products and detergents contain solvents that will damage your refrigerator. When cleaning, use only a soft cloth with an unscented mild soap and lukewarm water.

Safety

It is important to use your appliance safely. This means you need to supervise young children and infirm persons when they use it. You need to make sure that young children do not play with the appliance. Follow the tips below.

always do this

- ⓘ **Check the power point is properly grounded - if you are not sure get an electrician to check it.**
- ⓘ **Switch off the appliance at the power point before you clean or move it.**
- ⓘ **If the supply cord is damaged you should have it replaced by the manufacturer, it's service agent or similarly qualified person. This will prevent a safety hazard.**
- ⓘ **This appliance contains insulation formed with flammable blowing gases. For safety reasons, take care when you dispose of it.**

never do this

- ⓧ **Never let children play with the appliance.**
- ⓧ **Never store spray cans, explosive liquids or flammable liquids in the refrigerator.**
- ⓧ **Never store fizzy drinks in the freezer compartment.**
- ⓧ **Never lick icy foods when they first come out of the freezer. This can freeze burn your lips and mouth.**
- ⓧ **Never try to repair the appliance yourself.**
- ⓧ **Do not use mechanical devices or other means to accelerate the defrosting process, other than those recommended by the manufacturer.**
- ⓧ **Do not use electrical appliances inside the food storage compartments of the appliance, unless they are of the type recommended by the manufacturer.**
- ⓧ **Do not damage the refrigerant circuit.**

**warning**

When disposing of your old refrigerator or freezer, remove all doors. Children can suffocate if they get trapped inside.

Switching off your appliance

If the appliance needs to be switched off for an extended period, the following steps should be taken to reduce the symptoms of mould:

1. Remove all food.
2. Remove the power plug from the power point.
3. Clean and dry the interior thoroughly.
4. Ensure that all the doors are wedged open slightly for air circulation.

**caution**

Automatic aerosol systems (such as insect control) should not be located adjacent to the product as the spray may cause long term damage to the external plastics of the appliance.

Troubleshooting

If you think something may be wrong with your refrigerator, you can carry out some easy checks before calling for service. You may locate the problem, sparing yourself from inconvenience, saving time and money.

problem	solution
Refrigerator is not operating	<ul style="list-style-type: none"> • Check that the power cord is plugged into the power outlet properly and that the outlet is switched 'ON'. • Try running another appliance from the power outlet. If no power is coming from the outlet you may have blown a fuse or tripped a circuit of your household power supply. • Try adjusting the temperature control to a slightly "colder" position. • It is normal for the freezer fan NOT to operate during the automatic defrost cycle, or for a short time after the appliance is switched on.
When there is refrigerator/freezer noise	<p>Modern refrigerators/freezers with increased storage capacity use high speed compressors. These can provide a seemingly high level of sound which is quite normal. Normal operational sounds include:</p> <ul style="list-style-type: none"> • Occasional gurgling, similar to water boiling. • Air flow noise (air circulates because of a small fan). • A popping noise heard during automatic defrost. • A clicking noise heard just before the compressor starts (this is just the automatic switching action of the temperature control, turning the compressor on or off). <p>Other strange sounds may mean that you need to check and take action. For example, noises may mean that:</p> <ul style="list-style-type: none"> • The cabinet is not level. • The floor is uneven or weak. • Bottles are badly placed and rattling. • There are vibrations from an object on top of or behind or beside the refrigerator. • The back of the refrigerator cabinet is touching the wall. <p>Remember it is quite normal for noise to seem louder just after the refrigerator starts operating.</p>
If there are odours inside the refrigerator	<ul style="list-style-type: none"> • The interior may need cleaning. • Some foods produce odours. • Some containers and wrapping can cause odours. • Ask yourself if the odour started about the same time you started storing something unusual.
If the electronic controls do not respond.	If no buttons have been pressed for approx. 60 seconds there may be a delay of up to 2 seconds before the display reacts. This is to prevent accidental changes to settings.

problem	solution
When the motor seems to run more than expected	<p>Your new refrigerator has a large fridge and freezer section to keep cool. So it is normal to frequently hear the sound of the motor. However, to keep operation to a minimum check the following:</p> <ul style="list-style-type: none"> • Are doors kept open too long or too often? • Are controls set too cold? See 'Controlling the temperature' on pages 4 – 6. • Have large amounts of warm food just recently been stored? Summer, festive seasons and holidays usually mean a lot more work for your refrigerator. • If the day is hot or the room is very warm, the refrigerator will need to run more than normal. • The refrigerator will run more than normal just after you install it or when it has been turned off for a long time.
If the temperature in the refrigerator is too warm	<ul style="list-style-type: none"> • Check that the appliance has enough clearance at the sides, back and top. Refer to the installation instructions on page 2. • Refer to 'Controlling the temperature' on pages 4 – 6. • You may have kept the door open too long or too frequently. • Food containers or packaging may be holding a door open.
If the temperature in the refrigerator is too cold	<ul style="list-style-type: none"> • Refer to 'Controlling the temperature' on pages 4 – 6. • Increase the temperature to avoid high energy consumption.
If heavy frosting occurs in the freezer	Make sure you fully close the freezer and fridge doors. If the doors are left open, a heavy frost will coat the inside of the freezer. If a frost develops, remove it and take care to properly close the doors.
If water drips on the floor	The defrost water tray, (located at the back or underneath of the cabinet) may not be properly positioned, or the drain tube may not be properly positioned to direct water into this tray. You may need to pull the refrigerator away from the wall to check the tray and tube.
Fridge does not exit vacation mode	Turn appliance off at the power point. Leave off for three (3) minutes for the memory to clear, then turn back on.
If the doors will not close	<ul style="list-style-type: none"> • Check whether the top of the refrigerator is tilted back 10-15mm to allow the doors to self close. • Check whether something is holding the door open. <p>It is normal for the freezer door to momentarily open and re-close, when the food storage compartment door is closed. If the freezer door stays open, it indicates that the refrigerator needs to be tilted backwards a little further. If you call a service person to solve this problem you will be charged for the cost of the service call, this is not a warranty fault.</p>

If you still require service

If you have a problem, and the problem persists after you have made the checks mentioned above, contact your nearest Electrolux approved Service Provider or the dealer you bought the refrigerator from. Be ready to quote the model number, 9-digit PNC and 8-digit serial number, which is stated on the label inside the refrigerator compartment.

Electrolux Warranty

FOR SALES IN AUSTRALIA AND NEW ZEALAND
 APPLIANCE: ELECTROLUX TOP MOUNT FREEZER, BOTTOM MOUNT FREEZER,
 SINGLE DOOR ALL REFRIGERATOR, SINGLE DOOR ALL FREEZER, BUILT-IN
 REFRIGERATOR, BUILT-IN FREEZER

This document sets out the terms and conditions of product warranties for Electrolux branded appliances. It is an important document. Please keep it with your proof of purchase documents in a safe place for future reference should you require service for your Electrolux appliance.

General Terms and Conditions

1. In this warranty
 - (a) 'Electrolux' means Electrolux Home Products Pty Ltd ABN 51 004 762 341 in respect of Appliances purchased in Australia and Electrolux (NZ) Limited in respect of Appliances purchased in New Zealand;
 - (b) 'Appliance' means any Electrolux product purchased by you accompanied by this document;
 - (c) 'Warranty Period' means
 - (i) where you use the Appliance for personal, domestic or household purposes in Australia the period of '24' months and in New Zealand the period of '24' months;
 - (ii) where you use the Appliance for commercial purposes, in Australia the period of '3' months and in New Zealand the period of '3' months, (if the period stated is 0 months you are not covered by this product warranty) following the date of original purchase of the Appliance;
 - (d) 'you' means the purchaser of the Appliance not having purchased the appliance for re-sale, and 'your' has a corresponding meaning.
2. This warranty only applies to Appliances purchased and used in Australia or New Zealand and is in addition to (and does not exclude, restrict, or modify in any way) any non-excludable statutory warranties in Australia or New Zealand.
3. Electrolux warrants that, when dispatched from an Electrolux warehouse, the Appliance is free from defects in materials and workmanship for the Warranty Period.
4. During the Warranty Period Electrolux or its Authorised Service Centre will, at no extra charge if your appliance is readily accessible without special equipment, and subject to these terms and conditions, repair or replace any parts which it considers to be defective. You agree that any replaced Appliances or parts become the property of Electrolux. This warranty does not apply to light globes, batteries, filters or similar perishable parts.
5. Parts and Appliances not supplied by Electrolux are not covered by this warranty.
6. Where you are within an Electrolux service area, this warranty covers the cost of transport of the Appliance to and from Authorised Service Centres of Electrolux and travelling costs for representatives of the Authorised Service Centre to and from your home or business. If you are outside an Electrolux service area, you will bear these costs. For information about whether you are within an Electrolux service area, please phone 13 13 49 in Australia, or 0800 10 66 10 in New Zealand.
7. Proof of purchase is required before you can make a claim under this warranty.
8. You may not make a claim under this warranty unless the defect claimed is due to faulty or defective parts or workmanship. Electrolux is not liable in the following situations (which are not exhaustive):
 - (a) The Appliance is damaged by:
 - (i) accident
 - (ii) misuse or abuse, including failure to properly maintain or service
 - (iii) normal wear and tear
 - (iv) power surges, electrical storm damage or incorrect power supply
 - (v) incomplete or improper installation
 - (vi) incorrect, improper or inappropriate operation
 - (vii) insect or vermin infestation.
 - (b) The Appliance is modified without authority from Electrolux in writing.
 - (c) The Appliance's serial number or warranty seal has been removed or defaced.
 - (d) The Appliance was serviced or repaired by anyone other than Electrolux or its Authorised Service Centres.
9. This warranty, the contract to which it relates and the relationship between you and Electrolux are governed by the law applicable in the Australian State where the Appliance was purchased or the law applicable in New Zealand if the Appliance

was purchased in New Zealand. Where the Appliance was purchased in New Zealand for business purposes the Consumer Guarantee Act does not apply.

Limitation of Liability

10. To the extent permitted by law:
 - (a) Electrolux excludes all warranties other than as contained in this document;
 - (b) Electrolux shall not be liable for any loss or damage whether direct or indirect or consequential arising from your purchase, use or non-use of the Appliance.
11. Provisions of the Trade Practices Act and State consumer legislation in Australia, and the Consumer Guarantees Act, the Sale of Goods Act and the Fair Trading Act in New Zealand, imply warranties or conditions, or impose obligations, upon Electrolux which cannot be excluded, restricted or modified. To the extent permitted by law, the liability of Electrolux (if any) arising out of or in relation to the Appliance or any services supplied by Electrolux shall be limited (where it is fair and reasonable to do so):
 - (a) in the case of Appliances, at its option, to the replacement or repair of the Appliances or the supply of equivalent products or the payment of the cost of replacing the Appliances or having the Appliances repaired or of acquiring equivalent Appliances. Upon being replaced, parts and Appliances become the property of Electrolux; or
 - (b) in the case of services, at its option, to the supply of the services again or the payment of the cost of having the services re-supplied; and in the case of Appliances or services supplied in New Zealand, loss or damage whether direct or indirect or consequential that is reasonably foreseeable.

Privacy

You acknowledge that in the event that you make a warranty claim it will be necessary for Electrolux and its Authorised Service Centres to exchange information in relation to you to enable Electrolux to meet its obligations under this warranty.

EXTENDED WARRANTIES AND INDEMNITY

Sealed Refrigeration System Warranty

For a further period of three years following the expiry of the Warranty period, Electrolux or its agent will supply replacements for, or at the sole option of Electrolux, repair, all parts it finds defective in the Sealed Refrigeration System which comprises: compressor, condenser, evaporator, dryer and tubing. During this three year period you will pay for the costs of labour (including any call out or service fees), and freight if necessary in replacing defective parts in the Sealed Refrigeration System. You will pay for the costs of transport of the Appliance if further service is required and the costs of parts or repairs to parts other than those included in the Sealed Refrigeration System

Frozen Food indemnity

Subject to the following exclusions, Electrolux will indemnify you for a period of 24 months from the date of purchase of the Appliance against any loss or damage to frozen foodstuffs due to a Sealed Refrigeration System breakdown. This indemnity will be limited to:

- (a) in the case of freezers with a capacity of less than 400 litres – AU\$150
 - (b) in the case of freezers with a capacity of 400 litres or more – AU\$300
- This indemnity does not cover loss or damage to frozen foodstuffs occasioned by:
- (a) failure to plug in the freezer to a properly connected power supply or failure to switch on the power point
 - (b) accidental removal of the plug from the power point or switching off the power supply;
 - (c) failure to keep the door or lid of the freezer closed
 - (d) the introduction of abnormal heat loads to the freezer;
 - (e) failure to observe the operating and installation instructions supplied with the freezer; and
 - (f) failure to defrost the freezer at recommended intervals on chest freezers or non frost free models.

Important Notice

Before Calling a Service Technician please check carefully the operating instructions, service booklet and the warranty terms and conditions.

<p>FOR SERVICE or to find the address of your nearest state service centre in Australia PLEASE CALL 13 13 49 For the cost of a local call (Australia only)</p>	<p>SERVICE AUSTRALIA  ELECTROLUX HOME PRODUCTS www.electrolux.com.au</p>	<p>FOR SPARE PARTS or to find the address of your nearest state spare parts centre in Australia PLEASE CALL 13 13 50 For the cost of a local call (Australia only)</p>
<p>FOR SERVICE or to find the address of your nearest authorised service centre in New Zealand FREE CALL 0800 10 66 10 (New Zealand only)</p>	<p>SERVICE NEW ZEALAND  ELECTROLUX HOME PRODUCTS www.electrolux.co.nz</p>	<p>FOR SPARE PARTS or to find the address of your nearest state spare parts centre in New Zealand FREE CALL 0800 10 66 20 (New Zealand only)</p>



Electrolux Home Products Australia

telephone: 1300 363 640

fax: 1800 350 067

email: customercare@electrolux.com.au

web: www.electrolux.com.au

The Thoughtful Design Innovator.

Do you remember the last time you opened a gift that made you say "Oh! How did you know? That's exactly what I wanted!" That's the kind of feeling that the designers at Electrolux seek to evoke in everyone who chooses or uses one of our products. We devote time, knowledge, and a great deal of thought to anticipating and creating the kind of appliances that our customers really need and want.

This kind of thoughtful care means innovating with insight. Not design for design's sake, but design for the user's sake. For us, thoughtful design means making appliances easier to use and tasks more enjoyable to perform, freeing our customers to experience that ultimate 21st century luxury, ease of mind. Our aim is to make this ease of mind more available to more people in more parts of their everyday lives, all over the world. So when we say we're thinking of you, you know we mean just that.

Electrolux. Thinking of you.

Share more of our thinking at www.electrolux.com.au