

Thinking of you

 **Electrolux**



user manual
**side by side
refrigeration**



Congratulations

Congratulations and thank you for choosing our refrigerator. We are sure you will find your new appliance a pleasure to use. Before you use the appliance, we recommend that you read through the entire user manual, which provides the description of the appliance and its functions.

To avoid the risks that are always present when you use an electric appliance, it is important that the appliance is installed correctly and that you read the safety instructions carefully to avoid misuse and hazards.

We recommend that you keep this instruction booklet for future reference and pass it on to any future owners. After unpacking the appliance please check it is not damaged. If in doubt, do not use the appliance but contact your local Electrolux Customer Care Centre.

Contents

| | |
|-------------------------------------|-----------|
| • General installation | 2 |
| • Initial start-up | 4 |
| • Electronic display panel | 5 |
| • Setting the clock | 5 |
| • Features of your appliance | 8 |
| • Changing the water filter | 13 |
| • Cleaning your refrigerator | 14 |
| • Energy consumption | 15 |
| • Safety | 16 |
| • Helpful hints | 16 |
| • Troubleshooting | 17 |
| • Notes | 19 |
| • Warranty | 20 |



before you call

Please ensure you read the instruction manual fully before you call for service, or a full service fee could be applicable.



environmental tip

Information on disposal for users

- Most of the packing materials are recyclable. Please dispose of those materials through your local recycling depot or by placing them in appropriate collection containers.
- If you wish to discard this product, please contact your local authorities and ask for the correct method of disposal.

Compact side by side with standard features

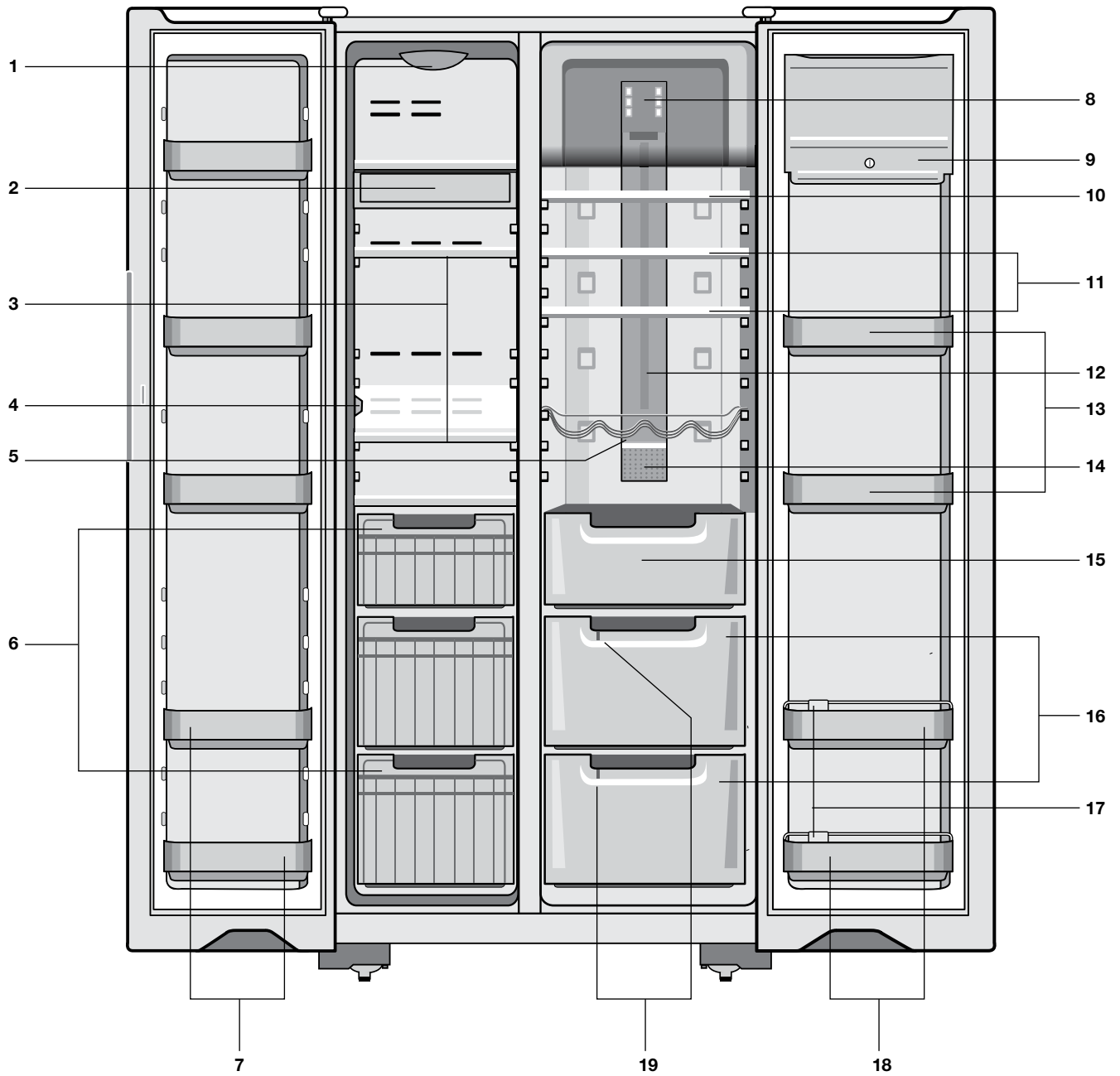

- | | |
|--------------------------------------|---------------------------------------|
| 1 Freezer lighting | 11 Spill-safe slide-out glass shelves |
| 2 Ice cube trays & storage drawer | 12 Fridge lighting |
| 3 Slideout glass shelves | 13 Adjustable door bins |
| 4 Freezer temperature sensor | 14 Sensor & deodoriser |
| 5 Wine Rack | 15 Deli compartment |
| 6 Freezer baskets with clear fascia | 16 Crisper bins |
| 7 Adjustable door bins | 17 Bottle twist holder |
| 8 Electronic temperature controls | 18 Bottle bins |
| 9 Locker compartment | 19 Crisper humidity controls |
| 10 Spill-safe slide-away glass shelf | |

Features may vary depending on model. Not all models will have features listed.

Large side by side with ice and water features

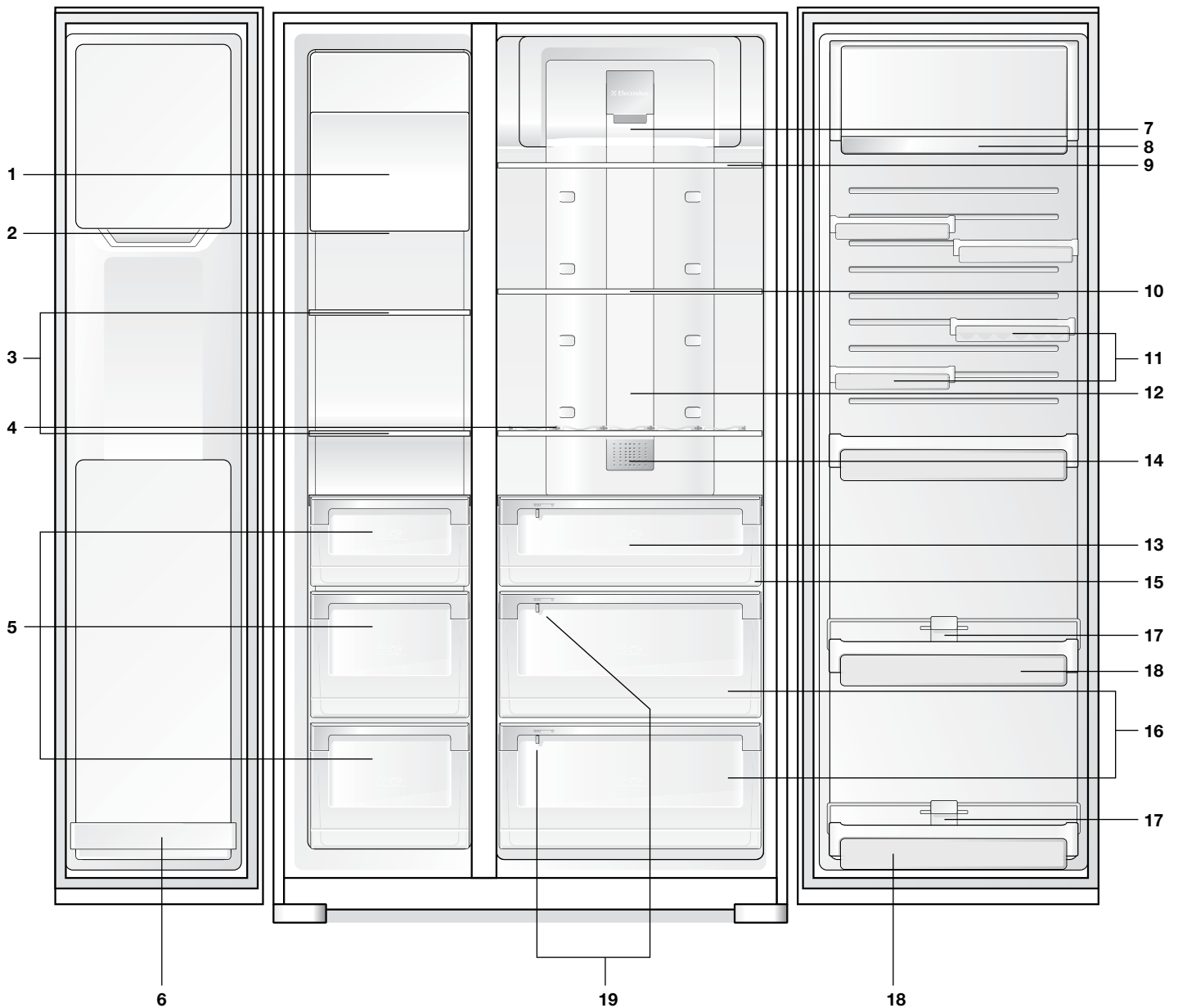

- | | |
|---|--|
| <ul style="list-style-type: none"> 1 Ice maker unit 2 Freezer lighting 3 Slideout glass shelves 4 Modular wine caddy 5 Roll out baskets 6 Adjustable door bins 7 Feature light 8 Locker compartment 9 Spill-safe slide-away glass shelf 10 Spill-safe slide-out glass shelves | <ul style="list-style-type: none"> 11 Adjustable door bins 12 Fridge lighting 13 Deli compartment 14 Sensor and deodoriser 15 Water filter 16 Crisper bins 17 Bottle twist holder 18 Bottle bins 19 Humidity controls |
|---|--|

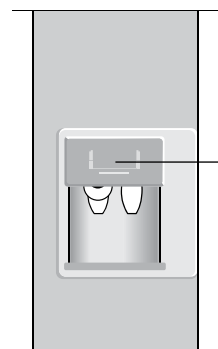

Electronic temperature controls + ice and water controls on freezer door

Features may vary depending on model. Not all models will have features listed.

General Warnings

Please read the user manual carefully and store in a handy place for later reference. Pass the user manual on to possible new owners of the refrigerator.

The symbols you will see in this booklet have these meanings:



warning

This symbol indicates information concerning your personal safety



caution

This symbol indicates information on how to avoid damaging the refrigerator



tips and information

This symbol indicates tips and information about use of the refrigerator



environmental tip

This symbol indicates tips and information about economical and ecological use of the refrigerator



warning

- If pressurised aerosol containers bear the word 'flammable' and/or a small flame symbol, do not store them inside any refrigerator or freezer. If you do so you may cause an explosion.
- When you dispose of your old refrigerators and freezers, remove any doors. Children can suffocate if they get trapped inside.
- This appliance contains insulation formed with flammable blowing gases. Avoid safety hazards by carefully disposing of this appliance.
- This appliance is not intended for use by persons (including children) with reduced physical, sensory or mental capabilities, or lack of experience and knowledge, unless they have been given supervision or instruction concerning use of the appliance by a person responsible for their safety. Children should be supervised to ensure that they do not play with the appliance.
- Don't use a steam cleaner. If live components come into contact with condensing steam, they may short-circuit or cause an electric shock.
- Do not use mechanical devices or other means to accelerate the defrosting process other than those recommended by the manufacturer.



Read the following carefully to avoid damage or injury.



This symbol indicates never to do this



This symbol indicates always do this

It is important to use your refrigerator safely. Check these safety points before using your refrigerator.

- ✓ The appliance must be plugged into its own dedicated 220-240V, 50Hz AC electrical outlet.
- ✓ Ensure that the electric outlet is properly earthed to ground. Consult a qualified electrician if you are unsure.
- ✓ If the power cord is damaged, it should be replaced by a service technician or a qualified person.
- ✓ Check the power cord can reach the power point. Don't plug your refrigerator into an extension cord or double adaptor.
- ✓ Unplug the appliance before cleaning and before changing the light bulb to avoid electric shock.
- ✓ Choose a location that is not too cold – the ambient temperature should be above 10°C.
- ✓ Put the refrigerator in a dry place avoiding areas of high moisture or humidity.
- ✓ In order to avoid a fire, the appliance must be kept clean.
- ✓ Keep ventilation openings, in the appliance enclosure or in the built-in structure, clear of obstruction.
- ✓ Young children should be supervised to ensure they do not play with this appliance.
- ⊘ Never unplug the appliance by pulling on the power cord. Always grip the plug firmly, and pull straight out of the receptacle to prevent damaging the power cord.
- ⊘ Don't plug your refrigerator into a timer fitted to the power point.
- ⊘ This appliance is not suitable for use by young children or infirm persons, without supervision.
- ⊘ Do not put the refrigerator in frosty or unprotected areas, for example in a garage or on a veranda.
- ⊘ Do not put the refrigerator in direct sunlight, near stoves, fires or heaters.
- ⊘ Do not put the refrigerator on an uneven surface.
- ⊘ Do not store flammable materials on or under the appliance, eg. aerosols.
- ⊘ Never let children play with the refrigerator.
- ⊘ Never store fizzy drinks in the freezer compartment.
- ⊘ Never try to repair the refrigerator yourself.
- ⊘ Never use electric heaters or dryers to defrost the freezer because you can receive an electric shock.
- ⊘ Never use electrical appliances inside the refrigerator or freezer.

R600a refrigerant warning

This appliance contains a small quantity of environmentally friendly, but flammable, non-synthetic R600a refrigerant:

- Ensure that the tubing of the refrigerant circuit is not damaged during transportation and installation.
- Leaking refrigerant may cause eye injuries or ignite.
- The room for installing appliance must be at least 1m³ per 8g of refrigerant. The amount of refrigerant in the appliance can be found on the rating plate inside the appliance.

Note: You must read these warnings carefully before installing or using the refrigerator. If you need assistance contact our Customer Care Department. The manufacturer will not accept liability, should these instructions or any other safety instructions incorporated in this book be ignored.

General Installation

When correctly installed, your refrigerator should:

- have adequate clearance to the back, sides and top for air circulation.
- be aligned to the surrounding cupboards
- have doors that will self close from a partially open position

ESE6077S and ESE6107S

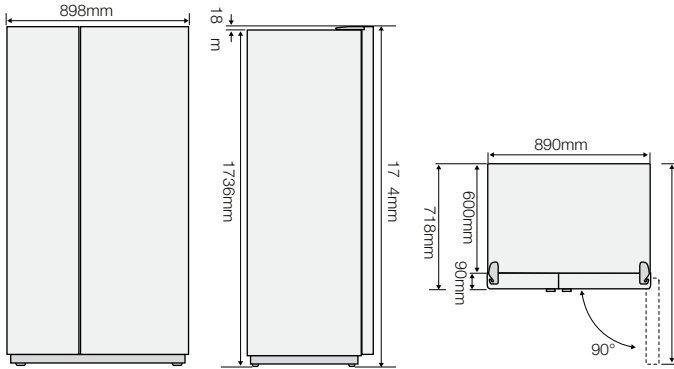

ESE6977S and ESE7007S

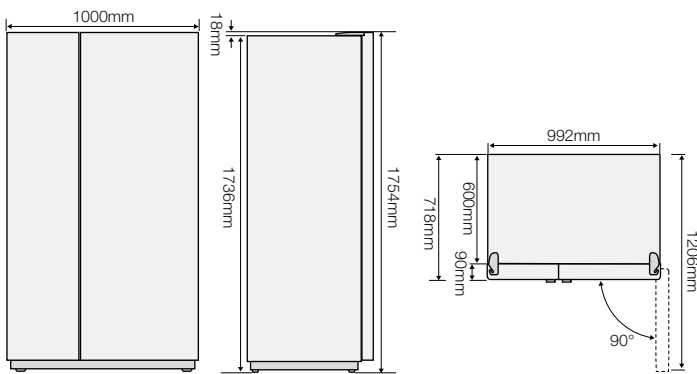

! caution

Automatic aerosol systems (such as insect control) should not be located adjacent to the product as the spray may cause long term damage to the external plastics of the appliance.

Clearances around your refrigerator

Your Side by Side Refrigerator can be installed between cupboards or fixtures but you must allow for the following spaces around the cabinet.

- allow a **minimum** of 5 millimetres clearance on both sides (refer to diagram 1).
- allow a **minimum** of 10 millimetres clearance above hinge covers (refer to diagram 1).
- allow a **minimum** of 50 millimetres at the back of the refrigerator (refer to diagram 1).

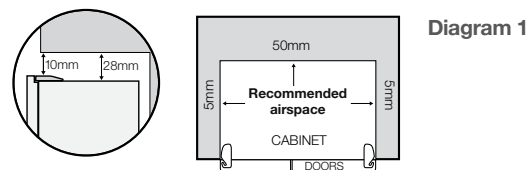

- allow a 200 or 350 millimetres clearance on the hinge side of the doors, if you place the refrigerator next to the wall. This will make cleaning easier (refer to diagram 2).

- make sure that cupboards or fixtures do not stick out further than the refrigerator cabinet.

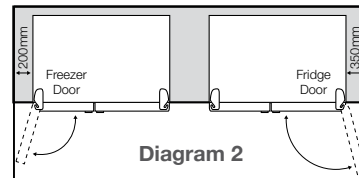

Note: Doors are designed to sit proud of cabinetry (not flush). The clearances shown above are the recommended minimum clearances.

Installation

The refrigerator should arrive with the front rollers wound down. We recommend that the refrigerator be tilted backwards by about 10 to 15 millimetres, this will allow the doors to self close providing a consistent door seal. To do this follow the instructions below.

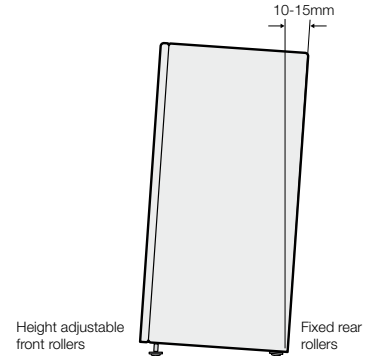

When you want to install your refrigerator, take the following steps.

1. Roll the refrigerator into it's final position.

! warning

The rollers are designed for forward or backward movement only. They are not castors. Moving the refrigerator sideways may damage your floor and the rollers.

2. If the refrigerator is not tilted back you can adjust the two front rollers by adjusting the large plastic roller nut (refer page 3). You may need two people, one to adjust rollers and one to tilt the refrigerator slightly back to take the weight of the appliance off the front rollers. This will increase or decrease the height of the rollers. One turn of the nut will change the tilt of the refrigerator by approximately 10mm.
3. If the cabinet is level, then the side walls should be plumb or vertical. If the cabinet is built in or partly built in check the alignment of the cabinet side against the cupboard.

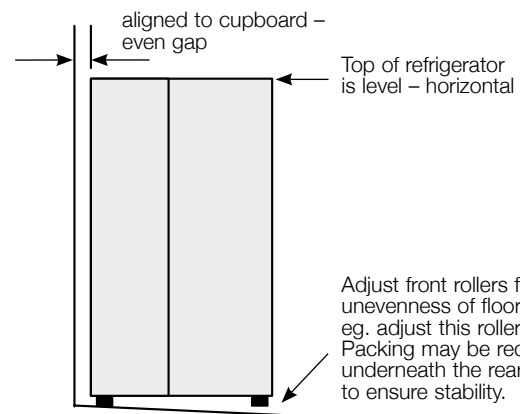

4. If the appliance now rocks from one corner to the opposite rear corner, this means that the floor is uneven, you will need to put some packing under one of the rear rollers.

5. You may now need to fine-tune the installation by adjusting the front rollers once again.

Adjusting door alignment

Each door is independently adjustable in the vertical direction by turning the adjustable bolts under the hinges using the spanner provided.

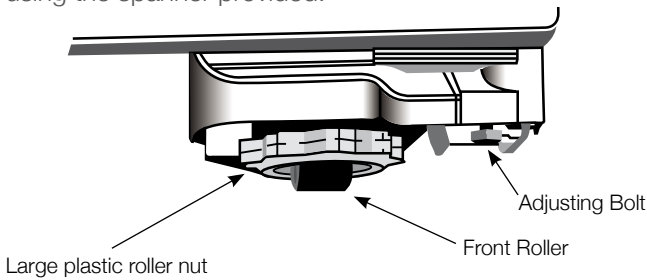

The doors can be adjusted up or down. Depending on the amount of adjustment required it may be sufficient to adjust only one door. (see Diagrams below)

Note: When the height of the rollers and adjusting bolts are correctly adjusted the refrigerator will stand firmly on the floor and the doors will be in line with one another.

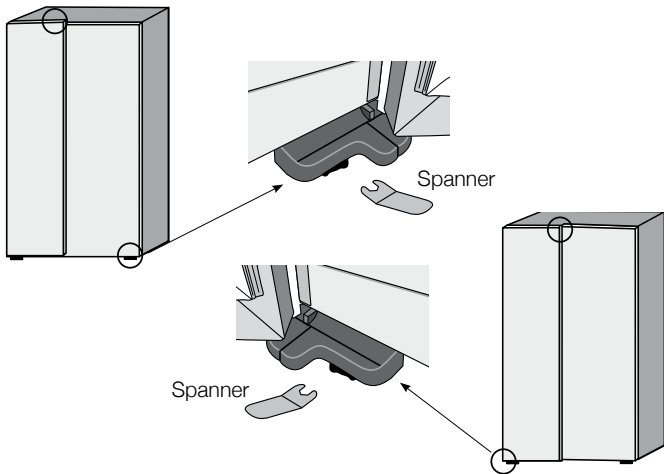

Internal packaging

Please remove any internal packaging material before use. There may be a strip of foam taped to the door bins. There will also be tape applied to several parts such as the locker. There may be a sheet of protective film attached to the multi-flow duct at the rear of the refrigerator section, please remove this prior to operation as it may obstruct airflow. Protective film may also be on the display fitted to the control housing. Please remove all internal packaging before use. Any glue or tape residue or the like should be removed with a solution of mild detergent and water.

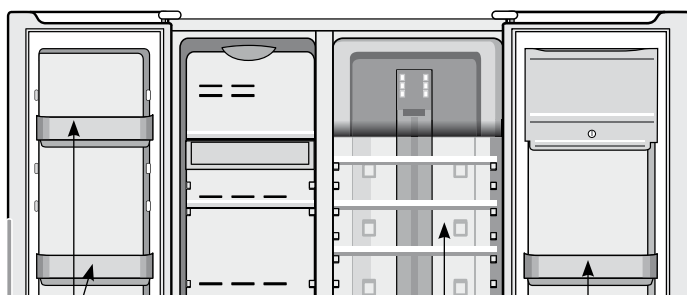

Door bins

Multi-flow duct

Door bins

model ESE6107S shown

Ice and water models

The water connection to your ice and water product should only be done by a licensed refrigeration mechanic, plumber or electrician. All relevant information regarding the water connection is detailed in the water kit provided with your product for use by the professional installer only.

The automatic ice and water dispenser needs a drinkable water supply with a pressure of:

- minimum 206 kPa (30 psi, 2.11 kgf/cm²)
- maximum 689 kPa (100 psi, 7.04 kgf/cm²)

In some areas water pressure is significantly higher due to local conditions. In such areas a pressure reducing valve must be used. Ensure your plumber or installer checks your local water pressure when installing your refrigerator.

If you are using your refrigerator for the first time, or if you have not used the dispenser for some time:

- discard the first seven or eight cups of water
- discard any ice that the ice maker produces in the first 24 hours (contaminants could have settled in the water pipes)

(see page 12 for more information)

The water tap can be anywhere and there is no limit to the amount of pipe between the tap and the refrigerator, however some points to note are:

1. It is better to have the tap accessible without having to roll the refrigerator forward, so we recommend putting it outside the cavity as shown by the taps in the diagram below.
2. It is recommended, but not essential that the height of the tap should be 400mm from the ground.
3. If the refrigerator is required to be pulled forward for cleaning, the water pipe may need to be removed from the tap.

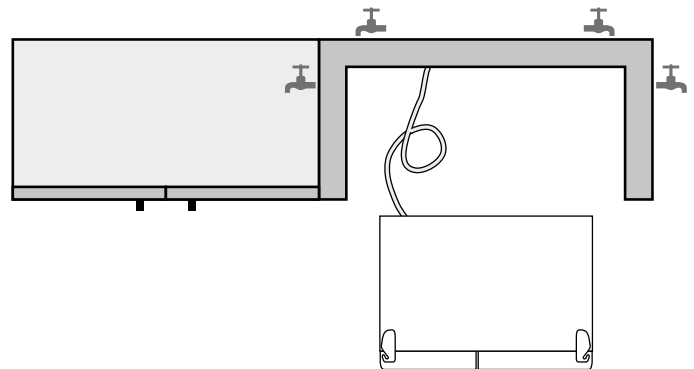

Initial start-up

Ice maker start-up



caution

The water connection to your ice and water product should only be done by a licensed refrigeration mechanic, plumber or electrician.

If the ice maker is not connected to a water supply, check that the ice maker is turned off. To do this remove the ice cream shelf and put the switch in the 'OFF' position. If you don't do this a loud buzzing noise will be heard intermittently if the icemaker is on but no water is being supplied.

If the ice maker is connected to a water supply, check that the ice maker is turned on. To do this put the switch in the 'ON' position.

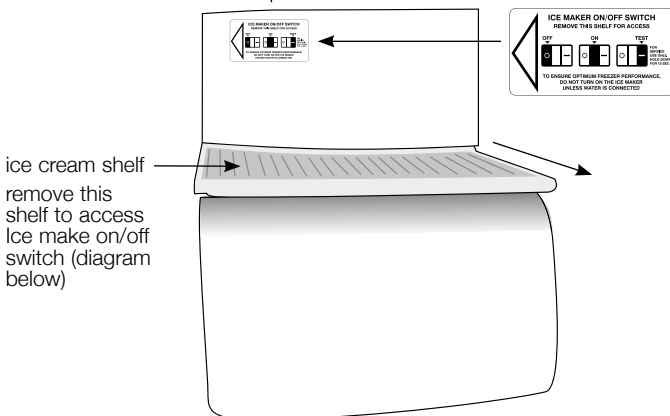
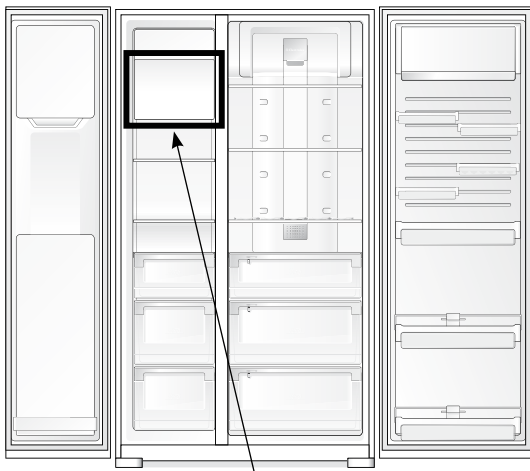

ice cream shelf
remove this
shelf to access
Ice make on/off
switch (diagram
below)

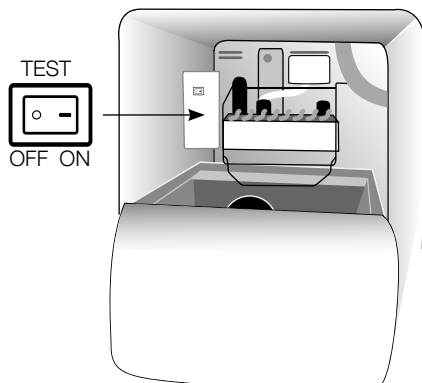

Refrigerator/freezer operation

It is normal for the rear, sides and centre mullion of the refrigerator to feel warm.

These areas are warm because the refrigerator transfers heat from food placed inside the refrigerator to the outside air. There is a cooling coil located behind the rear wall of the freezer section. This coil cools and removes moisture from the air. A fan at the rear of the freezer section then circulates cold, dry air throughout the refrigerator.

This forced air circulation means that foods are refrigerated far more quickly than in refrigerators where there is less air circulation. Avoid placing food against air outlets as this will affect air circulation.

A light frosting will occasionally appear on the interior of the freezer if the freezer door is opened frequently. This is normal and will disappear after a few days in most climates. Make sure you fully close the freezer and fresh food doors after you load or remove food from these compartments. If the doors are left partly open, a heavy frost will coat the inside of the freezer. If a frost develops, remove it. Take care to properly close the doors and the frost will not reoccur.

i tips and information

Your new energy efficient refrigerator uses a variable speed compressor and other efficient components that may produce different noises to your old refrigerator. These sounds are normal and include:

- compressor running noise
- air movement noise from the small fan motor
- occasional gurgling, similar to water boiling
- a popping noise, heard during automatic defrosting
- a clicking noise, just prior to the compressor starting up
- a motorised air baffle used to adjust airflow

These noises are normal and are no cause for alarm. (further details can be found on page 18)

Electronic display panel

tips and information

Temperature sensors

Avoid loading food against your freezer temperature sensor. Doing so may adversely affect freezer temperatures. If warm food is inadvertently loaded against the sensor, it may also set off the freezer temperature alarm up to 50 minutes after the food is loaded against the sensor (see Diagrams below).

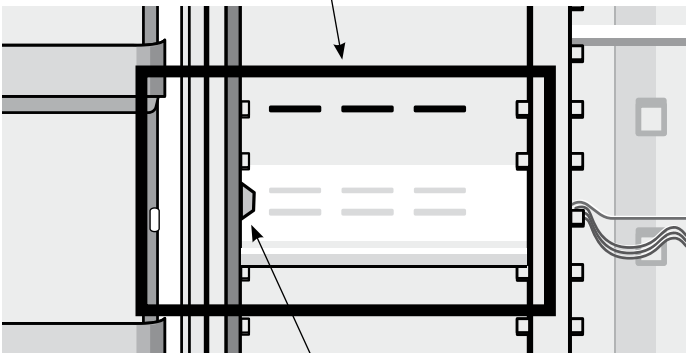
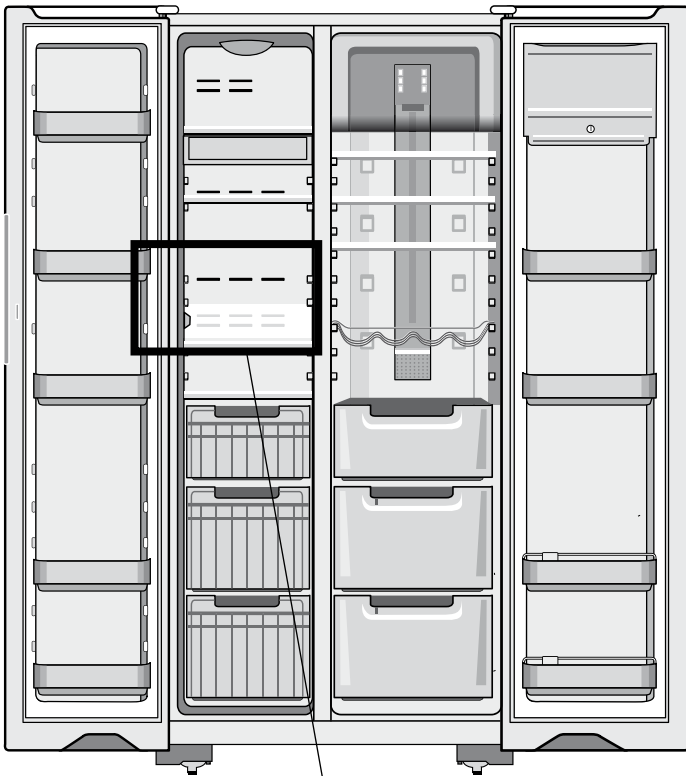

freezer temperature sensor
model ESE6017S shown

Note: Product illustrations demonstrate features that may not be completely in line with all current products.

Ice and water models

Electronic display panel

The electronic display panel consists of an LCD display with white backlighting and 6 push buttons. When the power is first turned on, you will see the default settings, with the white backlighting. If no buttons have been pressed and the fridge door is closed the backlighting will turn off after 30 seconds.

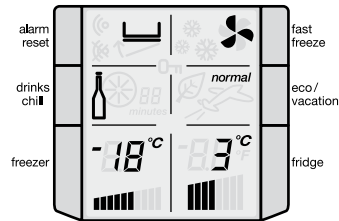
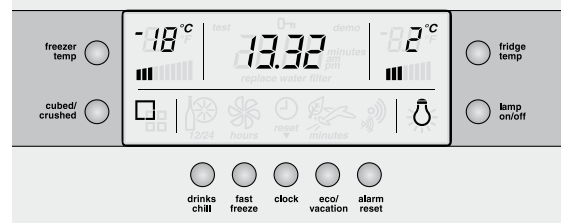

Note: The Electronic Display Panel varies according to the model of refrigerator purchased. The above and following diagrams are only representative of the different types of panels available. Not all models will have all features listed.

NOTE: If no buttons have been pressed for approximately 60 seconds, there may be a delay of up to 2 seconds before the display reacts. This is normal and is to prevent accidental changes to settings.

Setting the clock – ice and water models only

1. Press and hold the clock button down for two seconds. Hours and minutes will then appear on the display.

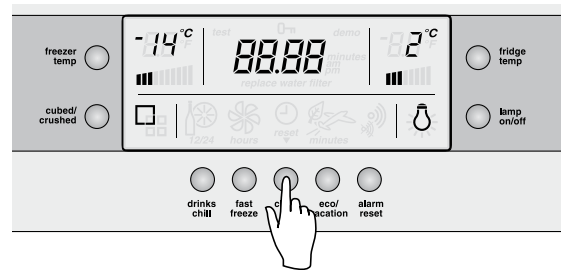

2. Press the fast freeze button to advance the hours. (Hold the button down for continuous and fast advance).
3. Press the eco/vacation button to advance the minutes. (Hold the button down for continuous and fast advance).

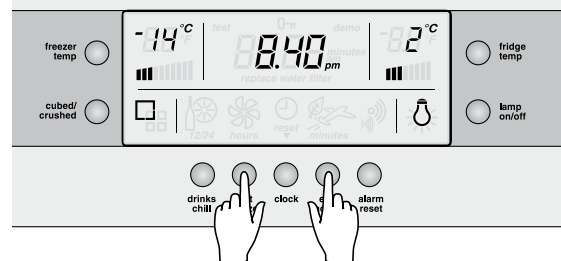

- The clock can be switched between 24 hour or 12 hour formats by pressing the drinks chill button. In 12 hour format the indicator will switch between am and pm accordingly (see diagram below).

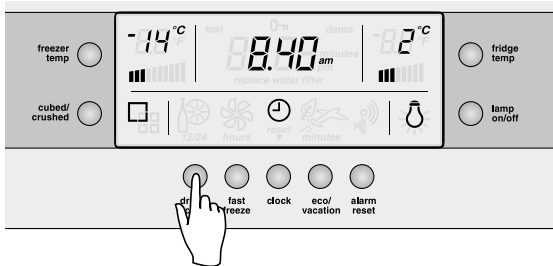

- Once the time has been set press the clock button to save the setting.

Controlling the temperature

We recommend that when you start your refrigerator for the first time, the temperature for the refrigerator is set to 3°C and the freezer to -18°C. If you want to change the temperatures, use the instructions below. You should make only small adjustments and wait 24 hours to see whether you need to make further changes.

i tips and information

When you set a temperature, you set an average temperature for the whole appliance cabinet. Temperatures inside each compartment may vary, depending on how much food you store and where you place it. High or low room temperature may also affect the actual temperature inside the appliance.

Changing the freezer temperature

Press the freezer button to make the freezer colder in 1°C steps. Once -23°C is reached the display will return to -14°C with the next button press. You'll notice that the bar graph gets smaller with colder freezer settings. If you set -14°C, the bar graph will flash continuously to warn that it is not cold enough for long term storage of frozen food.

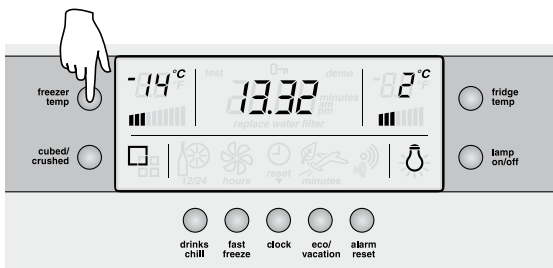

Changing the refrigerator temperature

Press the fridge button to make the fridge colder in 1°C steps. Once 0°C is reached the display will return to 7°C with the next button press. The bar graph gets smaller with colder settings.

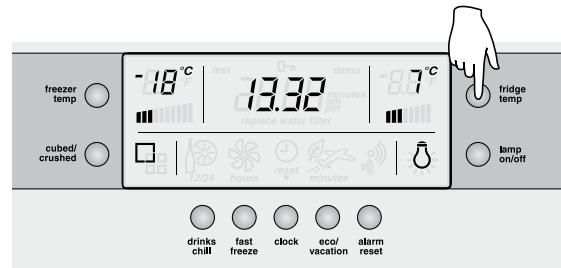

Fast freeze (quick chill) function

Use the fast freeze (quick chill) function when you add a large amount of food to the freezer compartment. This freezes the food quickly but does not affect the temperature in the refrigerator compartment.

To use this function, press the fast freeze (quick chill) button once. An animated icon will light up. The fast freeze (quick chill) function will now operate for 90 minutes. If you want to turn the fast freeze (quick chill) function off before 90 minutes have passed, simply press the fast freeze (quick chill) button again. The icon will disappear and the freezer will return to normal operation.

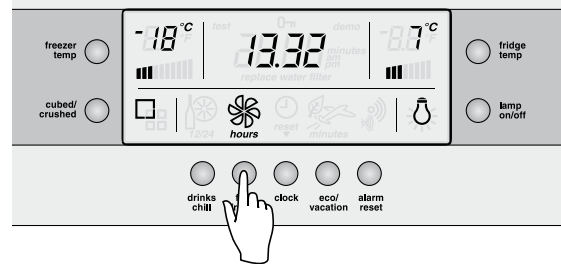

Freezer temperature alarm

If the freezer becomes too warm a buzzer will sound. The icon adjacent to the alarm reset button (on non-ice and water models) or above the alarm reset button (on ice and water models), the freezer set temperature and the bar graph will all flash until the alarm reset button is pressed. Once pressed, the alarm disable icon will illuminate for 50 minutes, or until the temperature reaches an acceptable level.

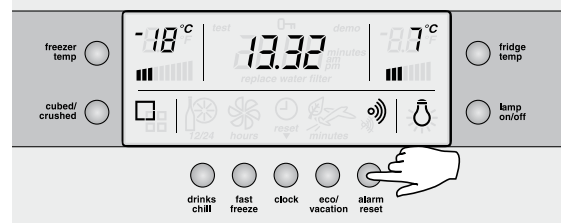

Make sure nothing is holding the freezer door open and move any warm food away from the temperature sensor (see diagrams on page 5).

If the freezer is still too warm after 50 minutes the alarm will sound again, indicating that something may be wrong with your appliance.

Note: The freezer temperature alarm can be reset for 12 hours by pressing the alarm reset button continuously for 10 seconds.

Door alarm

If the refrigerator door is left open for longer than 2 minutes a buzzer will sound and an arrow pointing to an open door will flash. The refrigerator temperature settings and bar graph will also flash.

If you want to leave the door open while you load the fridge, you can turn the alarm off for 8 minutes by pressing the alarm reset button.

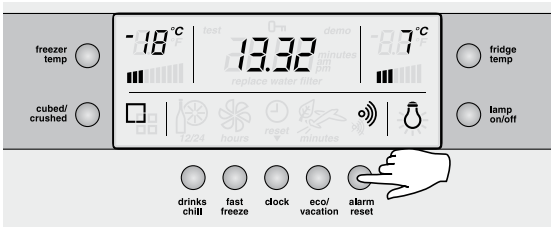

If the alarm is sounding for no apparent reason, check whether anything is holding the door open. Closing the door resets the alarm for a further 2 minutes.

Drinks chill timer

If you set the drinks chill timer it will sound an alarm to remind you that you have left drinks in your freezer for quick chilling. To use the timer, press the drinks chill button once to set a 5 minute time limit, twice for 10 minutes and up to 6 times for a 30 minute time limit. Press 7 times to turn the timer off.

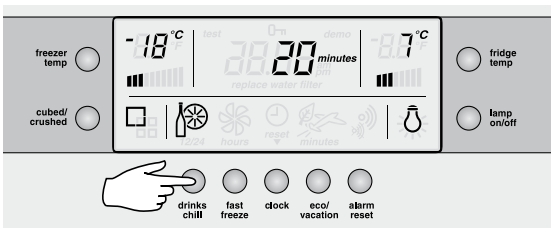

Suggested chilling times:

- 10 minutes for cans of drink
- 20 minutes for bottles of wine
- 30 minutes for bottles of soft drink

When you press the drinks chill button, an animated icon will appear beside the drinks chill button with a countdown timer. The timer will count down in 1 minute increments; you can change the time or turn the timer off even after the countdown has started. When the countdown is finished a buzzer will sound and the icon beside the alarm will flash until the alarm reset button is pressed.

To stop the alarm and turn off the drinks chill timer, press the Alarm reset button. If your drink is chilled, take it out of the freezer. If it is not cold enough, reset the drinks chill function (remembering that the drink is already partially chilled).

Child lock

To activate the child lock, press the cubed/crushed and lamp on/off buttons for 2 seconds together. This will disable the display to prevent accidental changes to settings.

The key icon will appear on the electronic display when child lock is activated. To turn off the child lock press and hold cubed/crushed and lamp on/off buttons for 2 seconds together. For standard models use the freezer temp and fridge temp buttons.

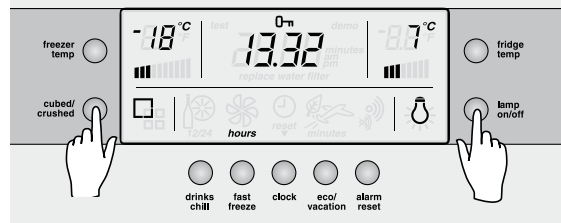

Energy efficiency

Your appliance has been designed with energy efficiency in mind and can operate in any of three modes (normal, eco, vacation), depending on the level of efficiency sought.

Normal mode

This is the mode which is entered automatically when the appliance is first turned on. Normal mode is the mode most suitable when the refrigerator door is opened often.

Eco mode

Eco mode is a more efficient mode than normal mode and can be entered in two ways. Either by manually pressing the eco/vacation button once when in normal mode, or automatically after 30 hours if the refrigerator door has not been opened. The leaf icon will appear on the electronic display when eco mode is activated. If eco mode is entered automatically, the appliance will revert to normal mode once the refrigerator door is opened. If eco mode is entered manually, door openings will not cause the display to revert to normal mode. To exit eco mode, press the eco/vacation button twice (or until there are no icons displayed).



Eco mode is designed to operate with minimum door opening (e.g. if used as a long term storage fridge). If turned on manually, it won't switch off automatically and frequent door opening in eco mode could lead to food spoilage. If frequent door opening is likely to occur switch back to normal mode.



• **Vacation (holiday) mode**

Vacation mode is suitable if you will be away from your appliance for an extended period, take advantage of maximum energy efficiency by pressing press the eco/vacation button twice in succession just before you leave (do this while in normal mode). The appliance will then enter vacation mode, as indicated by the aeroplane symbol. Press eco/vacation button again to cycle between 'normal', 'eco' and 'vacation' modes. (If in eco mode a single button press is all that is required to enter vacation mode). Vacation mode is exited automatically once the refrigerator door is opened and normal mode resumes.

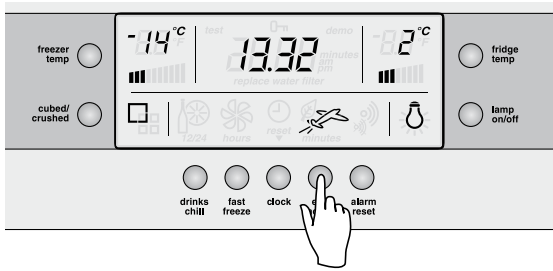

Food compartment features

Door storage bins

Both the refrigerator and freezer have door storage bins. You can adjust the door bins to meet different storage needs. All the door bins are completely removable for cleaning. If you want to remove or adjust a bin in all freezers and in the fridge of the compact side by side, lift it over the support lugs on the inner door panel. Push the bin down over the support lugs to lock it in place.

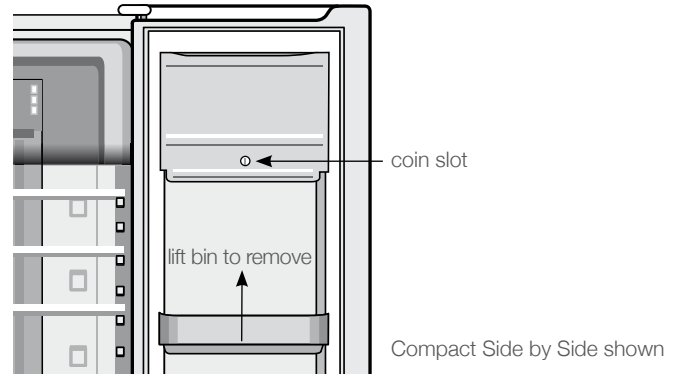

Store safe compartment (Compact Side x Side only)

The store safe compartment (diagram above) is a coin-lockable compartment. To lock, rotate the coin slot clockwise until the slot is vertical. To unlock, turn the coin slot anti-clockwise until the slot is horizontal.

Door storage bins (shelves)

Flexi-door shelving is used on the door of the large side by side. If you want to remove or adjust a bin, lift and tilt to remove. To replace, fit top and push bin down until support lugs to lock it in place.

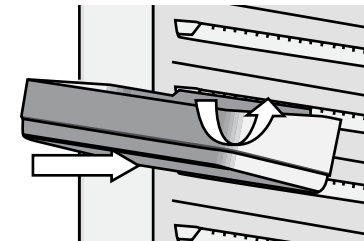

Dairy compartment

Use the dairy compartment (Compact Side by Side models only) to store foods like butter, margarine and cheeses. The compartment is slightly warmer than the rest of the refrigerator compartment, while the lid provides protection against odours.

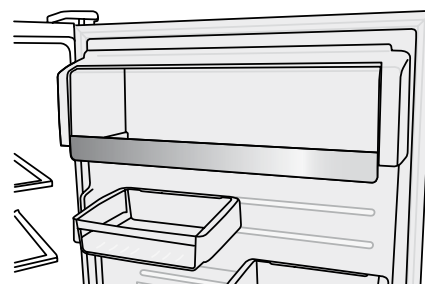

 **environmental tip**

Eco and vacation modes minimise defrosting to save energy, while maintaining your temperature settings.

Note: Opening the freezer door has no effect on the operation of Eco and Vacation Modes

Other electronic features

Other Ice and Water functions are also controlled via the display panel, these include cube and crushed ice, and turning the dispenser light on and off. Both of these functions are detailed later in this manual (refer page 11).

Your refrigerator:

- controls the compressor and fan independently to provide the best performance
- provides extra cooling depending on the number of door openings
- automatically defrosts during periods when the door is not being opened frequently

 **tips and information**

If you find that the display malfunctions, this may be due to brief power supply interruptions. If this is the problem, you simply need to turn the refrigerator off at the power point and wait 5 minutes, then turn the refrigerator on again at the power point.

Bottle twist holder operation

The bottle twist holder is used to prevent bottles from falling over. The twist holder consists of two parts, a sliding front, and a rotating retainer ring. The retainer ring can be rotated through 360° but has positive locations for horizontal and vertical positions.

The bottle twist holder can be used in two positions:

- Horizontal – when the bottle twist holder ring is horizontal, any item that fits within the ring can simply be placed inside it.

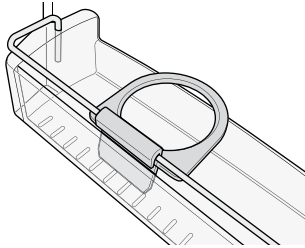

- Vertical – when the bottle twist holder ring is vertical, it is possible to simply slide the bottle twist holder along the bottle retainer bar until it is pushed up against a bottle.

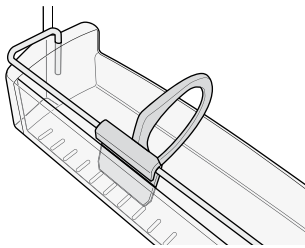

Note: The bottle should be constrained on the other side by either the end of the bin or other adjacent bottles.

Crisper bin(s)

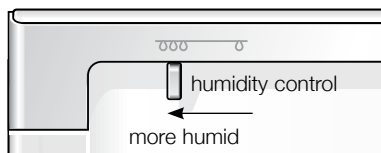

- Storing vegetables
You can use the crisper bin to store vegetables, fruit or smallgoods. You can change the humidity inside the bin by sliding the humidity control. You should store vegetables in the crisper bin remembering to set the humidity control to more humid.
- Storing fruit & smallgoods
You can also store fruit & smallgoods in the crisper bin remembering to set the humidity control to less humid.



caution

To clean a crisper cover with telescopic extension slides, simply wipe with a damp cloth and warm soapy water. Never immerse the cover in water, as this could affect the operation of the slide.

Telescopic freezer bins and crispers

For large side by sides with telescopic freezer bins and crispers you can replace the drawer as follows:

1. Push the telescopic slides in all the way.
2. Slide the drawer into place over the slides and push the bin in until it stops. The bin will not be closed all the way.
3. Open the bin to access the finger tabs at the ends of the telescopic slides, on each side of the bin. Using your thumb and forefinger, lift the bin over the end of the slide and clip in place. If the drawer is not fully engaged on the slide, it's possible the drawer won't stay on the slide if fully extended.

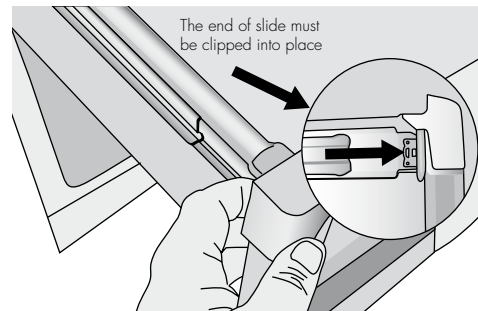

4. Fully close the bin.

When replacing the drawers after cleaning, we recommend fitting the lower drawer first.

Freezer baskets

Wire baskets are used in the compact side by side model. All the baskets pull out for easy access and have a stop to prevent the basket being pulled out too far.

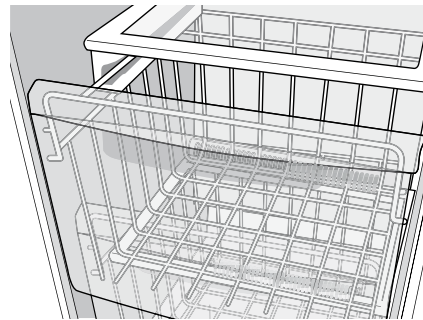

To remove the basket, pull it out until it hits the stop then lift the front to unhook the stop while continuing to pull forward, until the basket is free of the runners under the shelf.



appliancesonline
.com.au

Australia's largest online appliance retailer

Deodoriser

Your appliance is fitted with a deodoriser to assist with the removal of food odours inside your appliance. (Refer inside cover item 14).

Odours are removed by absorption through the filter by the normal operation of the appliance. Keeping food covered and wrapping food with plastic wrap will also help to reduce the odours inside your appliance.

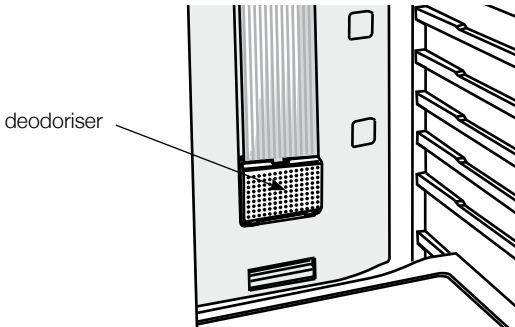

Slide away glass shelf

This shelf can be used either as a full depth shelf or when tall items need to be stored at the front of the appliance it can be collapsed to half its original depth.

- To collapse the shelf:

- To release the front half of the shelf, pull the front section of the shelf forward whilst pushing the rear edge of the front section up.

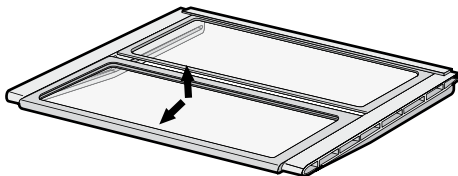

- Pull the shelf forward and allow the rear to drop into the side channels.

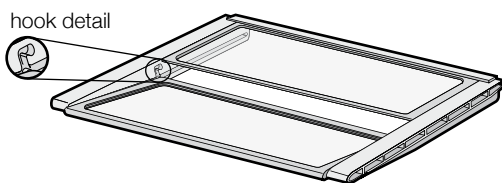

- Push the front shelf backwards until it reaches the rear stops.

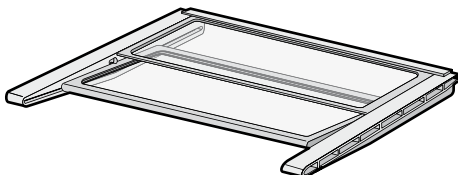

- Repositioning:

To reposition shelf, pull forward until shelf reach stops. Lift shelf clear of stops and continue to pull forwards. Once the shelf is clear of the cabinet it can be repositioned onto any of the other runners.

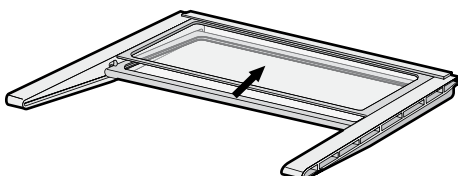

Ice and water dispenser

The ice and water dispenser conveniently dispenses cool, filtered water and ice cubes or crushed ice.

To operate the ice dispenser, select an ice option using the electronic display.

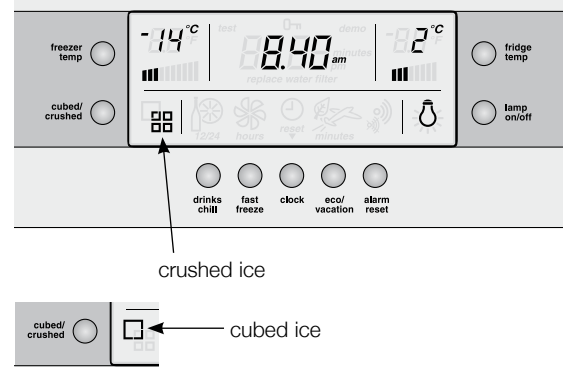

Press a glass against the dispensing paddle. Hold the top of the glass as close as possible to the ice outlet, so that you will catch all the ice. To stop dispensing ice, pull the glass away from the dispensing paddle. Do not remove the glass until the ice has finished coming out.

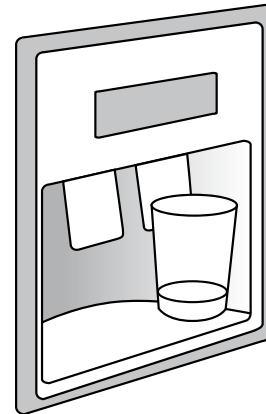

To operate the water dispenser, press a glass against the dispensing paddle. To stop dispensing water, pull the glass away from the dispensing paddle. A drip tray located at the base of the dispenser (see page 20) will catch small spills and allow them to evaporate. The drip tray is removable and dishwasher safe.



Do not pour water or excess cubes into the drip tray because it is not connected to a drain.

Dispenser lamp

The dispenser has a light which can be turned on and off by pressing the Lamp button on the electronic display (see Diagram below). The lamp is also activated for 6 seconds whenever a dispensing paddle is pressed. The light comes from 6 ultra bright LEDs (Light emitting diodes), which are part of the electronic display and are not customer replaceable.

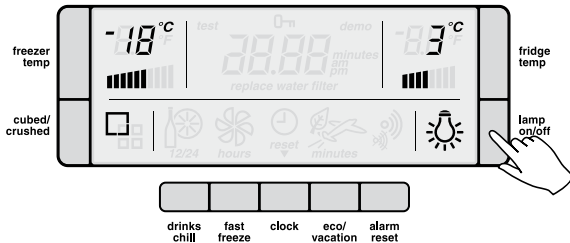

How the ice dispenser works

The ice maker and ice container are located in the top of the freezer compartment. After the refrigerator is installed properly and has cooled for several hours, the ice maker can begin making ice and the first batch will be ready within 24 hours. A full tray of ice may not be created for the first few batches, due to air in the refrigerator's new plumbing lines. To begin ice production pull out the icecream shelf and switch to the ON position ("I") then replace shelf. If no ice is dispensed it will take about 2 days to fill the storage container. The ice maker turns off automatically when the ice container is full. To stop ice production, turn the switch to the OFF position ("O") (See diagrams on page 4). The first batches of ice cubes may be discoloured or have an odd flavour, due to the refrigerator's new plumbing connections. Discard this ice until batches are free of discolouration or taste problems.

How the water dispenser works

After the refrigerator is connected to the water supply, fill the water tank by holding a glass against the dispenser paddle. You may need to hold the glass against the paddle for up to 2 minutes before water begins to flow. Continue to draw water for a further 3 minutes to rid the tank and plumbing connections of any impurities, the tank will automatically refill as you dispense water.



caution

Remember, do not drink this water as it may have impurities in it!



tips and information

The water connection to your ice and water product should only be done by a licensed refrigeration mechanic, plumber or electrician.

The water dispenser water tank is located behind the upper crisper bin in the refrigerator compartment.

Normal Operation – For cool water, add ice.

To provide the convenience of filtered water in the same location as the ice dispenser, it is necessary to route the tubes from the refrigerator compartment. This means the first half glass of water will not be quite as cold as the following 3 or 4 glasses. If you require cool water from the first glass, we recommend that you first add crushed or cubed ice to your glass then the water.

In times of high use, water may be dispensed before it has time to cool. Once this occurs, the dispensed water temperature will be similar to that of your normal tap water until the tank has had a chance to cool. The addition of cubed or crushed ice will allow you to still enjoy cool water should this occur.



caution

Chemicals from a malfunctioning softener can damage the ice maker. If the ice maker is connected to soft water, ensure that the softener is maintained and working properly.

i tips and information

- Ice cubes stored too long may develop an odd flavour. Remove the ice container and discard the ice cubes. When replacing the tray, ensure that the wire signal arm (see diagram bottom left) sits within the ice cube container. The ice maker will then start producing ice.
- Occasionally shake the ice container to keep ice separated.
- After you take delivery of the refrigerator, keep the ice maker switch in the "OFF" position until the refrigerator is connected to the water supply. The switch should also be kept in the "OFF" position whenever the water supply is turned off.

! caution

If the dispensing paddle is pushed for more than 4 minutes, the dispenser motor may overload and stop. The overload protector will reset automatically after 3 or 4 minutes.

- If a large quantity of ice is needed at one time, it is best to remove cubes directly from the ice cube container
- When the ice maker is operating, it is normal to hear the sound of:
 - the motor running.
 - ice dropping into the ice container.
 - the water valve opening or closing.
 - ice loosening in the tray.
 - running water.

Cleaning the ice dispenser

Clean the dispenser and ice container at regular intervals, particularly before you take a vacation or move, also clean the dispenser if it sticks.

To clean the dispenser:

1. Switch the ice maker switch to the "OFF" position.
2. Remove the ice container by lifting it up and out. Empty and carefully clean the container with mild detergent. Rinse carefully ensuring no traces of detergent remain. Do not use harsh or abrasive cleaners. Allow the ice container to dry completely before replacing it in the freezer.
3. Remove ice chips from the shelf and chute that support the ice container; clean these areas.
4. Replace the ice container. Ensure the wire arm sits within the ice cube container. (see diagram below)
5. Turn the ice maker switch back to the "ON" position.

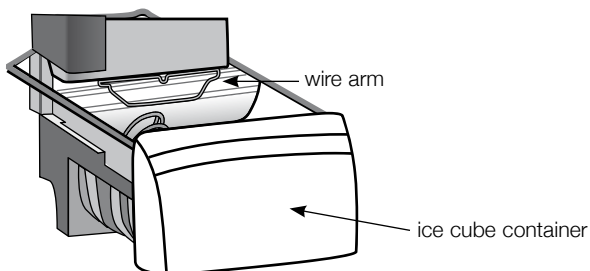

! warning

Do not use the ice chute as a handle when removing or replacing the ice storage bin. Do not put fingers up ice chute. Surfaces there may be sharp.

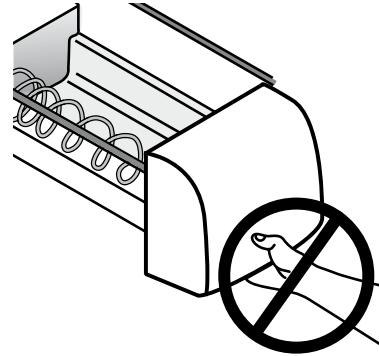

! caution

When removing or replacing the ice bin do not rotate the auger in the ice bin. If the auger is accidentally turned, you must realign the auger by turning it in 90° turns until the ice bin fits into place with the drive mechanism

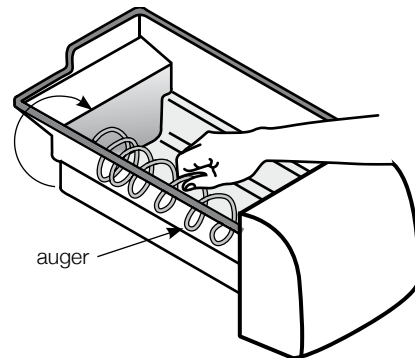

Remove and empty the ice storage bin if:

1. An extended power failure (one hour or longer) causes ice cubes in the ice storage bin to melt and freeze together and jam the dispenser mechanism.
2. If the ice dispenser is not used frequently, ice cubes will freeze together in the bin and jam the dispenser mechanism. If this happens remove the ice storage bin and shake it to loosen the cubes.

! caution

NEVER use an ice pick or similar sharp instrument to break up the ice. This could damage the ice storage bin and dispenser mechanism.

Changing the water filter

If you purchased a refrigerator with a water filter (ice and water models), please read the following care and use information.

An external water filter and connection kit has been supplied for use with your ice & water refrigerator. The external filter design allows more space within the refrigerator and provides double the life of previous filters reducing the cost of replacement. The filter is designed to significantly reduce chlorine, taste, odour, heavy metals, turbidity (cloudiness) and scale build up. The included plastic (LLDPE) water tube allows quick connection to the filter and is designed for high durability and kink resistance. This filter is designed only to be used with a potable water supply. It should not be used on water that is micro biologically unsafe or with water of unknown quality. The filter should be replaced every 12 months. The service life of the filter may be reduced in water supplies that contain an excess of particles or other impurities. Reduced flow rate is an indication that a new filter is required. Failure to replace the filter when required can affect the function of the ice maker. Service calls caused by a failure to replace the filter are not covered by warranty (see page 20).

When to change the filter

Water conditions vary throughout the world, but changing the water filter every 12 months will ensure the highest possible water quality. The electronics in your refrigerator will track the amount of water usage and advise on when the filter should be replaced. If the filter has not been in use for a while (because of a move for example), change the filter before you reinstall the refrigerator. Replacement filters can be purchased from the nearest Electrolux Service Centre (see page 20 for contact details). The filter change interval can be reset by pressing the clock button.

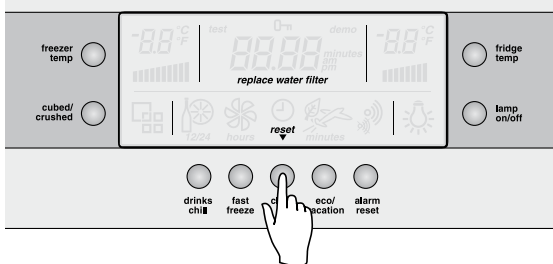

Changing the filter

Turn off water supply at the tap. Ensure that the ice maker switch is in the "O" (OFF) position.

To change the filter:

1. Turn off the water supply.
2. Release the pressure in the water lines by holding a container against the water dispenser paddle on the refrigerator until the pressure has been released.
3. Turn off the refrigerator at the power point and remove the plug from the socket.
4. Depress the collet (see illustration below) and pull the tube out of each end of the filter.
5. Refit the tubes into the new filter to the stops (about 15mm). Ensure that you observe the flow direction. Write the fitment date in the space provided on the filter.
6. Gently pull back on the tube to ensure that it is secure.
7. Turn the water supply back on and check for leaks.
8. Plug the unit back in and turn the power supply back on to the refrigerator.
9. Purge and dispose of approximately 5 litres of water through the water dispenser to condition the filter and clear the water lines of air and impurities. It may take up to a minute to get a full flow of water from the dispenser. Do not be alarmed if there is an initial black colour to the water. This is residual carbon dust from the filter and is non-toxic.
10. Once the lines have been purged, dispose of the first few batches of ice to ensure that impurities have been flushed from this part of the system.

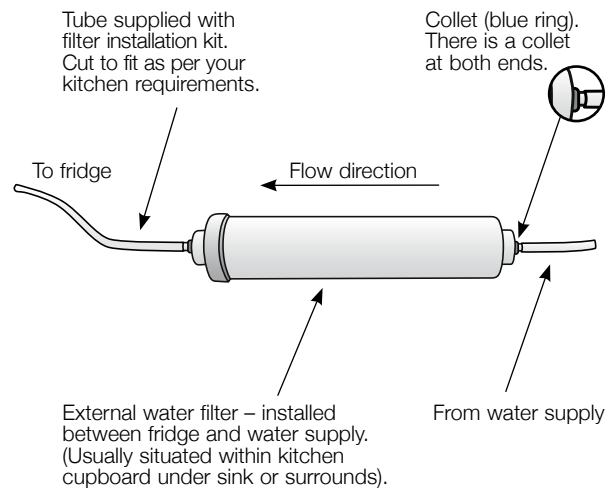

LED Lighting

Your refrigerator is fitted with long life LED lighting. In the unlikely event the LED lights should ever fail, then the LED lights need to be serviced by a qualified technician. Refer to page 20 for contact details.

Cleaning your refrigerator



BEFORE CLEANING: Turn the refrigerator off at the power point and unplug the cord to prevent any chance of electrocuting yourself.

- **Doors and exterior – stainless steel**

Your stainless steel appliance is manufactured from a mark resistant stainless steel. This stainless steel has a special advanced protective coating that eases the removal of marks such as finger prints and water spots. To keep your stainless steel appliance looking at its best, you should clean it regularly. You should only clean the stainless steel doors with luke-warm soapy water and a soft cloth, rinsing with clean water and then wipe the surface with clean water and a soft clean cloth to remove soap residue.

It is important to wipe in the direction of the grain of the stainless steel to avoid undue marking of the surface.

- **Doors – surface hardened acrylic**

You should only clean the acrylic doors with lukewarm soapy water and a soft cloth, rinsing with clean water and the wipe the surface with clean water and a soft clean cloth to remove soap residue.



Do not use abrasive pads or other cleaners as they are likely to scratch the surface. Damage to this product after installation is not covered by your warranty.

Drip Tray (Ice & Water models only)

Water may accumulate in the sump located under the drip tray. If this occurs the sump can be sponged out to prevent water overflowing down the front of the door.

For cleaning, remove the tray as described below:

1. Insert a lever (e.g. spoon handle) in the opening in the drip tray.
2. Whilst holding the front of tray, lever the back upwards.
3. To refit, position the front of the tray into the front of the sump then lower the back of the tray.

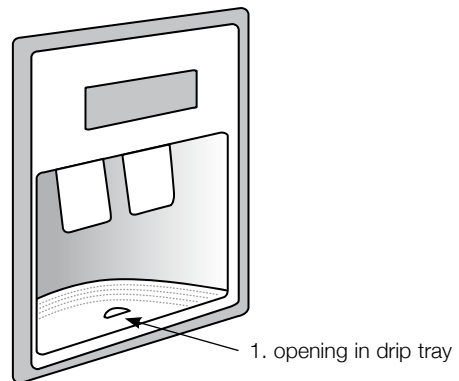

Energy consumption (electricity costs)

Cleaning the interior

You should clean the refrigerator interior regularly. It will be easiest to clean when the food supply is low. Wash the interior with a soft cloth and use an unscented mild soap with lukewarm water. Thoroughly dry all surfaces and removable parts. Avoid getting water on refrigerator controls. If you have taken out any removable parts, replace them and switch the power on before restocking the refrigerator with food. You should keep the interior of your refrigerator hygienic by promptly and thoroughly wiping up any food spills.

Keep door seals clean

Take care to keep door seals clean. Sticky food and drink can cause seals to stick to the cabinet and tear when you open the door. Wash the seal with a mild detergent and warm water. Rinse thoroughly with clean water and dry.



caution

Never use hot water, solvents, commercial kitchen cleaners, aerosol cleaners, metal polishes, caustic or abrasive cleaners, or scourers to clean this appliance as they will damage it.

Many commercially available cleaning products and detergents contain solvents that will damage your refrigerator. When cleaning, use only a soft cloth with an unscented mild soap and lukewarm water.

The following guide will help you reduce the running cost of your new refrigerator. This will save you money and help conserve our valuable energy resources.

1. If you keep your old refrigerator, save power by switching it off when not in use.
2. Do not set your freezer temperature too low. After 24 hours, ice cream should be firm but able to be scooped out with a spoon without bending the handle. If ice cream is firmer than this (or too soft), adjust the freezer temperature controls (see 'Controlling the Temperatures', page 6).
3. Ensure that the refrigerator doors seal properly as you close them.
4. Before you open the refrigerator doors, decide what you want to put in or take out. This will minimize the time you have the doors open.
5. It is best to have the refrigerator in a place that is out of direct sunlight and away from heating appliances of any kind. For example, do not place the refrigerator next to a cooker, stove or dishwasher.
6. Allow hot foods to cool to room temperature before you put them in your freezer.
7. Thaw frozen food in the refrigerator section.
8. If you keep the freezer compartment filled to capacity, your food mass will help maintain the freezer temperature when you open the door.
9. Do not block air vents. Doing so may cause the refrigerator to run longer and use more energy.

Switching off the refrigerator

If you are leaving for a short holiday, there is no need to turn off your refrigerator – use eco/vacation or eco mode (page 7). If you are going on a long holiday and want to turn the refrigerator off, follow the steps below.

1. Take all the food out of the refrigerator and freezer compartments.
2. Switch off the refrigerator and remove the electric cord from the power point.
3. Clean the inside.
4. Leave the doors open. This prevents bacteria from growing and causing smells in the refrigerator.

Power failure

If there is a power failure in your area, keep the door to the freezer closed. Most foods in your freezer will stay frozen for 24 hours.



appliancesonline
.com.au

Australia's largest online appliance retailer

Safety

Safety

It is important to use your appliance safely. This means you need to supervise young children and infirm persons when they use it. You need to make sure that young children do not play with the appliance. Follow the tips below.

| always do this |
|--|
| ✓ Check the power point is properly earthed - if you are not sure get an electrician to check it. |
| ✓ Switch off the appliance at the power point before you clean or move it. |
| ✓ If the supply cord is damaged you should have it replaced by the manufacturer, it's service agent or similarly qualified person. |
| ✓ If the LED lights fail you should have it serviced by the manufacturer, it's service agent or similarly qualified person. |
| never do this |
| ⊘ Never let children play with the appliance. |
| ⊘ Never store spray cans, explosive liquids or flammable liquids in the refrigerator. |
| ⊘ Never store fizzy drinks in the freezer compartment. |
| ⊘ Never lick icy foods when they first come out of the freezer. This can freeze burn your lips and mouth. |
| ⊘ Never try to repair the appliance yourself. |
| ⊘ Never use electric heaters or dryers to defrost the freezer because you can receive an electric shock. |
| ⊘ Never use electrical appliances inside the food storage areas. |
| ⊘ This appliance contains insulation formed with flammable blowing gases. For safety reasons, take care when you dispose of it. |
| ⊘ Do not damage the appliance circuit. |
| ⊘ Do not damage the refrigerant circuit. |
| ⊘ Do not use mechanical devices or other means to accelerate the defrosting process, other than those recommended by the manufacturer. |



warning

When you dispose of your old refrigerator or freezer, remove any doors. Children can suffocate if they get trapped inside.

Helpful hints

Helpful hints for storing food

| always do this |
|--|
| ✓ Buy the freshest, best quality food and put it in the refrigerator as soon as possible. |
| ✓ Cover food with plastic wrap or foil to stop it drying out and to help prevent bad smells. |
| ✓ Rinse and wrap fish and poultry before you put them in the refrigerator. |
| ✓ Minimise bacteria by removing stuffing from poultry before you put it in the refrigerator. |
| ✓ When you store eggs in the refrigerator compartment, store them with the pointed end down. |
| never do this |
| ⊘ Store bananas, avocados or mangoes in the refrigerator. This can cause them to go black or to go soft. |
| ⊘ Put hot or warm food in the refrigerator. Allow it to cool first. |

Helpful hints for freezing food

You can use the freezer to store food which you buy in bulk when prices are low. You can also cook extra food and freeze it for later use.

| always do this |
|---|
| ✓ Buy the freshest, best quality food and put it in the freezer as soon as possible. |
| ✓ Place food in plastic bags or plastic wrap before you put it in the freezer. |
| ✓ Squeeze the air out of plastic bags as this prevents frost. |
| ✓ When you buy frozen foods in the supermarket, keep them in their packaging when you store them. |
| ✓ Defrost food, especially chicken and fish, in the refrigerator compartment. This stops bacteria from growing. |
| ✓ Leave food in its wrapping while it defrosts. |
| ✓ Use defrosted food immediately. |
| never do this |
| ⊘ Never refreeze defrosted food. |

Troubleshooting

If you think something may be wrong with your refrigerator, you can carry out some easy checks before calling for service. You may locate the problem, sparing yourself any inconvenience and saving time and money.

| problem | solution |
|--|--|
| When your appliance is not operating | <ul style="list-style-type: none"> • Check that the power cord is plugged into the power outlet properly and that the outlet is switched 'ON'. • Try running another appliance from the power outlet. If no power is coming from the outlet you may have blown a fuse or tripped a circuit of your household power supply. • Try adjusting the temperature control to a slightly "colder" position. • It is normal for the freezer fan NOT to operate during the automatic defrost cycle, or for a short time after the appliance is switched on. |
| When there is refrigerator/freezer noise | <p>Modern refrigerators/freezers with increased storage capacity use high speed compressors. These can provide a seemingly high level of sound which is quite normal. Normal operational sounds include:</p> <ul style="list-style-type: none"> • Occasional gurgling, similar to water boiling. • Air flow noise (air circulates because of a small fan). • A popping noise heard during automatic defrost. • A clicking noise heard just before the compressor starts (this is merely the automatic switching action of the temperature control, turning the compressor on or off). <p>Other strange sounds may mean that you need to check and take action. For example, noises may mean that:</p> <ul style="list-style-type: none"> • The cabinet is not level. • The floor is uneven or weak. • Bottles are badly placed and rattling. • There are vibrations from an object on top of or behind or beside the refrigerator. • The back of the refrigerator cabinet is touching the wall. <p>Remember it is quite normal for noise to seem louder just after the refrigerator starts operating.</p> |
| If there are odours inside the appliance | <ul style="list-style-type: none"> • The interior may need cleaning. • Some foods produce odours. • Some containers and wrapping can cause odours. • Ask yourself if the odour started about the same time you started storing something unusual. |

| problem | solution |
|--|---|
| When the motor seems to run more than expected | <p>Your new appliance provides you with large capacities in both the refrigerator section and the separate freezer. It is normal for the motor to operate frequently. However, to keep operation to a minimum, check the following:</p> <ul style="list-style-type: none"> • Are doors kept open too long or too often? • Are controls set too cold? See "Controlling temperature" (refer page 5). • Have large amounts of warm food just recently been stored? Summer, festive seasons and holidays usually mean a lot more work for your appliance. • If the day is hot or the room is very warm, the appliance will need to run more than normal. • The appliance will run more than normal just after you install it or when it has been turned off for a long time. |
| If the temperature in the refrigerator is too warm | <ul style="list-style-type: none"> • Check that the appliance has enough clearance at the sides, back and top. Refer to the installation Instructions at the front of this booklet. • Refer to "Controlling the temperature" (refer page 5). • You may have kept the door open too long or too frequently. • Food containers or packaging may be holding a door open. |
| If the temperature in the refrigerator is too cold | <ul style="list-style-type: none"> • Refer to "Controlling the temperature" (refer page 5). • Increase the temperature to avoid high energy consumption. |
| If heavy frosting occurs in the freezer | <p>Make sure you fully close the freezer and fridge doors. If the doors are left partly open a heavy frost will coat the inside of the freezer. If a frost develops, remove it. Take care to properly close the doors and the frost will not reoccur.</p> |
| If water drips on the floor | <p>The defrost water tray, (located at the back or underneath of the cabinet), may not be properly positioned, or the drain tube may not be properly positioned to direct water into this tray. You may need to pull the refrigerator away from the wall to check the tray and tube.</p> |
| Fridge does not exit vacation mode | <p>Turn appliance off at the powerpoint. Leave off for five (5) minutes for the memory to clear, then turn back on.</p> |
| if your electronic display does not respond. | <p>If no buttons have been pressed for approx. 60 seconds there may be a delay of up to 2 seconds before the display reacts. This is normal and is to prevent accidental changes to the settings.</p> |

Troubleshooting

Ice maker problem checklist

| problem | possible causes | solution |
|---|--|--|
| automatic ice-maker | | |
| The ice maker is not making any ice | • Ice maker is in the OFF position | • Put switch in the ON position |
| | • Water tap is turned off | • Turn on the water tap |
| | • The freezer is not cold enough | • See the PROBLEM section: "IF THE TEMPERATURE IN THE REFRIGERATOR IS TOO WARM." on page 17 |
| | • The water dispenser may not be dispensing water | • If it isn't, the ice & water filter cartridge may be clogged or restricted by foreign material, and will need to be replaced |
| | • Filter may be blocked | • Check and/or change filter |
| The ice-maker is not making enough ice | • The ice maker is producing less ice than you expect | • The ice maker should produce approximately 2–3 kilograms of ice every 24 hours |
| | • The freezer is not cold enough | • See section 'Controlling Temperatures' on pages 6 |
| | • Household water tap is not open | • Open the household water tap |
| | • The water dispenser is dispensing slower than normal | • Replace the water filter cartridge |
| Ice cubes are hollow or smaller than normal | • Restricted water flow to the ice maker | • Replace the filter cartridge, as the water filter cartridge may be clogged. |
| The ice has a bad odour and taste | • The ice has picked up odour or flavour from strongly flavoured food stored in the refrigerator or freezer | • Cover foods tightly. Discard stale ice. The ice maker will produce a fresh supply • Change ice monthly |
| | • The water running into the ice maker has poor taste or colour | • Add a filter to water supply line. Consult a water purifying company |
| | • Ice not used frequently enough | • Discard stale ice monthly |
| ice dispenser | | |
| The dispenser will not dispense ice | • The ice storage container is empty | • When the first supply of ice drops into the container, the dispenser should operate. |
| | • Household water tap is not open | • Open the household water tap. Allow sufficient time for the ice to be made. When ice is made the dispenser should operate |
| | • The wire signal arm is either held or jammed | • Remove jam or free arm |
| | • Ice maker switch is in OFF position | • See ice maker section in user manual. Turn switch to ON position |
| The ice dispenser is jammed | • Ice has melted and frozen around the auger due to infrequent use, temperature fluctuations, and/or power outages | • Remove the ice container and empty it's contents. Clean and dry the container and replace to its proper position. When new ice is made, the dispenser should operate |
| | • Ice cubes are jammed between the ice maker and back of ice container | • Remove ice cubes that are jamming dispenser |
| | • Ice cubes are frozen together | • Use the dispenser often so that cubes do not freeze together • Discard ice monthly |
| | • Ice cubes are hollow or smaller than normal | • The water filter cartridge could be clogged. Cartridge may need replacing |

If you still require service

If you have a problem, and the problem persists after you have made the checks mentioned above, contact your nearest Electrolux approved Service Centre or dealer from whom you bought the refrigerator. Be ready to quote the model number and 8-digit serial number, which is stated on the label inside the refrigerator compartment.

Electrolux Warranty

FOR SALES IN AUSTRALIA AND NEW ZEALAND
APPLIANCE: ELECTROLUX S DE BY SIDE REFRIGERATOR

This document sets out the terms and conditions of product warranties for Electrolux branded appliances. It is an important document. Please keep it with your proof of purchase documents in a safe place for future reference should you require service for your Electrolux appliance.

General Terms and Conditions

1. In this warranty
 - (a) 'Electrolux' means Electrolux Home Products Pty Ltd ABN 51 004 762 341 in respect of Appliances purchased in Australia and Electrolux (NZ) Limited in respect of Appliances purchased in New Zealand;
 - (b) 'Appliance' means any Electrolux product purchased by you accompanied by this document;
 - (c) 'Warranty Period' means
 - (i) where you use the Appliance for personal, domestic or household purposes in Australia the period of '24' months and in New Zealand the period of '24' months;
 - (ii) where you use the Appliance for commercial purposes, in Australia the period of '3' months and in New Zealand the period of '3' months, (if the period stated is 0 months you are not covered by this product warranty) following the date of original purchase of the Appliance;
 - (d) 'you' means the purchaser of the Appliance not having purchased the appliance for re-sale, and 'your' has a corresponding meaning.
2. This warranty only applies to Appliances purchased and used in Australia or New Zealand and is in addition to (and does not exclude, restrict, or modify in any way) any non-excludable statutory warranties in Australia or New Zealand.
3. Electrolux warrants that, when dispatched from an Electrolux warehouse, the Appliance is free from defects in materials and workmanship for the Warranty Period.
4. During the Warranty Period Electrolux or its Authorised Service Centre will, at no extra charge if your appliance is readily accessible without special equipment, and subject to these terms and conditions, repair or replace any parts which it considers to be defective. You agree that any replaced Appliances or parts become the property of Electrolux. This warranty does not apply to light globes, batteries, filters or similar perishable parts.
5. Parts and Appliances not supplied by Electrolux are not covered by this warranty.
6. Where you are within an Electrolux service area, this warranty covers the cost of transport of the Appliance to and from Authorised Service Centres of Electrolux and travelling costs for representatives of the Authorised Service Centre to and from your home or business. If you are outside an Electrolux service area, you will bear these costs. For information about whether you are within an Electrolux service area, please phone 13 13 49 in Australia, or 0800 10 66 10 in New Zealand.
7. Proof of purchase is required before you can make a claim under this warranty.
8. You may not make a claim under this warranty unless the defect claimed is due to faulty or defective parts or workmanship. Electrolux is not liable in the following situations (which are not exhaustive):
 - (a) The Appliance is damaged by:
 - (i) accident
 - (ii) misuse or abuse, including failure to properly maintain or service
 - (iii) normal wear and tear
 - (iv) power surges, electrical storm damage or incorrect power supply
 - (v) incomplete or improper installation
 - (vi) incorrect, improper or inappropriate operation
 - (vii) insect or vermin infestation.
 - (b) The Appliance is modified without authority from Electrolux in writing.
 - (c) The Appliance's serial number or warranty seal has been removed or defaced.
 - (d) The Appliance was serviced or repaired by anyone other than Electrolux or its Authorised Service Centres.
9. This warranty, the contract to which it relates and the relationship between you and Electrolux are governed by the law applicable in the Australian State where the Appliance was purchased or the law applicable in New Zealand if the Appliance was purchased in New Zealand. Where the Appliance was purchased in New Zealand for business purposes the Consumer Guarantee Act does not apply.

Limitation of Liability

10. To the extent permitted by law:
 - (a) Electrolux excludes all warranties other than as contained in this document;
 - (b) Electrolux shall not be liable for any loss or damage whether direct or indirect or consequential arising from your purchase, use or non-use of the Appliance.
11. Provisions of the Trade Practices Act and State consumer legislation in Australia, and the Consumer Guarantees Act, the Sale of Goods Act and the Fair Trading Act in New Zealand, imply warranties or conditions, or impose obligations, upon Electrolux which cannot be excluded, restricted or modified. To the extent permitted by law, the liability of Electrolux (if any) arising out of or in relation to the Appliance or any services supplied by Electrolux shall be limited (where it is fair and reasonable to do so):
 - (a) in the case of Appliances, at its option, to the replacement or repair of the Appliances or the supply of equivalent products or the payment of the cost of replacing the Appliances or having the Appliances repaired or of acquiring equivalent Appliances. Upon being replaced, parts and Appliances become the property of Electrolux; or
 - (b) in the case of services, at its option, to the supply of the services again or the payment of the cost of having the services re-supplied; and in the case of Appliances or services supplied in New Zealand, loss or damage whether direct or indirect or consequential that is reasonably foreseeable.

Privacy

You acknowledge that in the event that you make a warranty claim it will be necessary for Electrolux and its Authorised Service Centres to exchange information in relation to you to enable Electrolux to meet its obligations under this warranty.

EXTENDED WARRANTIES AND INDEMNITY

Sealed Refrigeration System Warranty

For a further period of three years following the expiry of the Warranty period, Electrolux or its agent will supply replacements for, or at the sole option of Electrolux, repair, all parts it finds defective in the Sealed Refrigeration System which comprises: compressor, condenser, evaporator, dryer and tubing. During this three year period you will pay for the costs of labour (including any call out or service fees), and freight if necessary in replacing defective parts in the Sealed Refrigeration System. You will pay for the costs of transport of the Appliance if further service is required and the costs of parts or repairs to parts other than those included in the Sealed Refrigeration System

Frozen Food indemnity

Subject to the following exclusions, Electrolux will indemnify you for a period of 24 months from the date of purchase of the Appliance against any loss or damage to frozen foodstuffs due to a Sealed Refrigeration System breakdown. This indemnity will be limited to:

- (a) in the case of freezers with a capacity of less than 400 litres – AU\$150
- (b) in the case of freezers with a capacity of 400 litres or more – AU\$300

 This indemnity does not cover loss or damage to frozen foodstuffs occasioned by:

- (a) failure to plug in the freezer to a properly connected power supply or failure to switch on the power point
- (b) accidental removal of the plug from the power point or switching off the power supply;
- (c) failure to keep the door or lid of the freezer closed
- (d) the introduction of abnormal heat loads to the freezer;
- (e) failure to observe the operating and installation instructions supplied with the freezer; and
- (f) failure to defrost the freezer at recommended intervals on chest freezers or non frost free models

Important Notice

Before Calling a Service Technician please check carefully the operating instructions, service booklet and the warranty terms and conditions.

| | | |
|--|---|---|
| <p>FOR SERVICE or to find the address of your nearest state service centre in Australia PLEASE CALL 13 13 49 For the cost of a local call (Australia only)</p> | <p>SERVICE AUSTRALIA  ELECTROLUX HOME PRODUCTS www.electrolux.com.au</p> | <p>FOR SPARE PARTS or to find the address of your nearest state spare parts centre in Australia PLEASE CALL 13 13 50 For the cost of a local call (Australia only)</p> |
| <p>FOR SERVICE or to find the address of your nearest authorised service centre in New Zealand FREE CALL 0800 10 66 10 (New Zealand only)</p> | <p>SERVICE NEW ZEALAND  ELECTROLUX HOME PRODUCTS www.electrolux.co.nz</p> | <p> FOR SPARE PARTS or to find the address of Australia's largest online appliance retailer state spare parts centre in New Zealand FREE CALL 0800 10 66 20 (New Zealand only)</p> |

Electrolux Home Products Australia

telephone: 1300 363 640

fax: 1800 350 067

email: customercare@electrolux.com.auweb: www.electrolux.com.au**The Thoughtful Design Innovator.**

Do you remember the last time you opened a gift that made you say, "Oh! How did you know? That's exactly what I wanted!" That's the kind of feeling that we at Electrolux seek to evoke in everyone who chooses or uses one of our products. We devote time, knowledge, and a great deal of thought to anticipating and creating the kind of appliances that our customers really need and want.

This kind of thoughtful care means innovating with insight. Not design for design's sake, but design for the user's sake. For us, thoughtful design means making appliances easier to use and tasks more enjoyable to perform, freeing our customers to experience the ultimate 21st century luxury: ease of mind. Our aim is to make this ease of mind more available to more people in more parts of their everyday lives, all over the world.

The "Thinking of you" promise from Electrolux goes beyond meeting the needs of today's consumers. It also means we're committed to making appliances safe for the environment – now and for future generations.

Electrolux. Thinking of you.

Share more of our thinking at www.electrolux.com.au

P/No. 1455456

© Copyright 2009 Electrolux Home Products Pty Ltd
ABN 51 004 762 341

Print code: EFRISXSUM
Issue date: Sep 09