



COMMERCIAL DESIGN GUARANTEED PERFORMANCE

CONICAL BURR COFFEE GRINDER

Instruction Booklet

Please read these instructions carefully and retain for future reference



EM0480

Contents

Sunbeam's Safety Precautions	2
Congratulations	3
Features of your Café Series™ Conical Burr Coffee Grinder	4
Functions of your Café Series™ Conical Burr Coffee Grinder	6
Operating your Café Series™ Conical Burr Coffee Grinder	7
Adjusting the Grind Setting	9
Care and Cleaning	10

Important instructions – retain for future use.

تأكد من تفهم احتياطات السلامة المذكورة اعلاه

請務必理解上述的安全預防措施。

Assurez-vous que les précautions ci-dessus relatives à la sécurité sont bien comprises

Versichern Sie sich daß die obenstehenden Sicherheitsmaßnahmen Verstanden werden

Βεβαιώστε πως οι παραπάνω προφυλάξεις ασφαλείας γίνονται κατανοητές

Pastikan bahwa tindakan-tindakan keselamatan seperti di atas dimengerti anda

Accertatevi che le suddette norme di sicurezza siano comprese a dovere

上記の注意事項をよくお読みになり、安全を御確認ください

Уверете се дека погоре споменатите мерки на претпазливост се добро разбрани

Asegúrese de que las precauciones de seguridad precedentes sean bien comprendidas

کاری بکنید کہ احتیاط‌های بالا حتماً درک بشوند

ต้องแน่ใจว่า ข้อควรระวังเรื่องความปลอดภัยข้างต้น เป็นที่เข้าใจกันดี

Yukarda belirtilen güvenlik önlemlerinin anlaşıldığından emin olunuz

Xin kiểm chắc rằng những biện pháp làm an toàn kể trên được hiểu rõ

Sunbeam's Safety Precautions

SAFETY PRECAUTIONS FOR YOUR SUNBEAM COFFEE GRINDER

- Check the grinding bowl for the presence of foreign objects before using.
- Always operate the grinder with the ground coffee container properly inserted in the grinder.
- Do not place your hand in or near the burrs while the grinder is in operation.
- Always place the unit on a flat, level surface.
- Switch off and unplug at power point before cleaning.
- Do not attempt to re-grind ground coffee.

Sunbeam are very safety conscious when designing and manufacturing consumer products, but it is essential that the product user also exercise care when using an electrical appliance. Listed below are precautions which are essential for the safe use of an electrical appliance:

- Read carefully and save all the instructions provided with an appliance.
- Always turn the power off at the power outlet before you insert or remove a plug. Remove by grasping the plug - do not pull on the cord.
- Turn the power off and remove the plug when the appliance is not in use and before cleaning.
- Do not use your appliance with an extension cord unless this cord has been checked and tested by a qualified technician or service person.
- Always use your appliance from a power outlet of the voltage (A.C. only) marked on the appliance.
- This appliance is not intended for use by young children or infirm persons unless they have been adequately supervised by a responsible adult to ensure that they can use the appliance safely.
- Young children should be supervised to ensure that they do not play with the appliance.
- Never leave an appliance unattended while in use.
- Do not use an appliance for any purpose other than its intended use.
- Do not place an appliance on or near a hot gas flame, electric element or on a heated oven. Do not place on top of any other appliance.
- Do not let the power cord of an appliance hang over the edge of a table or bench top or touch any hot surface.
- Do not operate any electrical appliance with a damaged cord or after the appliance has been damaged in any manner. If damage is suspected, return the appliance to the nearest Sunbeam Appointed Service Centre for examination, repair or adjustment.
- For additional protection, Sunbeam recommend the use of a residual current device (RCD) with a tripping current not exceeding 30mA in the electrical circuit supplying power to your appliances.
- Do not immerse the appliance in water or any other liquid unless recommended.

If you have any concerns regarding the performance and use of your appliance, please visit www.sunbeam.com.au or contact the Sunbeam Consumer Service Line.

Ensure the above safety precautions are understood.

Congratulations

Congratulations on the purchase of your Sunbeam Café Series™ Conical Burr Coffee Grinder.

The Sunbeam Café Series™ delivers quality, style and superior performance capturing the essence of the commercial kitchen. Inspired by heavy-duty equipment found in restaurants, cafes and bars, the Sunbeam Café Series™ is built to last. It brings together a range of appliances designed to expertly create authentic café food and beverages at home.

Uncompromising blends of stainless steel, brass and die-cast alloy characterise the range. This combined with advanced technology and functional design, guarantee the performance, that each product will surpass expectations.

When making coffee regardless of the brewing method the flavour of the resulting brew depends largely on the quality, freshness and roast of the coffee being used. Other factors including the purity of the brew water, condition of the grinder and the actual design of the burrs within the grinder can also affect the taste of the final cup.

The Sunbeam Café Series grinder features tool hardened steel conical burrs for extra long life. Inherent from the conical burr design is homogenous grinding so the particle size of the coffee is consistent and even. This is especially important for espresso, if the particle size of the coffee is uniform equal amounts of the coffee's aromatic profile will be extracted. However if the particle size of the coffee varies some particles will be over-extracted and some will be under-extracted, resulting in a poor tasting coffee.

Another advantage of the conical burr design is its slow rotating operation. This combined with a gear-driven motor, minimises heat transfer to the burrs and thus protects the aromatic profile of the coffee and ultimately enhances the quality of the resulting brew.

The Sunbeam Café Series™ Conical Burr Coffee Grinder is designed with quality die-cast metal components and includes many features that make grinding coffee at home easy so you can enjoy a lovely fresh cup of coffee every time. We hope you enjoy your new coffee grinder and should you need any further assistance please don't hesitate to contact the Sunbeam Consumer Hotline on Free Call

Australia
1800 025 059

New Zealand
0800 786 232

Features of your Café Series™ Conical Burr Coffee Grinder

250g Bean hopper

The 250g capacity bean hopper has a shutter release mechanism for easy removal and preventing accidental spills. It allows the user to transfer any un-used beans to an ideal storage unit to preserve freshness.

Grind adjustment collar

Large and easy to use, the collar has a wide-range of 24 grind settings. The coffee maker can select a fine grind to suit commercial espresso or adjust the setting for other brewing styles – from Turkish to plunger. With such precise settings the user controls the particle size and ultimately the quality of the brew.

Group handle locator

Ground coffee container

Preparation mat

Positioned under the grinding spout the preparation mat is ideal for catching loose coffee grinds while filling directly into the group handle. The mat can also be used on the bench as a tamping pad.

Rubber feet

The non-slip rubber feet ensure the grinder remains stable and prevents slipping on the bench top during use.

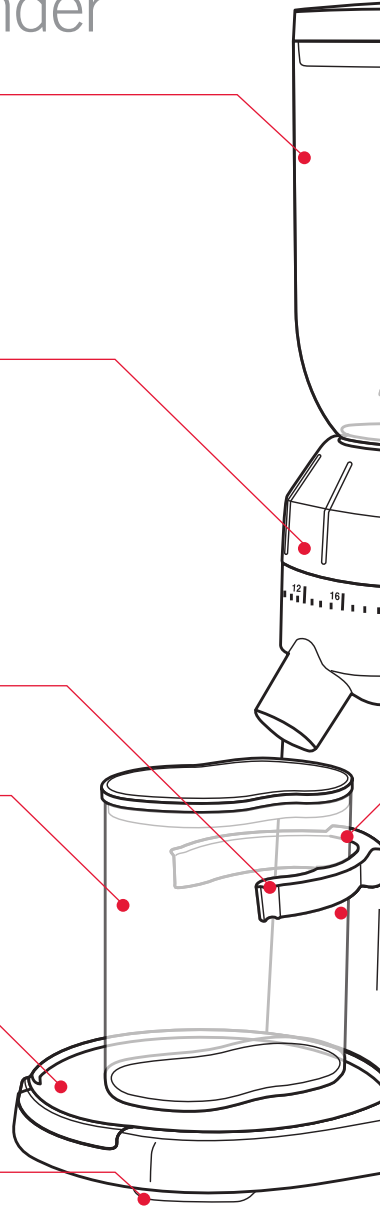

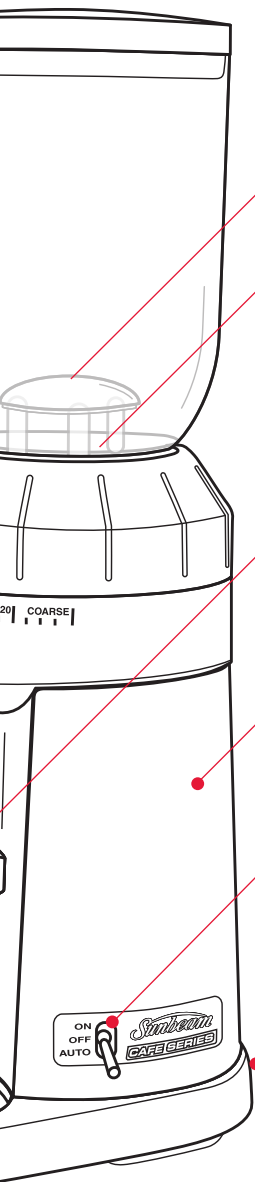

Burr shield

Italian conical burrs

Italian designed and manufactured, the metal conical burr design achieves excellent grind consistency and minimises heat transfer to the coffee due to the slowly rotating burrs.

Grind on demand button

Position the group handle into the group handle locator, push against the button and freshly ground coffee will flow directly into the basket, pull the handle away and grinding will stop.

Die-cast metal housing

Built to last, the heavy-duty die-cast metal body encases a powerful motor, supported by a 5 year guarantee and provides a stable base for the grinder.

Operation switch

Switch to 'On' to grind continuous quantities directly into the storage container, 'Off' to stop or alternatively switch to 'Auto' for grinding directly into the group handle.

Cord wrap

Cord wraps away to keep bench top clean.

Burr cleaning brush

Strong bristles help sweep out grinds from the burrs.

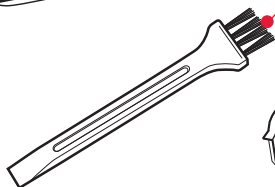

**Commercial size
group handle locator**



**Domestic size
group handle locator**

Functions of your Café Series™ Conical Burr Coffee Grinder

Slow speed grinding

The combination of a powerful gear-driven motor and conical burr design delivers a slow speed grinding process. This minimises the heat transferred to the coffee, protecting its aromatic profile.

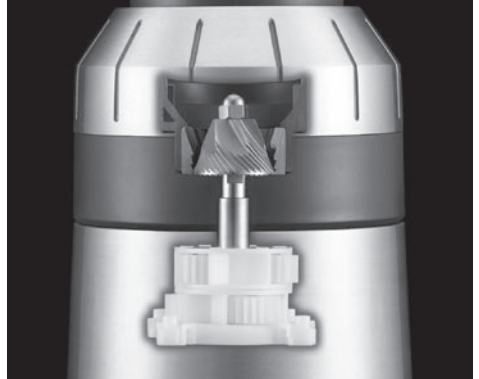

Dual mode settings

For convenience there are two methods of operation – the 'Auto' function for grinding coffee as it's required or 'On' for grinding continuous quantities directly into the storage container.



Grind on demand

As with commercial bar grinders, the 'Auto' function allows coffee beans to be freshly ground directly into the group handle on demand as required by the coffee maker, providing complete dosing control and most importantly a fresh grind without loss of aroma and flavour.



Operating your Café Series™ Conical Burr Coffee Grinder

Before using the coffee grinder, wipe the base exterior with a damp cloth. Wash the bean hopper, hopper lid and ground coffee container in warm soapy water, then rinse and dry.

Note: Do not immerse the burrs in water or any other liquid.

Note: Do not place any parts of the coffee grinder in the dishwasher.

1. Place the coffee grinder on a dry, level surface.
2. To attach the bean hopper, position bean hopper onto the top of the motor base, push down and turn clockwise. See figure 1.

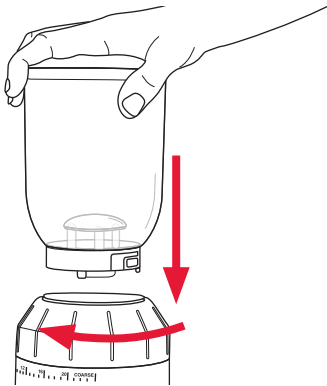

Figure 1

3. Fill the bean hopper with coffee beans.

Tip: Remember to keep the hopper full at all times. Having an even weight bearing down on the burrs is important to ensure a consistent grind.

Note: This coffee grinder is intended to grind whole coffee beans only.

4. Place the hopper lid onto the bean hopper.
5. Plug the power cord into a 230-240V AC power outlet and switch the power on.

6. Select the grind by turning the grind adjustment collar to the desired setting, see figure 2.

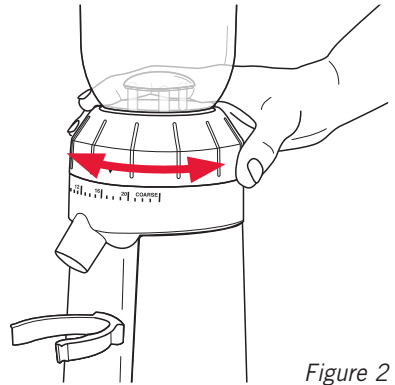

Figure 2

Refer to the grind setting table on page 9 to assist you in selecting the correct grind level for the desired brewing method.

For grinding continuous quantities

7. Remove the lid from the ground coffee container and slide onto the preparation mat. The coffee container will fit comfortably into the domestic size group handle locator, see figure 3.

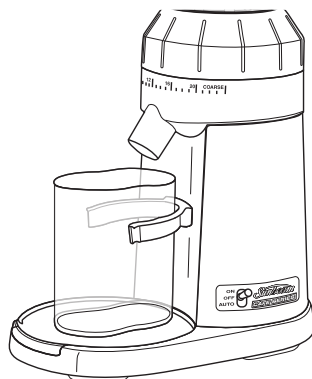
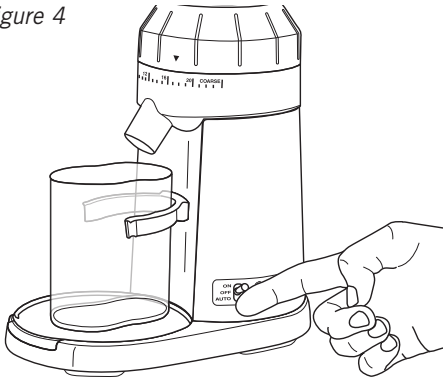

Figure 3

Operating your Café Series™ Conical Burr Coffee Grinder (continued)

8. To grind coffee, flip the switch to the 'On' position, see figure 4.

Figure 4



11. Flip the switch to the 'Auto' position, see figure 6.

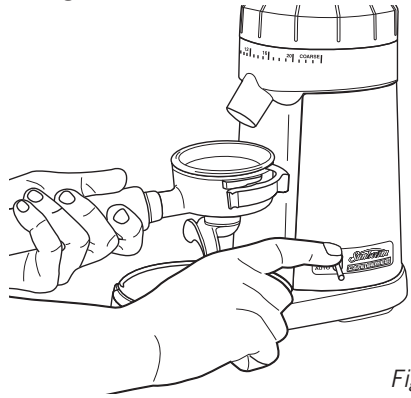

Figure 6

9. When the desired amount of coffee has been ground, flip the switch to the 'Off' position. Remove the coffee container and scoop out the ground coffee.

For grinding into the group handle

10. Position the group handle into the group handle locator, see figure 5.

Figure 5

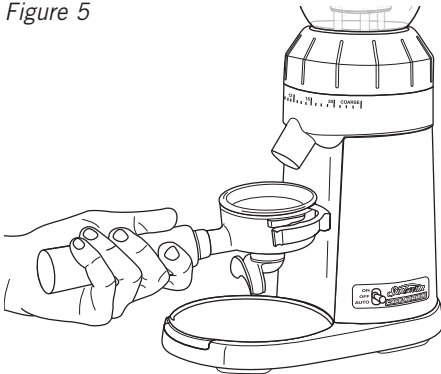

Note: There are two group handle locators provided a smaller size to fit domestic handles and a larger size for commercial handles.

12. To grind coffee, press the group handle against the button located in the centre of the group handle locator, see figure 7.

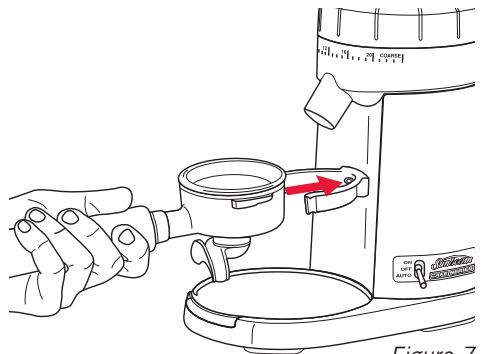

Figure 7

13. When the basket is full, pull the group handle off the button. Collapse the coffee in the basket by tapping it on the bench and repeat until the desired amount of coffee has been ground.

Note: Foreign objects like stones or twigs can sometimes be found in whole bean coffee and can cause the coffee grinder to jam. Should this occur refer to the Care and Cleaning section on page 11 as these objects need to be removed immediately.

Adjusting the Grind Setting

Grind setting table

SETTING	BREWING METHOD
2 – 6	Turkish
12 – 16	Espresso
12 – 16	Stove Top
20 – 23	Drip Filter
20 – 23	Plunger

The wide-range of 24 grind settings allows for precision adjustment. The coffee maker has complete control of the particle size and ultimately the quality of the resulting brew.

Some things to remember when using the coffee grinder;

- The smaller the particle size the longer it will take to grind.
- When using the finer settings the coffee may become stuck, we recommend tapping on the lid of the bean hopper to dislodge any clumps of coffee blocking the flow.
- After long periods of using the finer settings we recommend removing the upper burr and sweeping away any residual coffee to avoid clogging. See the Care and Cleaning section on page 11 for more details.

Tips

1. Select the correct grind for the brewing method you are using. 24 grind settings are available to ensure precision adjustment. Setting 1 produces the finest grind, 12 to 16 are medium grinds appropriate for espresso coffee makers, and 24 is the coarsest grind you can achieve. Experiment with the grind settings to achieve the ideal brew that best suits your tastes.
2. For drip filter coffee machines, a good starting point is to use 8 grams (1 scoop)

of coffee for every 4 cups of brew water as measured with the carafe. Finer grinds usually require less coffee, but using too fine a grind will result in a brew that is bitter in flavour.

3. For those that prefer weaker coffee, continue to use the recommended amount of ground coffee and then dilute the resulting brew with fresh hot water. Doing this will maximise flavour and minimise bitterness.
4. Coffee that is ground too fine for a particular brewing process will result in over-extraction and the coffee will taste bitter. On the other hand, coffee that is too coarse for a particular brewing method will result in under-extraction and the coffee will be thin and poor in flavour.
5. Once coffee is ground it quickly loses its flavour and aroma. For the best results we recommend you grind beans immediately prior to brewing.
6. Buy fresh whole coffee beans weekly.
7. To retain freshness, store whole coffee beans in an airtight container in a cool, dark, dry place. It is not recommended that you store beans in the grinder's bean hopper for a prolonged period.
8. To ensure the best results from the coffee grinder clean the bean hopper and conical burrs regularly.

Always Remember

PROBLEM	DESCRIPTION	RESULT
OVER-EXTRACTION	Over development of flavour particles (sugars etc.)	Sharp, burnt, bitter
UNDER-EXTRACTION	Under development of flavour particles	Thin, watery, weak

Care and Cleaning

Important Notes:

- Spots and marks on the surface of the burrs are part of the hardening process. These marks do not affect the performance of the grinder or the taste of the coffee.
- Ensure the coffee grinder is switched off and unplugged from the power outlet prior to cleaning.
- Do not immerse the motor base of the coffee grinder in water.
- Do not immerse any part of the burr assembly in water or any other liquid.
- Do not place any parts of the coffee grinder in the dishwasher.
- Do not use abrasive cleansers or scouring pads.

Cleaning the motor base, bean hopper and coffee container

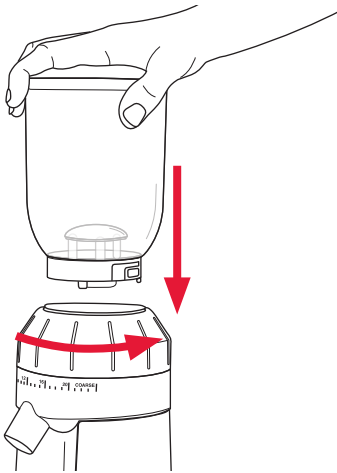

Figure 8

1. Remove the bean hopper from the motor base and store unused beans in an airtight container to preserve their freshness, see figure 8.

2. Wipe the motor base exterior with a damp cloth and dry.
3. Wash the bean hopper and coffee container in warm soapy water, then rinse and dry.

Cleaning the burrs

If the coffee grinder is used frequently (every day), the burrs need to be cleaned every three weeks to ensure best performance of the coffee grinder. Regular cleaning helps the burrs achieve consistent grinding results, which is especially important when grinding coffee for espresso.

1. Ensure the coffee grinder is switched off and unplugged from the power outlet. Remove the bean hopper from the motor base, push down and turn anti-clockwise. See figure 8.
2. To remove the top burr turn the grind adjustment collar in an anti-clockwise direction until it stops, see figure 9.

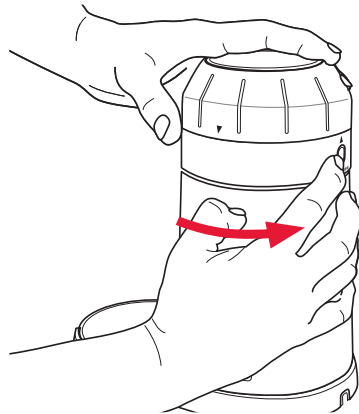

Figure 9

Note: The top burr can only be removed when the graphic arrow on the grind adjustment collar is aligned with the arrow on the motor base.

Care and Cleaning (continued)

3. Press and hold down the 'UNLOCK' button at the rear of the motor base and with the other hand turn the grind adjustment collar anti-clockwise until the graphic arrow on the collar is aligned with the arrow on the motor base, see figure 10.

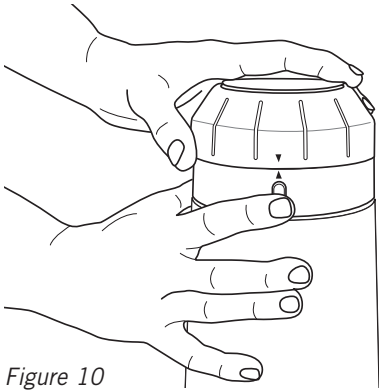

Figure 10

4. Lift out the top burr from the grind adjustment collar using the handle, see figure 11. Clean using the burr-cleaning brush.

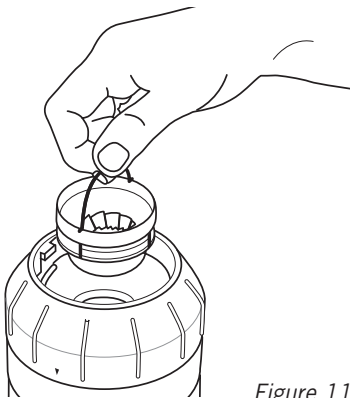

Figure 11

5. Lift the grind adjustment collar away from the motor base and clean with the brush, see figure 12.

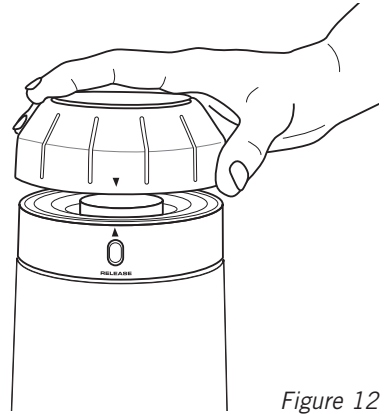

Figure 12

6. Clean the bottom burr using the burr-cleaning brush, see figure 13.

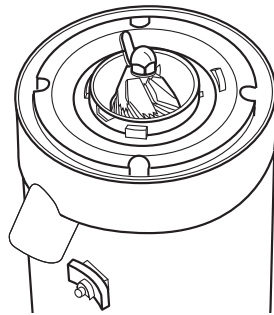

Figure 13

7. Once both burrs are cleaned, return the grind adjustment collar to its position in the motor base.
8. With the grind adjustment collar in hand align the arrow on the collar with the arrow on the rear of the motor base, press down.
9. Replace the top burr back into position in the grind adjustment collar and turn clockwise to the desired grind setting.

Care and Cleaning (continued)

Adjusting the burrs for wear

The conical burrs are made of tool hardened steel for extra long life. However after prolonged use the burrs will require adjustment to compensate for wear. A sign of this is when the grinds are not as fine as they used to be, check by rubbing some of the grinds between two fingers or for espresso the extraction will also show signs that the grind needs adjusting.

Replacing the burrs

To inquire about having the burrs replaced contact the Sunbeam Consumer Hotline on FreeCall

Australia

1800 025 059

New Zealand

0800 786 232

'Sunbeam', is a registered trademark of Sunbeam Corporation.
'Café Series' is a trademark of Sunbeam Corporation.
Made in China. Due to minor changes in design or otherwise,
the product may differ from the one shown in this leaflet.
Backed by Sunbeam's 12 Month Repair Guarantee and
National Service Network.

© Copyright. SUNBEAM CORPORATION LIMITED 2005.

(INCORPORATED IN N.S.W.) A.C.N. 000 006 771

Sunbeam Corporation is a division of GUD Holdings Ltd.

For more information or advice on this or any other
Sunbeam appliance, visit www.sunbeam.com.au or
contact the Sunbeam Consumer Service Line.

Australia 1800 025 059

New Zealand 0800 786 232.



COMMERCIAL DESIGN GUARANTEED PERFORMANCE

Consumer Hotline

Australia

1800 025 059

New Zealand

0800 786 232

www.sunbeam.com.au