

## **Installation instructions and user guide**

**Refrigerator & Freezer**

NZ AU UK IE PAC

**Active Smart™ models**

635mm wide E331T, E372B, E381T, E402B, E411T, E415H

680mm wide E406B, E413T, E440T, E442B

790mm wide E521T, E522B

**Cyclic and compact models**

525mm wide P120, E169T, C170T, C190, E240B, E249T, C270

635mm wide C373, C450, E373, E450

**Vertical freezer models**

525mm wide E150, E210

635mm wide E308, E388

**Chest freezer models**

Slimline H215, H275, H320

Standard H160, H220, H280, H360, H510, H701

<b>General operating instructions – all products</b>	
Safety and warnings	2
Installation instructions	4
Moving or storing your refrigerator	7
Door conversion	8
<b>Ice &amp; Water refrigerators</b>	
Please refer to supplement Ice & Water User Guide	
<b>Active Smart™ refrigerators</b>	
Operating instructions	9
Special features	11
Maintenance	13
Cleaning care	14
<b>Cyclic and compact refrigerators</b>	
Operating instructions	18
Special features and maintenance	19
Cleaning care	20
<b>Vertical freezers</b>	
Operating Instructions	23
<b>Chest freezers</b>	
Operating instructions	23
Special features and maintenance	24
<b>Food care – all products</b>	
Storing food in your refrigerator	25
Storing food in your freezer	27
<b>Problem solving checklist</b>	29
<b>Customer care information</b>	31

## ***Important!***

*This User Guide is to be used for all refrigerator/freezers. It contains all the general information required for the operation of your refrigerator/freezer.*

*A User Guide is provided with the Ice & Water refrigerator. This booklet contains additional specific information about the ice and water functions on the refrigerator.*

**SAVE THESE INSTRUCTIONS**

## 2 Safety and warnings

To reduce the risk of fire, electric shock, or injury to persons read the IMPORTANT SAFETY INSTRUCTIONS before operating this appliance.

Use this appliance only for its intended purpose as described in this User Guide.

### ***Important safety precautions***

#### **Warning**

*When using this appliance always exercise basic safety precautions including the following:*

#### **Danger**

- *This appliance is not intended for use by young children or infirm persons without supervision. Young children should be supervised to ensure they do not play with the appliance.*
- *Risk of child entrapment. Before you throw away your old refrigerator or freezer:*
  - *Take off the doors*
  - *Leave the shelves in place so that children may not easily climb inside.*

#### **Disposal**

- *Extreme care must be taken when disposing of your old appliance to avoid hazards. The refrigerant gas must be safely removed and for the safety of young children, remove doors.*
- *Your Fisher & Paykel Appliances Authorised Service Centre will be able to give advice on environmentally friendly methods of disposing of your old refrigerator or freezer.*

#### **Electrical**

- *Your new appliance must be properly installed in accordance with the installation instruction before it is used.*
- *Never unplug your refrigerator or freezer by pulling on the power cord.*
- *Always grip the plug firmly and pull straight out from the outlet.*
- *Do not plug in any other appliance at the same power point as your refrigerator or freezer or use extension cords or double adapters.*
- *Repair or replace immediately all electric service cords that have become frayed or otherwise damaged. Do not use a cord that shows cracks or abrasion along its length or at either the plug or appliance end.*

*If the power supply cord is damaged, it must only be replaced by your Fisher & Paykel Appliances Authorised Service Centre because special purpose tools are required.*
- *When moving your appliance away from the wall, be careful not to roll over or damage the power cord.*
- *Unplug your refrigerator or freezer before cleaning or replacing the lightbulb.*

## Storing food and drinks

- *Never store volatile or flammable materials in your refrigerator or freezer as they may explode.*
- *Never freeze liquids in glass containers. Liquid expands during freezing, which may cause the container to explode.*
- *Never freeze carbonated drinks. They may explode.*
- *Do not consume food if it is too cold. Food removed from the freezer compartment may be cold enough to cause damage when brought into contact with bare skin e.g. frozen ice cubes.*

## Power failure – food safety

- *Do not refreeze frozen foods that have thawed completely. Follow the recommendations below if you discover food in your freezer has thawed:*
  - 1) *Ice crystals still visible – food may be refrozen but should be stored for a shorter period than recommended.*
  - 2) *Thawed but refrigerator cold – refreezing generally not recommended. Fruits and some cooked food can be refrozen but use as soon as possible. Meat, fish, poultry – use immediately or cook then refreeze. Vegetables – discard as they usually go limp and soggy.*
  - 3) *Thawed but warmer than 4 °C. Red meat can be cooked immediately and refrozen but use as soon as possible. Discard all other frozen foods.*
- *Do not refreeze frozen foods that have thawed completely. The food may be dangerous to eat.*

## Cleaning

- *Many commercially available cleaning products contain solvents which may attack plastic components of your refrigerator or freezer and cause them to crack. Please refer to the cleaning care section of this booklet for further advice.*

**SAVE THESE INSTRUCTIONS**

## 4 Installation instructions

Please follow the steps for installation to ensure your appliance operates correctly.

### 1. Power

- The appliance must be installed so the plug is accessible.
- To ensure that the appliance is not accidentally switched off, connect your refrigerator or freezer to its own power point. Do not plug in any other appliance at this power point or use extension cords and double adaptors, as the combined weight of both power cords can pull the double adaptor from a wall outlet socket.
- For power requirements, refer to the information on the serial plate located at the front bottom right-hand side of the refrigerator when the door is open.
- It is essential that the appliance be properly grounded (earthed).

### 2. Location

- Your refrigerator or freezer should not be located in direct sunlight or next to any heat generating appliance such as a cooktop, oven or dishwasher.

### 3. Stability

- It is important that all four corners of the refrigerator or freezer base are supported firmly on the floor to eliminate any cabinet movement.
- Installing the appliance on a soft or uneven or unlevel floor may result in twisting of the cabinet and poor sealing of the doors. If the doors do not seal properly, warm air will enter the food storage areas causing the temperature to increase, resulting in food spoilage and food loss.
- Before moving your refrigerator or freezer into its position, ensure that the adjustable front feet are fully retracted by turning them anticlockwise, i.e. towards the right of the cabinet.
- Position your refrigerator or freezer. Turn the adjustable feet clockwise, i.e. to the left, to lower the adjustable front feet. Raise the front of the appliance until it is stable and the doors move towards the closed position, on their own, when open.
- The front levelling foot on the hinge side should take the majority of the weight of the cabinet and the cabinet should be stable, i.e. cabinet should not rock or wobble.

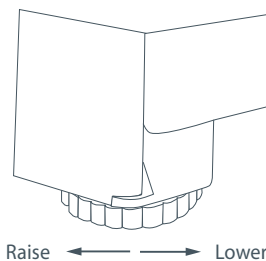

Fig.1 Refrigerator foot



### **Before placing food in the fresh food or freezer compartments**

- Remove all packaging. Ensure that all transit clips are removed from the refrigerator. These are small rubber stops located at the back of the shelves.
- Allow the refrigerator and freezer to run empty for 2 – 3 hours to allow each compartment to cool to the appropriate temperature.
- Clean the inside of the appliance with warm water and a little liquid detergent to remove manufacturing and transportation dust.
- The appliance may have an odour on its initial operation, but this will go when the refrigerator and freezer have cooled sufficiently.

### **Energy efficiency**

- Do not cover your appliances with any material that will prevent air from flowing around the cabinet sides.
- Do not leave the door open for any longer than is necessary.
- Allow good clearances in front of the air ducts within the cabinet for maximum cold air distribution.



If your refrigerator or freezer is turned off for any reason, wait 10 minutes before turning it back on. This will allow the refrigeration system pressures to equalise before restarting.

## Moving your refrigerator

- Turn off the appliance and unplug from the power point. Remove all food.
- Turn the adjustable feet to the right as far as they will turn (see page 4).
- Ease the refrigerator out of its position. Tuck the power cord away and tape the doors closed. Tape the shelves in place. If the cabinet needs to be placed at an angle or laid down, carefully lay it on its side (the right hand side when viewed from the front).
- Relocate and install. If the appliance has been left on its side for any length of time, leave it standing upright for at least 10 minutes before turning on.

## Storing your refrigerator or freezer

- When storing your cleaned appliance, leave the door(s) open. This allows air to circulate and prevents the build up of bacteria and moulds.
- Before using again, clean well using a mixture of warm water and baking soda (add 1 teaspoon of baking soda to each 500 ml of water). Rinse with clean water.

## Holiday time

We recommend you leave your refrigerator or freezer operating while you are on holiday.

If you need to hinge your door on the opposite side we recommend that you call your local Fisher and Paykel Authorised Service Centre or Dealer to make this conversion.

*Active Smart™* refrigerator models with silver handles need to be ordered at the point of purchase either with left or right opening doors and can not be interchanged.

All other models need to have an appropriate conversion kit for that model refrigerator.

The kit is available from your Authorised Service Centre or Dealer. Full instructions are included in the conversion kit.

<b>Models:</b>	635mm wide	E331T, E372B, E381T, E402B, E411T, E415H
	680mm wide	E406B, E413T, E440T, E442B
	790mm wide	E521T, E522B

For information on the operation of the Ice & Water control panel please refer to the Ice & Water User Guide.

## Temperature control

- When the refrigerator is first turned on, the powerful cooling system will automatically cool both refrigerator and freezer compartments to their set temperatures. This will take between 2 – 3 hours depending on the temperature and humidity of the environment.
- The two compartment temperatures are accurately and independently controlled and do not change with the temperature or humidity of the surroundings; whether summer or winter.
- If you wish to alter the temperature of either the fresh food compartment or freezer compartment, this can be easily done by using the control panel located at the back of the fresh food compartment.

## Control panel to adjust temperatures

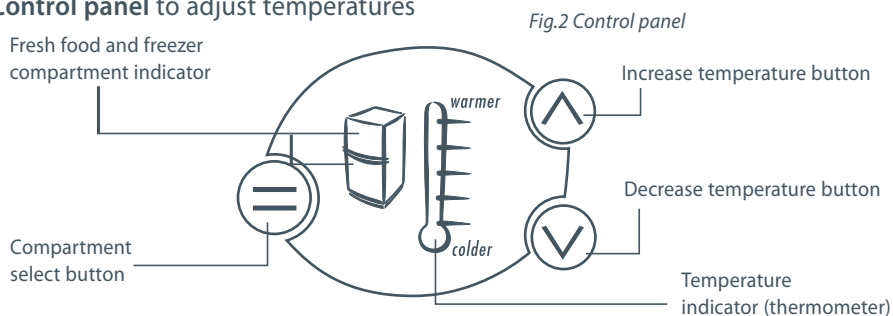

## Fresh food compartment

- The fresh food compartment light on the refrigerator diagram will be showing. The temperature indicator illustrated by a thermometer will show the temperature setting for this compartment as a series of lights.
- The temperature may be altered by pressing the increase temperature or decrease temperature buttons. One press on either of these buttons will produce a dimmer light which indicates a small change in temperature.
- Pressing either button twice gives a brighter light and indicates a greater change in temperature. Fewer lights on the thermometer means a cooler temperature for the compartment selected.

## Freezer food compartment

- To adjust the freezer temperature press the compartment select button until the light flashes on the freezer compartment indicator.
- The freezer temperature can be altered by pressing the increase or decrease temperature buttons.
- One press on either of these buttons will produce a dimmer light which indicates a small change in temperature. Pressing either button twice gives a brighter light and indicates a greater change in temperature.

Note: Successively pressing the compartment select button will automatically scroll between the compartments, a return to the fresh food compartment will be accompanied by a longer beep.

- When the door is reopened the control panel will return automatically to the fresh food compartment setting.

## Sabbath mode

- To activate the Sabbath mode press the compartment select button on the temperature control panel for 10 seconds.

### **When the product is in sabbath mode:**

- The light will not operate when the door is opened.
- The door alarm will not operate.
- The display will not be illuminated.
- Opening the door will not affect the compressor or fans.
- If the power to the refrigerator is turned off whilst in this mode, the product will continue in Sabbath mode when the power is restored.
- Sabbath mode will automatically de-activate 80 hours after activation.
- To de-activate earlier than 80 hours press the compartment select button on the temperature control panel for 10 seconds.

## Normal refrigerator sounds

*Active Smart™* refrigerators, with their excellent energy ratings and cooling performance, can produce sounds somewhat different to your old refrigerator.

### **Normal operational sounds include:**

- Fan air flow sound. *Active Smart™* refrigerators have fans which change speed depending on demand. During cooling periods, such as after frequent door openings, fans circulate the cold air in the refrigerator and freezer compartments producing some air flow sound. This is quite normal.
- Cracking or popping which may sound like ice coming off the evaporator. This occurs when the defrost function is operating.
- Running water sound. This is the liquid refrigerant in the system and can be heard as a boiling or gurgling noise.
- An audible hissing sound after closing the freezer door. This is due to the pressure difference between the warm air that has entered the cabinet and suddenly cooled, and the outside air pressure.
- Other strange sounds may be heard for the following reasons:
  - Cabinet not level
  - Floor uneven or weak
  - Bottles or jars rattling on shelves

### Fruit and vegetable bins and humidity control cover

The fruit and vegetable bins feature a unique cover which provides two functions:

- The humidity cover seals the bins and provides a humid microclimate to extend storage times of fruits and vegetables.
- The humidity cover prevents condensation, which forms at high humidities, from dripping down onto the fruit and vegetables. The ability to retain high humidity in the fruit and vegetable bin may produce small amounts of water in the bottom of the fruit and vegetable bins. This can be wiped out as required.

### Fruit and vegetable bins and humidity slide (where fitted)

- Each fruit and vegetable bin has a humidity adaptor control that can be adjusted to fruit or vegetables depending on what is stored in the bins.
- If possible try to store fruit and vegetables separately. This will help extend their storage life.
- If there is a mixture of fruit and vegetables in the bin adjust the position of the control to the centre.
- If there is too much water in the bins the control can be adjusted towards the setting with fewer drips.
- Remember a small amount of water in the bins is beneficial for fruit and vegetable storage.

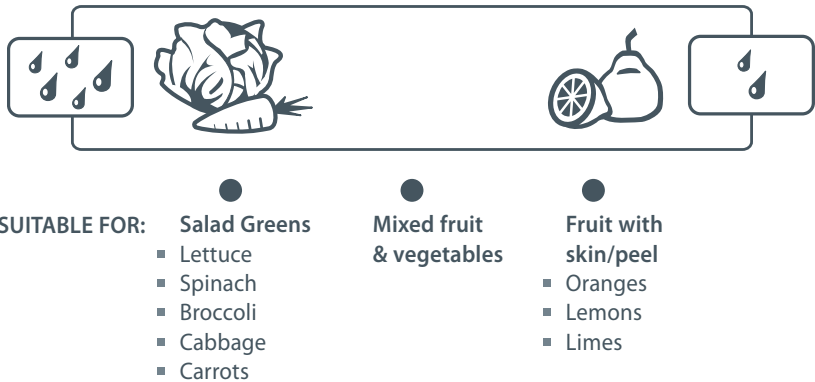

Fig.3 Humidity Control graphic

### Ice trays and lid

- To empty the ice cubes into the lid, hold the tray and lid together and twist to dislodge.
- Refill the ice tray with water, place lid containing ice cubes on top and store in the freezer.
- Ice cubes are best stored in a closed container or plastic bag as they readily absorb odours and tastes from other foods.

### Deodoriser (Where fitted)

- A deodoriser is fitted to remove unpleasant odours from the refrigerator. It is located behind the duct cover in the fresh food compartment and will last for the life of your fridge.

### Door alarms

- If the fresh food compartment door is left open the alarm will beep after 90 seconds and if the freezer door is left open the alarm will beep after 60 seconds.
- While either door remains open, subsequent beeps will sound every 30 seconds for 5 minutes.
- A continuous alarm will sound if the door has been left open for 5 minutes or longer and the light will turn off. The alarm will stop when the door is closed.

### Fault alarms

- If the electronic controller detects a fault from which it is unable to recover an alarm will sound.
- When the fresh food compartment door is opened a fault code (specific pattern of lights) will flash red and green on the Control panel to alert you to the fault. The audible alarm will stop when any button is pressed but the lights will remain flashing. If such a fault occurs, call your Fisher & Paykel Appliances Authorised Service Centre immediately; the fault code will help the service person find and remedy the cause of failure.

### Divider instructions (Where fitted)

To fit the divider, insert divider into bin on an angle, straighten and slot into place. To adjust the divider, fully extend the bin, partially lift the divider, slide sideways and re-slot into position.

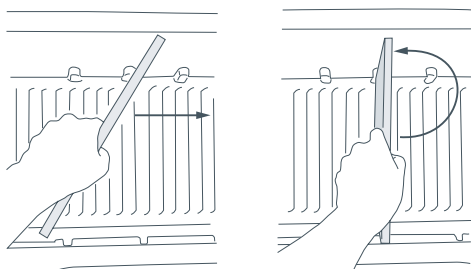

Fig.4 Vegetable bin divider

### Roll out drawer model E415H

- The roll out drawer is suitable for storing fruits and vegetables as well as tall bottles and drinks.
- A vent/baffle is located at the front of the drawer.
- The temperature in the drawer can be adjusted by opening or closing this vent.
- Opening the vent fully allows more cold air into the drawer. Typical operating temperatures in this compartment are from 3°C to 9°C.
- The closed vent situation is ideal for storage of tomatoes, tropical fruit, cucumber, capsicum etc. as these foods do not keep as well at colder temperatures.
- The open vent situation is suitable for most vegetables and fruits. Uncut fruit and vegetables with protective skin (e.g. apples and pears) can be stored without wrapping.
- To extend the storage life of other fruit and vegetables place them in loosely sealed plastic bags. This will reduce moisture loss and prevent excess moisture build-up.

### Bottle rack (Where fitted)

- The bottle rack can be used to store a variety of bottles and can be positioned anywhere you would a shelf. To re-position, lift the rear of the rack and pull forward. Bottles are best stored with the top facing the front of the refrigerator.

## Replacement of the interior light (Halogen light bulb)

Turn the power off at the wall socket before replacing the bulb. The light bulb is located on the top roof of the cabinet at the front.

- Remove the lens cover using a small screwdriver. Insert the screwdriver in the front centre of the lens cover and gently lever down. Pull out old bulb.
- Do not touch the new bulb with your hand. Leave it in the plastic bag whilst slotting into position.
- Remove plastic bag when bulb is in position.
- Replace lens cover.
- Turn power on. Light bulb should now glow.

Note: The replacement halogen bulb must not exceed 12 Volt/10 Watt. Bulbs are available from your Fisher & Paykel Appliances Customer Care Centre.

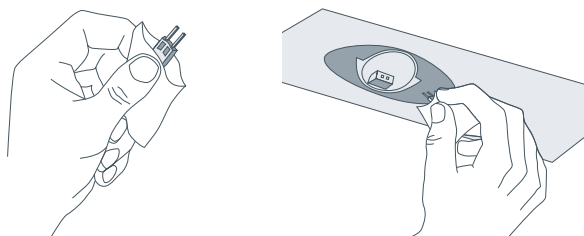

Fig.5 Halogen light replacement

### ***Important!***

*Your refrigerator is designed to operate for many years without the need for service checks. However, if your refrigerator is malfunctioning, have it attended to by your Fisher & Paykel Appliances Authorised Service Centre as soon as possible. All electrical repairs must be carried out by an adequately trained service technician or qualified electrician.*

## **Interior**

- It is important to keep the interior of the refrigerator and freezer clean to help prevent food from becoming contaminated during storage.
- The amount and types of food stored determines how often cleaning should be carried out (ideally once every 1 to 2 weeks) in the refrigerator.
- Remove the shelves from cabinet and door. Wash shelves and storage bins in warm water and detergent; rinse in clean water and dry before replacing.
- Wipe over the interior surfaces with warm water and detergent or baking soda dissolved in warm water (add 1 teaspoon of baking soda to each 500mls of water). Rinse with clean water.
- To help remove “old stale refrigerator” smells add a few drops of vanilla essence or vinegar to the water before cleaning.
- Clean exterior surfaces with warm water and detergent. Use a toothbrush for the magnetic door gasket.
- Do not use harsh, abrasive cloths or cleaners or highly perfumed, strong smelling cleaners or solvents on any part of the refrigerator or freezer.

## **Exterior**

### **Stainless exterior door**

- It is important when cleaning the exterior door surface of your refrigerator, to only use liquid dishwashing detergent dissolved in warm water.
- Dry the door with a clean, lint free cloth.
- The use of any abrasive or stainless steel cleaners and solvents will damage the door surface.

### **Other exterior surfaces**

- Clean all other exterior surfaces with warm water and detergent.
- If necessary, clean the magnetic door gasket with an old toothbrush, warm water and detergent.

### **Water evaporator tray**

- The water evaporator tray is found above the compressor at the back of the refrigerator or freezer. The tray may require infrequent cleaning.
- Carefully move the refrigerator or freezer out from the wall.
- Switch off the appliance.
- If the tray is full, have one person support the tray while another person unscrews the fasteners. Take care not to spill any liquid over the electrical components. Empty trays may have the fasteners loosened and the tray slipped over through the keyhole. (Reverse order to reassemble).
- Wipe out with warm water and detergent or disinfectant.
- Reassemble taking care not to over-tighten the fasteners.
- Switch on the appliance.



## Interior

### Glass shelves

Clean with warm water and detergent or a glass cleaner. If cleaning the shelves without removing from the cabinet, use only warm water and detergent as a glass cleaner can damage the plastic components of your refrigerator.

### **Important!**

*Many commercially available cleaning products contain solvents that may attack the plastic components of your freezer and cause them to crack. It is important to use only warm water and a small amount of liquid dishwashing detergent on any plastic components inside and outside your freezer. Avoid using anti-bacterial cleaning products on either the interior or exterior of the cabinet as they may cause rusting of metal components and cracking of plastic components.*

### Bottle rack (where fitted)

- Clean with warm water and detergent. The use of abrasive cleaners and solvents may cause damage.

### To remove trays or fixed bins

- For ease of removal, empty food from tray/bin first.
- Hold the centre front of the tray/bin handle.
- Lift vertically to unclip from the runners and pull tray/bin towards you to remove.
- Push runners back into refrigerator.

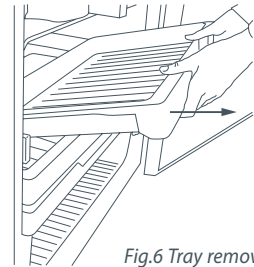
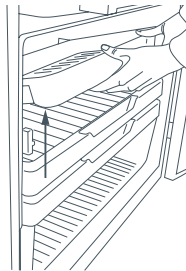

Fig.6 Tray removal

### To replace trays or fixed bins:

- With the runners pushed back into the refrigerator, place the tray/bin on top of the runners. Push the tray/bin back slowly until you feel it clip back onto the runners.

### **Important!**

*Ensure that trays and bins are securely clipped onto the runners before use.*

*Bin and tray runners are pre-lubricated, and will not need to be re-lubricated during their life. Do not attempt to clean grease from the runners, as this will affect their ability to function. Do not immerse runners in water.*

## Humidity Control System (where fitted)

### **Important!**

*When cleaning the shelf above the vegetable bins, we recommend that you do not disassemble the Humidity Control System from the shelf.*

In the event that the plastic lid and humidity slides become separated from the glass shelf, follow these instructions to reassemble.

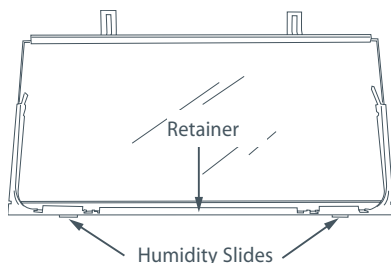

- 1 Turn shelf upside down
- 2 To attach humidity slides onto shelf front corners, fit bottom clips into shelf front trim. Next, slide sideways towards shelf until arm clips onto glass.

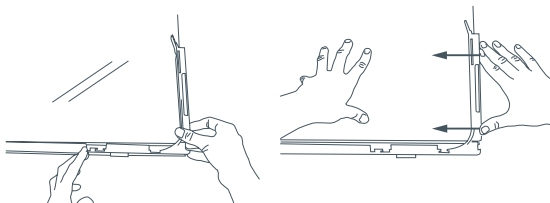

- 3 To attach humidity control lid – with text facing you, align lid with front of shelf. Hold lid vertically and fit front end into retainer on shelf. Ensure lid fits into retainer as well as underneath humidity slides.

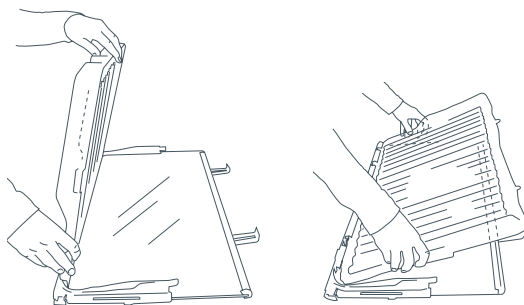

- 4 At the sides of the shelf, adjust humidity slide tabs so that the plastic lid is between the shelf and the tabs.
- 5 If clips on back of shelf are present, fasten lid with rear clips. Ensure that the cover is fully secure at front and back of shelf.

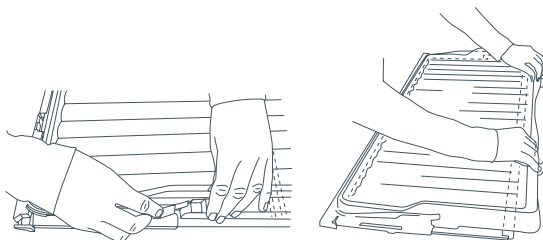

Fig.7 Humidity Control System cleaning

## Roll out fruit and vegetable bin – E415H

- Remove for cleaning by pulling out the compartment until it stops, lifting and then continuing to slide it forward until it is fully extended.
- Rest the door front on the floor and with the refrigerator compartment door open, remove the tray, divider rack and bin. Wash with warm water and detergent.
- Rinse, dry and replace.

## Lower shelf in models with roll out Fruit and vegetable bin – E415H

- Remove the front baffle after lifting its inner edge. With the refrigerator compartment door open, slide the shelf forward and lift out. Clean with warm water and detergent.
- Rinse, dry and replace in the second groove up from the side runner rail.

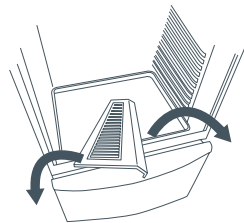

Fig.8 Front baffle

<b>Models:</b>	<b>525mm wide</b>	<b>P120, E169T, C170T, C190, E240B, E249T, C270</b>
		<b>(Compact Models)</b>
	<b>635mm wide</b>	<b>C373, E373, C450, E450</b>

## Temperature control

- The control has been factory set for normal operating conditions.
- Allow the refrigerator to run empty for 2 – 3 hours before placing food inside the fresh food or freezer compartments.
- Re-adjust the control as necessary to suit your individual preference.

1 is warmest setting

7 is coldest setting

- We recommend adjusting the temperature by half a setting initially and then allow at least 24 hours for the cabinet temperature to stabilise before readjusting.
- If you are altering the temperature of a 2-door refrigerator, remember you are altering the temperature of both compartments.
- The running time and temperature are affected by where your refrigerator is located, how often the door is opened and the temperature of the room the refrigerator is located in. Your refrigerator is designed to operate in a room temperature of between 10°C and 43°C.

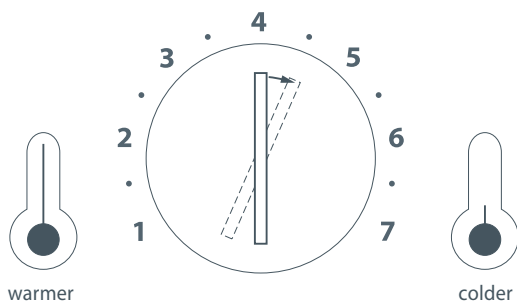

Fig.9 Temperature knob

## P120 Ice box

This is designed for short-term storage of frozen foods and ice only. It is recommended that the tray is kept in place under the ice box at all times.

## Door alarms (E169T, E240B, E249T, E373, E450 only)

- If the fresh food compartment door is left open the alarm will beep after 90 seconds.
- If the door remains open, subsequent beeps will sound every 30 seconds for 5 minutes.
- A continuous alarm will sound if the door has been left open for 5 minutes or longer.
- The alarm will stop when the door is closed.

## Fault alarms

- If the electronic controller detects a fault from which it is unable to recover, an alarm will sound when the door is opened.
- When the fresh food compartment door is opened and a fault has occurred, a specific number of beeps will sound. If a fault occurs, call your Fisher & Paykel Authorised Service Centre immediately; the number of beeps will help the service person find and remedy the cause of failure.

## Humidity control cover (635mm wide models)

The vegetable bins feature a unique cover which provides two functions:

- The humidity control cover seals the bins to provide a humid microclimate to extend storage times.
- The humidity control cover prevents condensation which forms at high humidities from dripping down onto the fruit and vegetables.

The ability to retain high humidity in the fruit and vegetable bin may produce small amounts of water in the bottom of the fruit and vegetable bin. This can be wiped out as required.

## Replacement of interior light

- Turn the power off at the wall before replacing the lamp. The interior lamp is located at the back of the temperature control box and is removed by unscrewing it.
- Replace bulb, making sure it is tightly screwed in. Switch power back on again.
- The replacement bulb must not exceed 15 Watts. Bulbs are available from your Fisher & Paykel Authorised Service Centre.

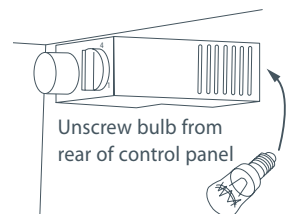

Fig.10 Temperature control box

## Important!

*Your refrigerator is designed to operate for many years without the need for frequent service checks. However, if your refrigerator is malfunctioning, have it attended to by your Fisher & Paykel Authorised Service Centre as soon as possible.*

*All electrical repairs must be carried out by an adequately trained service technician or qualified electrician.*

## Interior

- It is important to keep the interior of the refrigerator and freezer clean to help prevent food from becoming contaminated during storage.
- The amount and types of food stored determines how often cleaning should be carried out (ideally once every 1 to 2 weeks) in the refrigerator.
- Remove the shelves from cabinet and door. Wash shelves and storage bins in warm water and detergent; rinse in clean water and dry before replacing.
- Wipe over the interior surfaces with warm water and detergent or baking soda dissolved in warm water (add 1 teaspoon of baking soda to each 500mls of water). Rinse with clean water.
- To help remove “old stale refrigerator” smells add a few drops of vanilla essence or vinegar to the water before cleaning.
- Clean exterior surfaces with warm water and detergent. Use a toothbrush for the magnetic door gasket.
- Do not use harsh, abrasive cloths or cleaners or highly perfumed, strong smelling cleaners or solvents on any part of the refrigerator or freezer.

## Glass shelves

- Clean with warm water and detergent or a glass cleaner. If cleaning the shelves without removing from the cabinet use only warm water and detergent as a glass cleaner can damage the plastic components of your refrigerator.

## Exterior

### Stainless exterior door

- It is important when cleaning the exterior door surface of your refrigerator, to only use liquid dishwashing detergent dissolved in warm water.
- Dry the door with a clean, lint free cloth.
- The use of any abrasive or stainless steel cleaners and solvents will damage the door surface.

### Other exterior surfaces

- Clean all other exterior surfaces with warm water and detergent.
- If necessary, clean the magnetic door gasket with an old toothbrush, warm water and detergent.

### Water evaporator tray

- The water evaporator tray is found above the compressor at the back of the refrigerator or freezer. The tray may require infrequent cleaning.
- Carefully move the refrigerator or freezer out from the wall. Switch off the appliance.
- If the tray is full, have one person support the tray while another person unscrews the fasteners. Take care not to spill any liquid over the electrical components. Empty trays may have the fasteners loosened and the tray slipped over through the keyhole. (Reverse order to reassemble).
- Wipe out with warm water and detergent or disinfectant.
- Reassemble taking care not to over-tighten the fasteners. Switch on the appliance.

## Vegetable bin – 525mm wide models – except P120 models

- Wash in warm water and detergent. Rinse and dry.

## Fruit and vegetable bins and cover – 635mm wide models

- Remove bins then the bottom refrigerator shelf.
- Place the shelf upside down on a flat surface. Pull cover at position A then lift up at position B. Take cover off at sides. Clean cover and bins in warm soapy water.
- To reassemble, insert cover and clip at position C, then snap in the clip at position A.

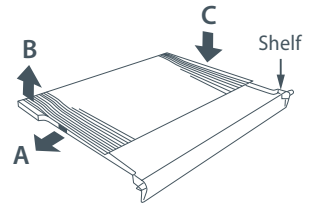

*Fig.11 Humidity Control cover*

## Defrosting the freezer model C170T

- It is recommended that a freezer be defrosted when the frost is greater than 6mm thick.
- Remove all frozen food and wrap it in several layers of paper. Place food in the refrigerator compartment or a cool environment e.g. insulated picnic bin.
- Switch the power off at the wall. The temperature control can remain at its normal setting.
- Remove the freezer baskets or shelves for ease of cleaning.
- Whilst defrosting, leave the freezer door open. If you wish to reduce the defrosting time place a bowl of warm water in the freezer compartment and leave the door open. Keep the refrigerator compartment door closed.
- Use the scraper supplied or a plastic spatula to remove any loose ice. Do not use knives or any other sharp instrument to remove the ice, otherwise the freezer surface may become permanently damaged.
- Ensure that the defrosting of your freezer is carried out as quickly as possible. During defrosting a rise in temperature of frozen food above normal storage temperature can shorten the storage time of the food.
- Wipe the freezer dry. Replace the frozen food.
- Switch the refrigerator on.

## Defrosting models with ice boxes

The P120 is designed for short-term storage of frozen foods and ice only.

- Remove all frozen food and wrap it in several layers of paper. Place in a cool environment e.g. insulated picnic bin.
- Position the tray provided beneath the icebox to collect the melting ice.
- Push the defrost button in the centre of the control knob and the compressor will stop. The defrost time may be reduced by placing a bowl of warm water in the icebox and leaving the door of the refrigerator open. Once it has reached the defrost temperature, the compressor will start operating again.
- Use the scraper supplied or a plastic spatula to remove any loose ice.
- Immediately after the refrigerator has automatically restarted, empty the tray of water and ice.
- Wipe the tray and icebox dry.
- Replace the frozen food.



**Models:**      525mm wide      E150, E210  
                   635mm wide      E308, E388

## Temperature control

- The cabinet control is located at the bottom rear of the cabinet.
- The control has been factory set to position 4 for normal operating conditions.
- The freezer temperature should be approximately  $-18^{\circ}\text{C}$ .
- Re-adjust the control as necessary to suit your individual preference.

1 is the warmest setting.  
 7 is the coldest setting.

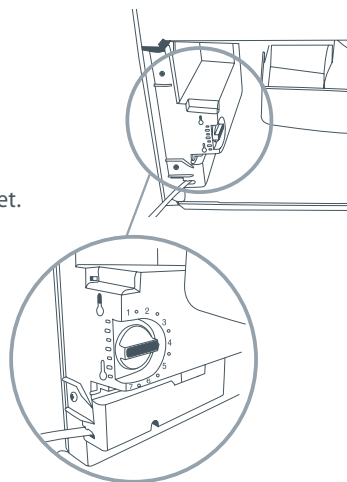

Fig.12 Control box

## Door alarms

- If the door is left open the alarm will beep after 60 seconds.
- If the door remains open, subsequent beeps will sound every 30 seconds for 5 minutes.
- A continuous alarm will sound if the door has been left open for 5 minutes or longer.
- The alarm will stop when the door is closed.

## Fault alarms

- If the electronic controller detects a fault from which it is unable to recover, an alarm will sound when the door is opened.
- When the door is opened and a fault has occurred, a specific number of beeps will sound. If a fault occurs, call your Fisher & Paykel Authorised Service Centre immediately; the number of beeps will help the service person find and remedy the cause of failure.

# Chest freezer operating instructions

## Temperature control

- The temperature of the freezer is controlled by a thermostat fitted near the right hand rear corner of the freezer.
- The thermostat has been set to position 4 at manufacturing for normal operating conditions and should not need adjustment. The freezer compartment should be approximately  $-18^{\circ}\text{C}$ . At this temperature the food will keep for the length specified on the freezer storage guide.
- Re-adjust the control as necessary to suit your individual preference.

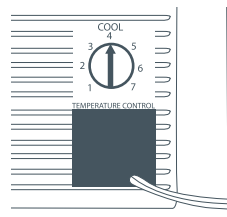

Fig.13 Temperature control

1 is the warmest setting.  
 7 is the coldest setting.

### Defrosting your chest freezer

- It is recommended that your freezer be defrosted when the frost is greater than 6 to 10mm thick using the plastic scraper provided.
- Remove all frozen food and wrap it in several layers of paper. Place in a refrigerator compartment or a cool environment e.g insulated bin.
- Switch the power off at the wall.
- Unplug and open the defrost water drain and spout. Place a shallow container under the spout. Pour approximately 1 litre of warm water down the drain to clear it of possible residual ice. Should it remain blocked, the spout can be removed to aid thorough cleaning.
- While defrosting, leave the freezer lid open. If you wish to reduce the defrosting time, place containers of hot water in the freezer and close the lid. Use the scraper supplied and a plastic spatula to remove any loose ice.
- Empty out the tray of water. Wipe out the defrosted freezer. Use a mix of 500ml water with 1 teaspoon of baking soda or a small amount of liquid dishwashing detergent and warm water. Rinse with clean water and dry.
- Carefully clean the drain and spout. Replace the drain plug and then close the spout.
- Switch the freezer on. Close the lid and leave running for 15 minutes before replacing the frozen food.
- Do not use knives or any other sharp instrument to remove the ice as the freezer surface may become irreversibly damaged.
- Also do not use harsh abrasive cloths and cleaners, or highly perfumed strong smelling cleaners or solvents on either the interior or exterior of the freezer.
- Frost forms faster on the top edge of the freezer compartment in climates of high humidity as this is the area of first contact to the warm moist air when the lid is open.
- Your chest freezer is designed with a flexible lid seal to keep warm air out of the freezer. Sometimes immediately after closing your chest freezer, you may notice the lid is difficult to re-open. This is normal. Wait a few minutes and try again.

### Freezer baskets

- The baskets supplied with your freezer are removable.
- They may be stacked on top of each other by folding the handles downwards. Ensure that packages do not protrude above the top of each basket, and for ease of lifting make sure they are not loaded with a lot of heavy food.
- We recommend that foods requiring longer storage should be kept at the bottom of the freezer.

### Replacement of interior light

- When it is necessary to replace the light bulb, turn the freezer off at the wall, remove the light cover and unscrew the bulb. Replace with a new bulb, noting that it must not exceed 15 Watts.

### **Important!**

*Your refrigerator is designed to operate for many years without the need for frequent service checks. However, if your refrigerator is malfunctioning, have it attended to by your Fisher & Paykel Authorised Service Centre as soon as possible.*

*All electrical repairs must be carried out by an adequately trained service technician or qualified electrician.*

Storing fresh, perishable foods in your refrigerator helps to extend storage times. The cold temperatures slow down the major causes of food spoilage – namely, the growth of bacteria, moulds and yeasts, and chemical and physical reactions.

## Fresh food care

The quality of food before it is placed in the refrigerator is critical to successful storage. For best results:

- Select foods that are very fresh and of good quality.
- Buy only the amount that you will use within the recommended storage time. If you buy extra, plan to freeze it.
- Ensure that food is well wrapped or covered before it is stored. This will prevent food from dehydrating, deteriorating in colour or losing taste and will help maintain freshness. It will also prevent odour transfer. Vegetables and fruit need not be wrapped provided they are stored in the vegetable bins of the refrigerator.
- Make sure that strong smelling foods are wrapped or covered and stored away from foods such as butter, milk and cream which can be tainted by strong odours.
- Refrigerate fresh, perishable foods as soon as possible after purchase. If left at room temperature for any length of time the rate of deterioration will be accelerated.
- Avoid placing food directly in front of air outlets, as it may freeze. Cold air needs to circulate to maintain safe food storage. Do not open the refrigerator door unnecessarily.
- Cool hot foods down before placing them in the refrigerator. This should be done quickly. It can be aided by placing the container of food in a bowl of ice and water; renew the ice as necessary. (Note also that hot containers may damage shelves and wall of the refrigerator).
- Store raw and cooked food in separate containers or packaging to prevent cross contamination.

### In addition:

- Keep the refrigerator clean. Wipe the inside walls and shelves frequently (refer to Cleaning Care) and place only clean containers in the refrigerator.
- Keep a close check on the quality of food in your refrigerator. Discard any food that shows signs of spoilage. Pay particular attention to meat, fish and poultry, as these foods are highly perishable. Use food within the recommended storage times.

## Dairy foods and eggs

- Most pre-packed dairy foods have a recommended use by/best before/best by' date stamped on them. Store them in the refrigerator and use within the recommended time.
- Butter can become tainted by strong smelling foods so it is best stored in a sealed container.
- Eggs should be stored in the refrigerator. For best results, especially when baking, remove the eggs from the refrigerator two hours before they are to be used.



### Red Meat

- Place fresh red meat on a plate and loosely cover with waxed paper or plastic wrap or foil.
- Store cooked and raw meat on separate plates. This will prevent any juices lost from the raw meat from contaminating the cooked product.
- Delicatessen meats should be used within the recommended storage time.



### Poultry

- Fresh whole birds should be rinsed inside and out with cold running water. Dry and place on a plate. Cover loosely with plastic wrap or foil.
- Poultry pieces should also be stored this way. Whole poultry should never be stuffed until just before cooking, otherwise food poisoning may result.
- Cool and refrigerate cooked poultry quickly. Remove stuffing from poultry and store separately.



### Fish and seafood

- Whole fish and fillets should be used on the day of purchase. Until required, refrigerate on a plate loosely covered with plastic wrap, waxed paper or foil.
- If storing overnight or longer, take particular care to select very fresh fish. Whole fish should be rinsed in cold water to remove loose scales and dirt and then patted dry with paper towels. Place whole fish or fillets in a sealed plastic bag.
- Keep shellfish chilled at all times. Use within 1 – 2 days.

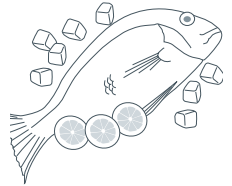

### Precooked foods and leftovers

- These should be stored in suitable covered containers so that the food will not dry out.
- Keep for only 1 – 2 days.
- Reheat leftovers only once and until steaming hot.

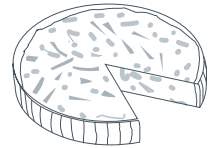

### Fruit and vegetable bins

- Although most fruit and vegetable varieties store best at low temperatures, take care not to store the following at temperatures of less than 7°C for long periods.
  - Citrus fruit
  - Melons
  - Eggplant
  - Pineapple
  - Paw Paw
  - Courgettes
  - Passionfruit
  - Cucumber
  - Peppers
  - Tomatoes
- Undesirable changes will occur at low temperatures such as softening of the flesh, browning and/or accelerated decaying.
- Do not refrigerate avocados (until they are ripe), bananas, mangoes or pepinos. If possible store fruit and vegetables separately, i.e. fruit in one bin and vegetables in the other.

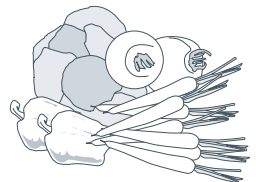

The use of temperatures of -18°C or colder to store food means that the food can be kept for longer periods than when refrigeration temperatures are used. This is because the growth of bacteria, moulds and yeasts are stopped, and chemical and physical reactions are severely restricted at very low temperatures.

## Frozen food care

For best results:

- Choose only high quality foods that freeze well.
- Store at -18°C or colder. Take care to maintain this low storage temperature e.g. try to avoid opening the freezer door unnecessarily. If your ice cream is soft you are running your freezer too warm.
- Leave space at the top of containers, glass jars or plastic bags containing liquids or semi-solid foods. These expand as they freeze. Usually 20 – 50mm head space is recommended. Seal. Ideally, remove all the air from the package after food is frozen.
- Packages or containers of solid foods should have the air removed from them and be sealed tightly before freezing.
- Freeze immediately and as quickly as possible. Freeze only small quantities of food at any one time. For best results we recommend that only 1kg of food be frozen per 25L freezer capacity. (About 3 kg in small freezers and 4kg in larger freezers). For faster freezing in *Active Smart™* models, we recommend that fresh food is placed at the top of the freezer compartment close to the air vent.
- Do not pile frozen food around the fan cover. It can prevent adequate air circulation.
- Thaw foods preferably in a refrigerator, or using a microwave oven or multifunction oven.
- Keep a constant turnover of food. Use older items of food first. Do not exceed recommended storage times.
- Use good quality freezer proof packaging to maintain food quality.
- If food is only covered in plastic film place inside a freezer-proof plastic bag.

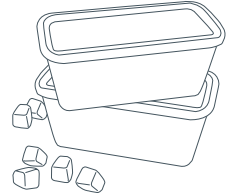

## Recommended freezer storage times

These times should not be exceeded.

	<b>M o n t h s</b>	1	Bacon, casseroles, milk
		2	Bread, ice-cream, sausages, pies – (meat and fruit), prepared shellfish, oily fish
		3	Non oily fish, shellfish, pizza, scones and muffins
		4	Ham, cakes, biscuits, beef and lamb chops, poultry pieces
		6	Butter, vegetables (blanched), eggs whole and yolks, cooked crayfish, minced meat (raw), pork (raw)
		12	Fruit (dry or in syrup), egg whites, beef (raw), whole chicken, lamb (raw), fruit cakes

## Meat, Poultry and Game

- Do not try to freeze more than 1kg meat per 25L freezer capacity. Meat must be frozen quickly in order to maintain its texture.
- Do not stuff poultry before freezing.
- Red meat can be cooked from frozen, or from the partly or completely thawed states. Remember to allow extra cooking time if cooking from frozen.
- Always thaw poultry completely before cooking.



## Fish

- Fish is best frozen commercially. If however you do want to freeze fish at home, make sure the fish is very fresh and of high quality.
- Clean, scale and preferably leave whole. All fish should be wrapped in two layers of packaging as depending on the type of fish, odours and flavours can be readily transferred either to or from it. Seal well.
- For best results, cook from either the frozen or partly thawed state.

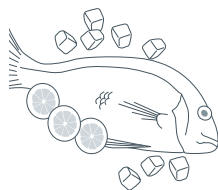

## Vegetables

- Most vegetables freeze well, although 'salad' vegetables lose their crispness. Other vegetables e.g. celery, onion and tomatoes should only be used in cooked dishes as they soften on freezing.
- Freeze only high quality, mature, ready-to-eat vegetables.
- Sort and discard any that are damaged.
- **It is necessary to blanch most raw vegetables prior to freezing.**
- Blanching involves a short cooking period during which vegetable enzymes are destroyed. If these enzymes are not destroyed they cause undesirable physical and chemical changes during freezer storage.
- Vegetables can be blanched in boiling water, steam or microwave oven. If using boiling water, boil vegetables for 2 – 4 minutes and cool quickly.
- In general frozen vegetables are best cooked from their frozen state.

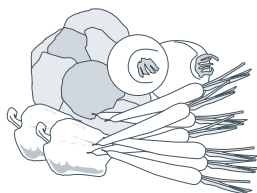

## Prepared and cooked foods

- Most cooked foods can be frozen but it is not recommended to freeze the following:
- Cooked egg white, custards, cream fillings and milk puddings, gelatine or jelly-like dishes, mayonnaise and similar salad dressings, meringue toppings. These tend to separate on thawing.

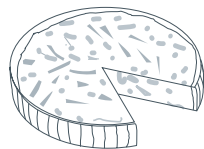

## Fruit

- Choose high quality, mature, and ready to eat fruit. Preferably select varieties recommended for freezing.
- Avoid unripe and over-ripe fruit.
- The way fruit is packed depends on how it is to be used. Fruits packed in syrup are ideal for desserts, whereas fruits packed without sugar are better used for cooking. Most fruits can be stored for 8 – 12 months.



If there is a problem with your appliance, please check the following points before contacting your local Fisher & Paykel Appliances Authorised Service Centre Dealer or Customer Care Centre.

Problem	Possible causes	What to do
<b>Appliance does not operate</b>	No electricity at power outlet	Check that the plug is correctly connected and power switched on Check another appliance at the same outlet Check house fuse
<b>Light not working</b>	Blown light bulb	Change light bulb
	Refrigerator not working	See Maintenance section
<b>Light and display not working</b>	Product in Sabbath Mode	Hold compartment select button down for 10 seconds
<b>Motor operates for long periods</b>	Hot weather Frequent door lid openings Large amount of food recently added	Minimise door opening to allow temperature to stabilise
	Temperature control set too low	See Temperature control section
	Doors not sealing properly	Check that cabinet is level and gasket seals are clean
<b>Storage compartments too warm</b>	Temperature setting not correct	See Temperature control section
	Frequent door openings Large amount of food recently added	Minimise door openings to allow temperature to stabilise
<b>Food freezing in the refrigerator</b>	Temperature setting not correct	See Temperature control section
	Food placed directly in front of air outlets	Move chill sensitive foods away from the centre back of the shelf
<b>Unfamiliar noises</b>	Cabinet not stable or level Freezer is defrosting	See Installation section
<b>Water in the vegetable bins</b>	Condensation is formed by the water produced by fruit and vegetables	A small amount of condensation is beneficial for fruit and vegetable storage If there is too much water, store fruit and vegetables loosely wrapped in plastic bags Wipe out water with a cloth Set humidity slide to low humidity setting 

## 30 Problem solving checklist

Problem	Possible causes	What to do
Sides of cabinet are warm	This is normal	
Condensation on outside of refrigerator/freezer	Not unusual during periods of high humidity	Wipe dry
Condensation inside fresh food compartment	Frequent or long door openings	Minimise door openings
	Door gasket leaking	Check that gasket is sitting flat and sealing tightly
	Not unusual during periods of high humidity	Wipe dry
Ice buildup inside freezer compartment	Freezer door not closing tightly	Move items in freezer so door can close tightly Check and clean door gasket seal
	In chest freezer over a period of time i.e. will build up this is normal.	Defrost chest freezers if ice build up is more than 6mm deep
Taste or odour in ice cubes	Transfer of odour/taste from strong smelling foods	Wrap or cover strong smelling foods
Door handles out of alignment	With time and usage, movement may occur	See Installation instructions – Stability instructions
Door alarm not working – E240B, E249T, E169T only	Refrigerator compartment light not working	Replace bulb – refer to page 19
Tray/bin does not slide in and out evenly	Packaging trapped	Check to ensure no food or packaging is trapped behind the tray/bin
	Runners not extending fully	Holding onto sides of tray/bin, extend the runners fully by using a firm pull – this will reset the runner.



## Before you call for service or assistance...

Check the things you can do yourself. Refer to your User Guide and check:

- Your appliance is correctly installed
- You are familiar with its normal operation
- You have read the problem solving at the back of the book

If after checking these points you still need assistance please refer to the following...

### In New Zealand if you need assistance...\*

Call your Fisher & Paykel retailer who is trained to provide information on your appliance, or if we can be of any further help, please contact our Customer Care Centre,

**Toll Free: 0800 FP CARE or 0800 37 2273**

**Fax:** (09) 273 0656

**Email:** [customer.care@fp.co.nz](mailto:customer.care@fp.co.nz)

**Postal address:** P.O.Box 58732 Greenmount, Auckland

### If you need service...\*

Fisher & Paykel has a network of independent Fisher & Paykel AUTHORISED SERVICE CENTRES whose fully trained technicians can carry out any service necessary on your appliance. Your dealer or our Customer Care Centre can recommend an AUTHORISED SERVICE CENTRE in your area.

### In Australia if you need assistance...\*

Please call our Fisher & Paykel Customer Care Centre.

**Toll Free: 1300 650 590**

**Fax:** (07) 3826 9298

**Email:** [customer.care@fp.com.au](mailto:customer.care@fp.com.au)

**Postal Address:** P.O. Box 798, Cleveland, QLD4163

### If you need service...\*

Fisher & Paykel Australia Pty Ltd has a network of independent Fisher & Paykel AUTHORISED CUSTOMER SERVICE CENTRES whose fully trained technicians can carry out any service necessary on your appliance. Our Customer Care Centre can recommend an AUTHORISED SERVICE CENTRE in your area.

### In United Kingdom if you need assistance...\*

**Phone:** (0845) 066 2200

**Fax:** (0845) 331 2360

**Email:** [customer.care@fisherpaykel.co.uk](mailto:customer.care@fisherpaykel.co.uk)

**Postal address:** Fisher & Paykel Appliances Ltd, Maidstone Road, Kingston, Milton Keynes, Buckinghamshire, MK10 0BD

### In Ireland if you need assistance...\*

**Phone:** 01800 625 174

**Fax:** 01800 635 012

**Email:** [customer.care@fisherpaykel.ie](mailto:customer.care@fisherpaykel.ie)

**Postal address:** Fisher & Paykel Appliances, Unit D2, North Dublin Corporate Park, Swords, Co. Dublin

### For the rest of the world...\*

Call your Fisher & Paykel Retailer/Dealer from whom you purchased the product. They are trained to provide information on your appliance. If we can be of any further help, please contact us on:

**Phone:** +64 9 273 0660

**Fax:** +64 9 273 0580

**Email:** [international.enquiries@fp.co.nz](mailto:international.enquiries@fp.co.nz)

**Postal address:** Fisher & Paykel Appliances Ltd, PO Box 58550, Greenmount, Auckland, New Zealand

**Feel free to contact us at our website on  
[www.fisherpaykel.com](http://www.fisherpaykel.com)**

\* If you call, write or contact our website please provide: your name and address, model number, serial number, date of purchase and a complete description of the problem. This information is needed in order to better respond to your request for assistance.

### Product details

Fisher & Paykel Appliances Ltd

**Model/Serial No.**

**Date of Purchase** \_\_\_\_\_ **Purchaser** \_\_\_\_\_

**Dealer** \_\_\_\_\_ **Suburb** \_\_\_\_\_

**Town** \_\_\_\_\_ **Country** \_\_\_\_\_



Copyright © Fisher & Paykel 2007. All rights reserved.

The product specifications in this booklet apply to the specific products and models described at the date of issue. Under our policy of continuous product improvement, these specifications may change at any time. You should therefore check with our Customer Care Centre to ensure this booklet correctly describes the product currently available.

**[www.fisherpaykel.com](http://www.fisherpaykel.com)**

NZ AU UK PAC

Refrigerator & Freezer

Installation instructions and user guide

Published 05/2007

**Part No. 837186**