



installation and operating instructions



PL8605XTD dishwasher

1. Safety and operating instructions _____ 4

2. Installation and hook-up _____ 7

3. Description of the controls _____ 10

4. Operating instructions _____ 20

5. Cleaning and maintenance _____ 29

6. Troubleshooting _____ 33

*Thank you for choosing this product.
 We advise you to carefully read all the instructions contained in this manual, in order to understand how to operate your dishwasher safely and correctly.
 The manual is divided into paragraphs, which provide a step by step description of the dishwasher functions, with clear instructions accompanied by detailed illustrations.
 Recommendations are given for the correct use of the baskets, spray arms, containers, filters, washing programs, and for operating the controls.
 Follow the recommended cleaning procedures to ensure that your dishwasher always remains in perfect working order.
 This manual provides a quick and easy reference for answering all your questions concerning the use of your new dishwasher.*



INSTALLATION INSTRUCTIONS: these are intended for the **qualified technician** who must carry out the installation, hook-up and testing of the appliance.



USER INSTRUCTIONS: these consist of recommendations for using the appliance, a description of its controls and of the correct cleaning and maintenance procedures.

1. Safety and operating instructions

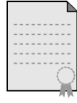

THIS MANUAL FORMS AN INTEGRAL PART OF THE APPLIANCE: IT MUST ALWAYS BE KEPT INTACT TOGETHER WITH THE DISHWASHER. BEFORE USING THE APPLIANCE, CAREFULLY READ ALL THE INSTRUCTIONS CONTAINED IN THIS MANUAL.

INSTALLATION MUST BE PERFORMED BY A QUALIFIED TECHNICIAN, IN COMPLIANCE WITH THE REGULATIONS IN FORCE. THIS APPLIANCE IS INTENDED FOR DOMESTIC USE, AND COMPLIES WITH THE **EEC DIRECTIVES 72/23, 89/336 (INCLUDING 92/31)** CURRENTLY IN FORCE, INCLUDING THE PREVENTION AND ELIMINATION OF RADIO FREQUENCY INTERFERENCE.

THE APPLIANCE IS DESIGNED FOR THE FOLLOWING PURPOSE: **WASHING AND DRYING OF DISHES**; ANY OTHER USE SHALL BE CONSIDERED IMPROPER. **THE MANUFACTURER DECLINES ALL RESPONSIBILITY FOR USES OTHER THAN THOSE DESCRIBED ABOVE.**

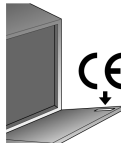

THE NAME PLATE FEATURING THE TECHNICAL DATA, SERIAL NUMBER AND MARKINGS IS VISIBLY POSITIONED ON THE INNER EDGE OF THE DOOR. **THE NAME PLATE ON THE INNER EDGE OF THE DOOR MUST NEVER BE REMOVED.**



DO NOT LEAVE THE DISCARDED PACKAGING MATERIALS UNSUPERVISED WITHIN THE HOME. SEPARATE THE VARIOUS MATERIALS WHICH MAKE UP THE PACKAGING AND TAKE THEM TO THE NEAREST SORTED WASTE COLLECTION CENTRE.

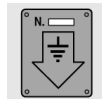

THE APPLIANCE MUST BE PROVIDED WITH AN EARTH CONNECTION IN ACCORDANCE WITH THE ELECTRICAL SAFETY REGULATIONS IN FORCE. **THE MANUFACTURER DECLINES ALL RESPONSIBILITY FOR DAMAGE TO PERSONS OR PROPERTY RESULTING FROM THE FAILURE TO EARTH THE APPLIANCE OR FROM A DEFECTIVE EARTH CONNECTION.**



IF THE APPLIANCE IS INSTALLED ON A CARPETED OR COVERED FLOOR, ENSURE THAT THE OPENINGS ON ITS UNDERSIDE ARE NOT OBSTRUCTED.

ALWAYS SWITCH OFF THE DISHWASHER AFTER EACH USE TO AVOID WASTING ELECTRICITY.



OBSOLETE APPLIANCES MUST BE RENDERED UNUSABLE. CUT OFF THE MAINS POWER CORD AFTER UNPLUGGING IT FROM THE WALL OUTLET, AND MAKE SAFE ANY COMPONENTS WHICH MIGHT BE DANGEROUS FOR CHILDREN (LOCKS, DOORS, ETC.).



THIS APPLIANCE IS MARKED ACCORDING TO THE **EUROPEAN DIRECTIVE 2002/96/EC** ON WASTE ELECTRICAL AND ELECTRONIC EQUIPMENT (**WEEE**). BY ENSURING THIS PRODUCT IS DISPOSED OF CORRECTLY, YOU WILL HELP PREVENT POTENTIAL NEGATIVE CONSEQUENCES FOR THE ENVIRONMENT AND HUMAN HEALTH, WHICH COULD OTHERWISE BE CAUSED BY INAPPROPRIATE WASTE HANDLING OF THIS PRODUCT.



THE SYMBOL  ON THE PRODUCT, OR ON THE DOCUMENTS ACCOMPANYING THE PRODUCT, INDICATES THAT THIS APPLIANCE MAY NOT BE TREATED AS HOUSEHOLD WASTE. INSTEAD IT SHALL BE HANDED OVER TO THE APPLICABLE COLLECTION POINT FOR THE RECYCLING OF ELECTRICAL AND ELECTRONIC EQUIPMENT. DISPOSAL MUST BE CARRIED OUT IN ACCORDANCE WITH LOCAL ENVIRONMENTAL REGULATIONS FOR WASTE DISPOSAL. FOR MORE DETAILED INFORMATION ABOUT TREATMENT, RECOVERY AND RECYCLING OF THIS PRODUCT, PLEASE CONTACT YOUR LOCAL CITY OFFICE, YOUR HOUSEHOLD WASTE DISPOSAL SERVICE OR THE SHOP WHERE YOU PURCHASED THE PRODUCT.

IN THE EVENT OF A FAULT, DISCONNECT THE DISHWASHER FROM THE ELECTRICAL POWER SUPPLY AND SHUT OFF THE WATER TAP.

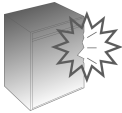

DO NOT USE APPLIANCES WHICH HAVE BEEN DAMAGED DURING TRANSIT! IF IN DOUBT, CONSULT YOUR DEALER. THE APPLIANCE MUST BE INSTALLED AND CONNECTED IN ACCORDANCE WITH THE INSTRUCTIONS PROVIDED BY THE MANUFACTURER OR BY A QUALIFIED TECHNICIAN.



THE APPLIANCE IS INTENDED FOR USE BY ADULTS. DO NOT ALLOW CHILDREN TO COME NEAR OR PLAY WITH THE DISHWASHER. KEEP CHILDREN AWAY FROM DETERGENTS AND FROM THE OPEN DISHWASHER DOOR. THE PACKAGING MATERIALS (PLASTIC BAGS, POLYSTYRENE, METAL BARS, ETC.) MUST NOT BE LEFT WITHIN THE REACH OF CHILDREN.

KEEP CHILDREN AWAY FROM THE OPEN DISHWASHER. THE APPLIANCE MAY CONTAIN RESIDUES OF DETERGENT WHICH CAN CAUSE IRREVERSIBLE DAMAGE TO THE EYES, MOUTH, AND THROAT, AS WELL AS POSSIBLE DEATH BY SUFFOCATION.



DO NOT INTRODUCE SOLVENTS SUCH AS ALCOHOL OR TURPENTINE WHICH MAY CAUSE AN EXPLOSION.

DO NOT LOAD DISHES THAT ARE SOILED WITH ASH, WAX OR PAINTS.

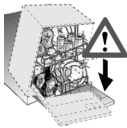

LEANING OR SITTING ON THE DISHWASHER DOOR WHEN OPEN MAY CAUSE THE APPLIANCE TO OVERTURN, PUTING PEOPLE AT RISK. NEVER LEAVE THE DISHWASHER DOOR OPEN; PEOPLE MIGHT TRIP OVER IT.



DO NOT DRINK THE WATER RESIDUES WHICH MAY BE PRESENT INSIDE THE DISHES OR DISHWASHER AT THE END OF THE WASHING PROGRAM AND BEFORE THE DRYING CYCLE.



KNIVES OR OTHER SHARP-ENDED COOKING UTENSILS MUST BE PLACED IN THE CUTLERY BASKET BLADE-DOWN, OR LAID HORIZONTAL IN THE TOP BASKET. TAKE CARE NOT TO CUT YOURSELF AND ENSURE THAT THEY DO NOT PROJECT FROM THE BASKET.



AQUASTOP MODELS

THE AQUASTOP DEVICE PREVENTS FLOODING IN THE EVENT OF A WATER LEAK. WHEN THE AQUASTOP DEVICE IS TRIPPED, CALL IN A QUALIFIED TECHNICIAN TO IDENTIFY AND REPAIR THE FAULT.

IN MODELS EQUIPPED WITH THE AQUASTOP DEVICE, THERE IS A SOLENOID VALVE INSIDE THE WATER INTAKE HOSE. **DO NOT CUT THE HOSE AND DO NOT ALLOW THE SOLENOID VALVE TO DROP INTO WATER.** IN THE EVENT OF DAMAGE TO THE WATER INTAKE HOSE, DISCONNECT THE APPLIANCE FROM THE ELECTRICAL POWER SUPPLY AND FROM THE WATER SUPPLY.



IMMEDIATELY AFTER INSTALLING THE DISHWASHER, PERFORM A QUICK TEST OF THE APPLIANCE FOLLOWING THE INSTRUCTIONS BELOW. IF THE DISHWASHER FAILS TO OPERATE CORRECTLY, DISCONNECT IT FROM THE ELECTRICAL POWER SUPPLY AND CALL THE NEAREST TECHNICAL SERVICE CENTRE. **DO NOT ATTEMPT TO REPAIR THE APPLIANCE.**



THE DISHWASHER MEETS ALL THE REQUIREMENTS SET OUT BY THE REGULATIONS IN FORCE CONCERNING SAFETY AND ELECTRICAL EQUIPMENT. ANY TECHNICAL CHECKS SHOULD BE CONDUCTED EXCLUSIVELY BY A TRAINED AND AUTHORISED TECHNICIAN: **REPAIRS CARRIED OUT BY UNAUTHORISED PERSONS WILL INVALIDATE THE WARRANTY, AS WELL AS POSING A POTENTIAL HAZARD TO THE USER.**

The manufacturer declines all responsibility for damage to persons or property resulting from failure to observe the above precautions, from tampering with even a single component of the appliance, or from the use of non original spare parts.



2. Installation and hook-up

Remove the polystyrene basket retainers.

Position the appliance in the desired place of installation. The back or sides of the dishwasher may be placed up against walls or other furniture units. If the dishwasher is installed near a heat source, fit the special insulating panel to prevent overheating and malfunction of the appliance. To ensure stability, install integrated or built-under dishwashers only under continuous worktops, and screw them to the adjacent units. To facilitate the installation procedure, the intake and drain hoses can be positioned in any direction; make sure that the hoses are not kinked, crushed or pulled too tightly. Make sure to tighten the locking ring-nut once the pipes have been placed in the direction required. A hole at least 8 cm in diameter is required to allow the power supply cable and pipes to pass.

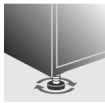

Level the appliance on the floor using its adjustable feet. This operation is essential for ensuring correct operation of the dishwasher.



Building-in a dishwasher underneath a ceramic hob is *absolutely forbidden*.

*A dishwasher can be built-in underneath a conventional hob provided there is **no break** in the kitchen worktop, and the dishwasher and hob are **installed and secured correctly**, so that **no hazards are generated**.*

For free-standing models only

- *Installing a hob on top of a free-standing dishwasher is **absolutely forbidden**.*
- *If the appliance is not built-in and is therefore accessible on one side, the door hinge area must be covered for safety reasons (injury hazard). The covering fixtures are available as an accessory from specialist dealers or the After-Sales Service.*
- *To build in the dishwasher, the **special kit** must be purchased from authorised dealers or the After-Sales Service.*



2.1 Water supply connection



Preventing the risk of clogging or damage: if the water pipe is new or has not been used for a long time, before connecting to the water supply check that the water is clear and free of impurities, to prevent damage to the appliance. **The dishwasher must always be connected to the water system with new hoses; old or used hoses must never be reused.**

CONNECTING TO THE WATER SUPPLY

Connect the intake hose to a cold water supply with $\frac{3}{4}$ " gas thread, inserting the filter **A** supplied with the dishwasher. **Take care to screw the hose firmly into place with your hands and then complete by tightening about $\frac{1}{4}$ of a turn with pliers.**

In dishwashers equipped with the **ACQUASTOP** device, the filters is already fitted inside the threaded ring.

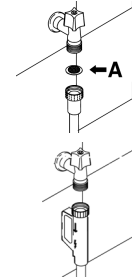

The dishwasher can also be connected to a hot water supply **not exceeding 60°C**. Supplying the appliance with hot water cuts down the washing time by approximately 20 minutes, but slightly reduces its effectiveness. Make the connection to the domestic hot water supply using the same procedure described for connecting to the cold water supply.

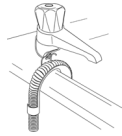

DRAIN CONNECTION

Insert the dishwasher's drain hose into a drain pipe having a diameter of at least **4 cm**, or alternatively, place it inside the kitchen sink using the plastic support provided, taking care not to crush or excessively bend the hose. It is important to prevent the hose from coming loose and falling. For this purpose, the plastic support is equipped with a hole for tying it to the wall or water tap.

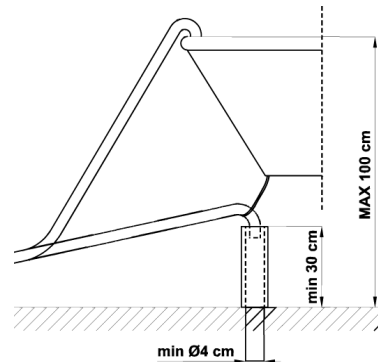

The free end should be positioned at a height of between **30 and 100 cm**, and should never be submerged in water. If a horizontal drain extension hose is used (for a maximum of 3 m) the drain hose can be placed at a maximum height of **85 cm** from the ground.



2.2 Electrical connection and precautions



CHECK THAT THE VOLTAGE AND THE FREQUENCY OF THE MAINS MATCH THE RATINGS ON THE NAME PLATE OF THE APPLIANCE POSITIONED ON THE INNER EDGE OF THE DOOR.



THE PLUG ON THE SUPPLY CORD AND THE CORRESPONDING SOCKET OUTLET MUST BE OF THE SAME TYPE AND MEET THE REGULATIONS IN FORCE.

THE PLUG MUST BE ACCESSIBLE AFTER INSTALLATION.

NEVER DISCONNECT THE PLUG BY PULLING ON THE POWER SUPPLY LEAD.

IN THE EVENT OF DAMAGE TO THE SUPPLY CORD, HAVE IT REPLACED BY THE MANUFACTURER OR AN AUTHORIZED TECHNICAL SERVICE CENTRE.



DO NOT USE ADAPTORS OR SHUNT CONNECTIONS IN ORDER TO AVOID THE POSSIBILITY OF OVERHEATING OR BURNING.



In the event of damage to the supply cord, have it replaced by the manufacturer or an Authorized Technical Service Centre in order to avoid any risk.



3. Description of the controls

3.1 Front panel

All the dishwasher controls are grouped on the front panel.

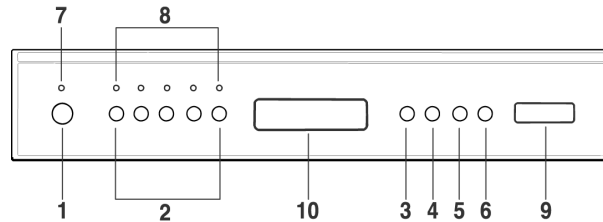

1	ON/OFF BUTTON
2	SELECTION PROGRAM BUTTONS (P1...P5)
3	½ LOAD WASH BUTTON (on some models only)
4	"2/1" OPTION BUTTON (on some models only)
5	DELAY PROGRAM BUTTON (on some models only)
6	START/STOP BUTTON
7	POWER ON LIGHT
8	PROGRAMS INDICATOR LIGHTS
9	INFORMATION DISPLAY
10	RECESSED DOOR HANDLE

3.2 Information display



The dishwasher is equipped with a practical **DISPLAY** which provides information on the programmed dishwasher functions.



PROGRAMME, NUMBER & SYMBOL	LOAD CROCKERY AND CUTLERY	PROGRAM PROGRESS	DURATION	CONSUMPTION		
			MINUTES	WATER LITRES (1)	POWER KWh (2)	
1	SOAK	Pans and dishes awaiting a further wash	Cold prewash	(**)	7	0,03
2	QUICK	Dishes with light dirt	Wash at 38°C Cold rinse Rinse at 58°C	(**)	15	0,92
3	NORMAL (* ECO)	Wash immediately after use for dishes with normal dirt	Cold prewash Wash at 40°C Cold rinse Rinse at 45°C Dry	123	16,9	0,74
4	DAILY	Wash immediately after use for dishes with normal dirt	Wash at 65°C Cold rinse Rinse at 68°C Dry	(**)	16,5	1,54
5	INTENSIVE	Very dirty pans and dishes, even with dried-on dirt	Wash at 70°C 2 cold rinses Rinse at 70°C Dry	(**)	20	1,60
6	DELICATE	Dishes with normal dirt	Cold prewash Wash at 45°C Cold rinse Rinse at 68°C Dry	(**)	19	1,32
7	ECO	Dishes with normal dirt	Cold prewash Wash at 55°C Cold rinse Rinse at 68°C Dry	(**)	16	1,45
8	NORMAL	Normally soiled dishes, including dried-on residue	Cold prewash Wash at 65°C Cold rinse Rinse at 68°C Dry	(**)	20	1,50
9	SUPER	Very dirty pans and dishes, even with dried-on dirt	Prewash at 45°C Wash at 70°C 2 cold rinses Rinse at 70°C Dry	(**)	24	1,85

Only run the soak program with half loads.

The **HALF LOAD** option (3) is available for all programs **except the soak program**.

(*) Reference program as **AS/NZS 2007**. (**) See display.

- (1) Average power consumption with the softener set on **level 2**.
- (2) The cycle duration and power consumption may vary according to the water and room temperatures, and the type and amount of dishes.

TABLE FOR CERTIFICATION BODIES

Reference standard	AS/NZS 2007
Reference program	(*) NORMAL ECO
Load	14 place-settings
Type of detergent	in accordance with AS/NZS 2007
Amount of detergent	pour 10g of cleaner on to the appliance door and 20g into the dispenser
Rinse aid setting	4/6



*The door can be opened at the end of the cycle approximately **50 mm** for improved drying performance.*

AS/NZS 2007 cycle test conditions:

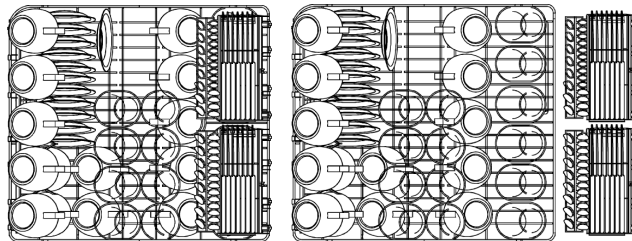
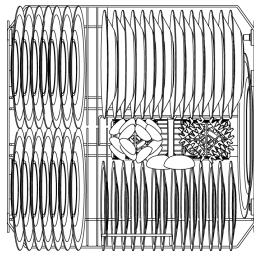

*The **upper basket** must be set in the low position.
Lower basket: the grid "A" ("lower basket" section) must **not** be raised.
Upper basket: on the left, there are **two saucers** underneath the cups.*

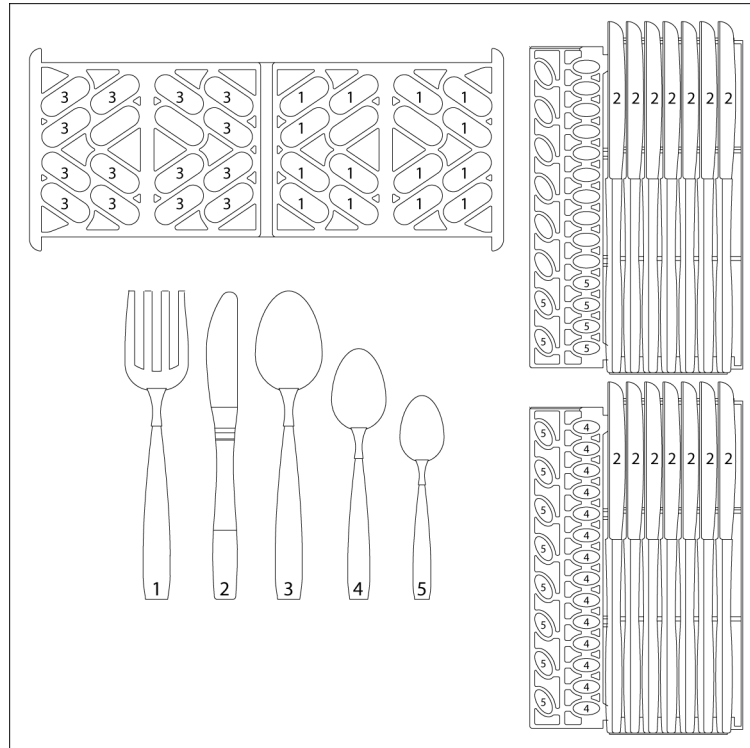

AS/NZS 2007

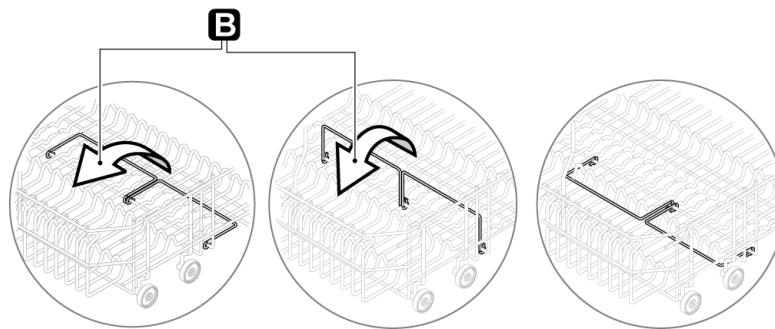

In the **front** there are one or two supports (depending on the models) for **small plates (B)**. To use them, they have to be turned towards the front of the dishwasher.





3.3 Washing programs

The dishwasher is equipped with a control panel and an **INFORMATION DISPLAY (9)** from which it is possible to carry out all the power switch-on, switch-off and programming operations.

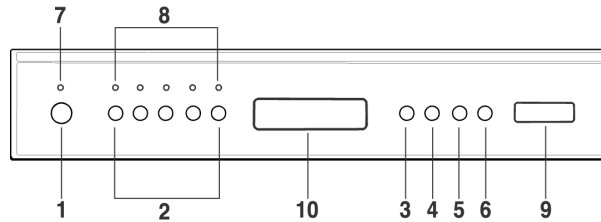

Before starting a washing program make sure that:

- The water supply tap is **open**.
- The **correct amount of detergent** has been added to the **dispenser**.
- The baskets have been **correctly loaded**.
- The spray arms are able to **rotate freely** and without obstruction.
- The dishwasher door is **securely closed**.

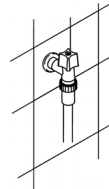

LIGHTING

Pressing the **ON/OFF** button (1) will start the dishwasher and will lit up the dishwasher pilot light (7). After approximately **3 second** from this operation the **DISPLAY (9)** will be turned on with a visualization that will depend upon the state of the dishwasher.



PROGRAMMING

In this dishwasher model all the programming operations are possible only with closed door. With open door, on the **DISPLAY (9)** will appear the symbols -- and the **PILOT LIGHT PROGRAMS (8)** remains out.

SELECTION PROGRAM



The program selection is possible through the relative buttons **(2)**.

By pressing the relative button of desired program (see table) it will lid up the relative pilot light to confirm that the operation did occurred on the **DISPLAY (9)** will appear a program duration forecasting (“h.mm”).



START PROGRAM

At this point, in order to start the machine, it is only enough to press the **START/STOP (6)** for some seconds until the writtin “**Time to end**” start to flash and confirmation “beep” is heard. From this moment the cycle dration on the **DISPLAY (9)** starts to decrease.

This phase, that updates itself during the cycle, is “indicative” since it is influenced by the washing conditions such as dishwasher type and quantity, entry temperature etc. For this reason it is normal to see the updating during a program (increment and decrease of minutes) specially in the passage from one phase to the other (for example, from washing to rinse).

END PROGRAM

The end of the program is indicated by a short signal acoustic and from the “**End**” visual notification on **DISPLAY (9)**. By pressing one of the buttons, the “**End**” visual signal will vanish from the display and the dishwasher is ready to continue a new cycle, the same thing happens when closing or opening the door or by switching on-off the machine.

INTERRUPTING A PROGRAM

In order to interrupt a running program it is necessary:

- to press the **START/STOP (6)** for some seconds until when the writting “**Time to end**” remains lit on the display (confirmation beep). At this point, it is possible to start the cycle again, otherwise:



TO CHANGE A PROGRAM

To change the running program it is necessary:

- to interrupt the running program (see “**INTERRUPTING A PROGRAM**”);
- select the new program;
- to press again the **START/STOP** button (6) to make start the new program.

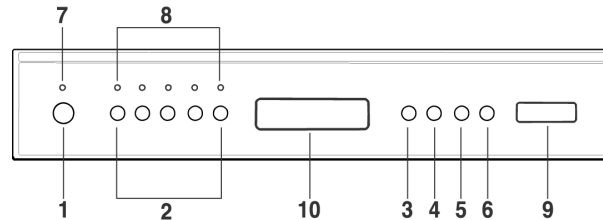

STOPPING A PROGRAM

To stop a program in progress, it must first be interrupted (see “**INTERRUPTING A PROGRAM**”).

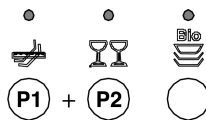

Now press buttons **P1+P2** simultaneously and the first three program lights will come on.

The display will show “**P0**” and the dishwasher will immediately switch to the end of the cycle and drain the tank (during this process, the “**Time to end**” message will flash). When the drain procedure ends, the end of cycle message “**End**” appears on the display.



*In case that the door is opened during the operation, to the next door closing it is going to be necessary to start the program as shown in paragraph “**START PROGRAM**”. The program will resume from the point in which it was interrupted.*

In case that the tub temperature is higher than 50°C the program will start about 30 seconds later.



The washing cycle will not take place if the dishwasher door is left open or not properly closed.



DELAYING THE PROGRAM (on some models only) (available in all programs except the soak program)

The **PROGRAM DELAY** button (5) can be pressed to delay the start of the program by up to **12 hours**. This means that the dishwasher can be operated at the time of day of your choice.

The first time the **PROGRAM DELAY** button (5) is pressed the display will show 12 hours, the maximum delay time before the program will start. Each subsequent time the button is pressed the delay time will be reduced, until the desired delay time is reached.

Particularly, on the display it will have the following indications.

12h [Ⓢ]

Chosen the delay, proceed with the program start, press the button **START/STOP** (6) for some seconds until the clock symbol start to flash.

The machine will perform a dish pre-washing, and when finish, the “delay program” will enter in function as it was first set.

In case you want to put to zero the “delay program” within the running program it is necessary:

- to press the **START/STOP** (6) button for some seconds until the clock symbol remain lid up on the display;
- to press the **DELAY PROGRAM** (5) more times until the reset of the delay program (clock symbol shut off);
- to press the **START/STOP** (6) button to make start the program.

N.B.: It is not possible to select the “delay program” when the program have already began.

"2/1" OPTION BUTTON (on some models only) (available in all programs except the soak program)

By pressing the button (4) you activate the "2/1" option, confirmed when the relative light comes on. This option has been studied for the use of dishwashing powder or tablets with integrated substances in place of rinse-aid known on the market as “2 in 1” or “double action” products; in this case the dishwasher will use the product in an optimal way avoiding salt and rinse-aid consumption, which could already be found in the dishwasher.

Note: When selecting the "2/1" button, it is normal that the rinse-aid light remain on, if the container are empty.

1/2 | **HALF LOAD WASH FUNCTION (on some models only)**

This function is recommended for loads of up to **7 place-settings**, and cuts down on the use of water and electricity. By pressing the **1/2 LOAD WASH (3)** button it is possible to select only upper basket washing.

After having the program selected, continue as follows:

- by pressing for one time the **1/2 LOAD WASH (3)** button, it will select the upper basket and on the display will compare the following visualization;

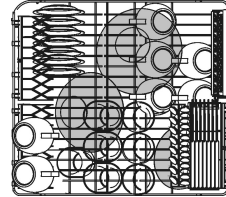

- by pressing a second time the **1/2 LOAD WASH (3)** button it will bring back to the full load washing mode.



One half of the cutlery basket can be placed in the top basket.

WARNING: do not load dishes and cutlery into the lower basket, because the water spray will only reach the top basket.



TO SAVE ON ENERGY! ... AND PROTECT THE ENVIRONMENT

- Always try to run the dishwasher **fully loaded**.
- Do not wash the dishes in running water.
- Use the washing program that is **most appropriate** for each type of load.
- Do not carry out any preliminary rinsing.
- If available, connect the dishwasher to a hot water supply up to 60°C.

TO CUT DOWN ON DETERGENT CONSUMPTION! ... AND PROTECT THE ENVIRONMENT

The phosphates contained in dishwasher detergents are harmful to the environment. To avoid using excessive amounts of detergent and to save on electricity, observe the following:

- **separate** the more delicate items from dishes that are more resistant to aggressive detergents and high temperatures;
- **do not pour** the detergent directly on the dishes.

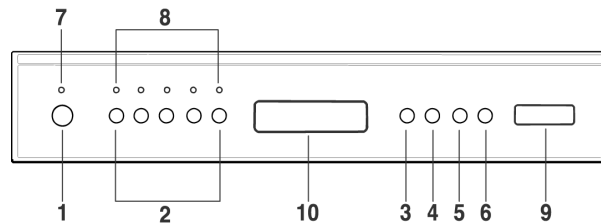

REMOVING THE DISHES

At the end of the washing program, wait at least **20 minutes** before removing the dishes, to allow them to cool down. To prevent any water droplets on the upper basket from falling on the dishes in the lower basket, it is **advisable** to unload the lower basket first, and then the upper basket.



4. Operating instructions

Once the dishwasher has been correctly installed, prepare for use as follows:

- Add the rinse aid and detergent.

4.1 Using the rinse aid and detergent dispensers

The detergent and rinse aid dispensers are situated on the inner part of the door: the **detergent dispenser** is on the left, and the **rinse aid dispenser** is on the right.

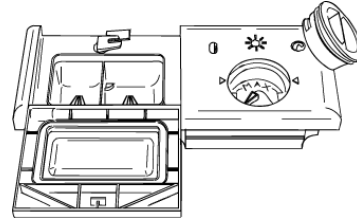

*With the exception of the **SOAK** program, before every washing cycle it is necessary to add the required amount of detergent to the **detergent dispenser**. The rinse aid, on the other hand, should only be added as required.*



ADDING THE RINSE AID

The rinse aid helps the dishes dry faster and prevents the formation of scale deposits and staining; it is automatically added to the water during the final rinse cycle, from the container situated on the inner side of the door.

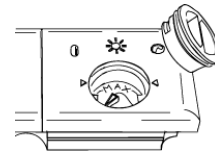

To add rinse aid:

- Open the door.
- Rotate the container cap anticlockwise by $\frac{1}{4}$ of a turn and remove it.
- Add the rinse aid until the container is full (approximately 140 cc). The optical level indicator on the side of the cap should be completely obscured. Refill the rinse aid when the optical level indicator becomes clear again, or when the rinse aid warning light illuminates.
- Replace the cover and turn it in a clockwise direction.
- Use a cloth to remove any spillage of rinse aid which might lead to the formation of excess foam.



ADJUSTING THE RINSE AID DISPENSER SETTING

The dishwasher is factory set for medium water hardness. However it possible to change the setting by turning the dispenser's selector to the desired position: the amount of rinse aid dispensed is proportional to the selector position.

- To adjust the rinse aid setting, rotate the dispenser cap through a quarter turn in an anticlockwise direction and remove it.
- Then use a screwdriver to rotate the rinse aid selector to the desired position.
- Replace the cap, turning it clockwise.



- *The amount of rinse aid must be **increased** if the washed dishes appear dull or feature circular stains.*
- *If, on the other hand, the dishes are sticky or have white streaks, it is necessary to **reduce** the rinse aid setting.*

ADDING THE DETERGENT

To open the detergent dispenser cap, lightly press the button **P**. Add the detergent and close the cap carefully.

During the washing cycle, the dispenser will be opened automatically.

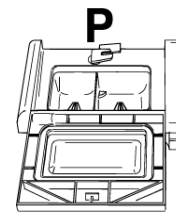

- Use **only** detergents specially formulated for dishwashers. For optimal washing results it is important to use a good quality detergent.
- The detergent packs must be sealed and stored in a dry place to prevent the formation of lumps which may negatively affect washing results. Once opened the detergent packs should not be kept for too long, otherwise the detergent loses its effectiveness.
- Do not use detergents formulated for washing dishes by hand, because they produce a great deal of foam and may negatively affect the operation of the dishwasher.
- Add the correct amount of detergent. An insufficient amount of detergent will result in a partial removal of dirt from the dishes, whereas an excessive amount is wasteful and does not improve the washing results.



- The market offers liquid and powder detergents with differing chemical compositions, which may contain **phosphates**, or be phosphate-free but contain **natural enzymes**.
 - Detergents containing **phosphates** are more effective against grease and starch at **temperatures above 60°C**.
 - **Enzyme** detergents, on the other hand, are also effective at lower temperatures (**from 40 to 55°C**) and are more easily biodegradable. With enzyme detergents it is possible to obtain at low temperatures comparable results to those which can only be achieved at **65°C** using traditional detergents.

For the safeguarding of the environment we recommend the use of **phosphate- and chlorine free** detergents.

- Also available are tablet detergents which state that that no salt or rinse aid is required. In some cases, these detergents might not give good results, especially with short and/or low-temperature washing cycles.

If performance problems (e.g. a white coating on the tank or dishes, poor drying, dirt on dishes at the end of the wash) are noted, users are advised to return to conventional products (granular salt, powder detergent and liquid rinse aid).

However, please note that on return to the use of conventional salt, a number of cycles will be required before the system becomes fully efficient again, so traces of white coating may still be found on the tank and dishes. If the problem persists for too long, contact the After-Sales Service.

- When using detergent in tablet form (bear in mind that we recommend the use of three separate products: detergent, salt and rinse aid), place the tablets in the cutlery rack. The dispenser is designed to use powder or liquid detergent and the door does not open completely during the washing cycle. This means that a tablet is not completely dissolved (released), which may lead to the following:
 - not enough detergent released during the cycle, with poor washing results;
 - the detergent forms a solid block in the distributor and is released during the final rinse cycle.



The introduction of detergent into the rinse aid dispenser, even in liquid form, will damage the dishwasher.



4.2 General warnings and recommendations



Before using the dishwasher for the first time, it is advisable to read the following recommendations concerning dish types to be washed and their loading.

There are generally no constraints on the washing of domestic dishes, but in certain cases it is necessary to take their characteristics into account.

Before loading the dishes into the baskets it is necessary to:

- *remove coarse food remains: e.g. bones, fish-bones, etc. which may clog the filter or damage the wash pump.*
- *soak any pots or pans with burnt-on food remains on the bottom to facilitate removal, then load them into the LOWER BASKET.*

There is no need to pre-wash the dishes under running water before loading them into the baskets since this only wastes water.

Correct loading of the dishes helps ensure optimal washing results.

WARNING!

- *Make sure that the dishes are securely in place so that they cannot tip over or obstruct the rotation of the spray arms during the washing cycle.*
- *Do not place very small objects in the baskets as these could fall and obstruct the spray arms or the wash pump.*
- *Containers such as cups, bowls, glasses and pots should always be loaded with the opening facing downwards and with any cavities at an angle, to allow the water to drain out.*
- *Do not stack dishes or place them in such a way that they cover one other.*
- *Do not place glasses too close together because they may knock against each other and break, or there might be staining at the point where they touch.*

MAKE SURE that the items being washed are dishwasher-safe.

**Items which are not dishwasher-safe:**

- **Wooden dishes, pots or pans:** these may be damaged by the high washing temperatures.
- **Handcrafted items:** these are rarely suitable for washing in a dishwasher. The relatively high water temperatures and the detergents used may damage them.
- **Plastic dishes:** heat resistant plastic dishes must be washed in the upper basket.
- **Dishes and objects in copper, tin, zinc or brass:** these tend to stain.
- **Aluminium dishes:** items made from anodised aluminium may lose their colour.
- **Silverware:** silver items may stain.
- **Glass and crystal:** in general, glass and crystal objects can be washed in the dishwasher. However, certain types of glass and crystal may become dull and lose their clearness after many washings. Therefore, for these items we recommend using the least aggressive program available.
- **Decorated items:** the decorated objects available on the market are generally able to withstand washing in the dishwasher, although the colours may fade after a great many washes. If in doubt as to the fastness of the colours, it is advisable to wash just a few items at a time for approximately one month.



4.3 Using the baskets

The dishwasher has a capacity of **14 place-settings**, including serving dishes.

LOWER BASKET

The lower basket receives the full force of the lower spray arm, and should therefore be used for the "toughest" items with a heavier degree of soiling. All types and combinations of loads are permitted, provided that the dishes, pots and pans are arranged with all the soiled surfaces exposed to the water jets coming from the bottom.

The **rear** of the basket is fitted with a rack to take **large plates (A)**. To use it, simply lift it until it locks in place.

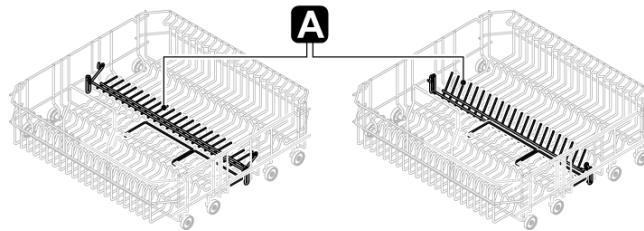

In the **front** there are one or two supports (depending on the models) for **small plates (B)**. To use them, they have to be turned towards the front of the dishwasher.

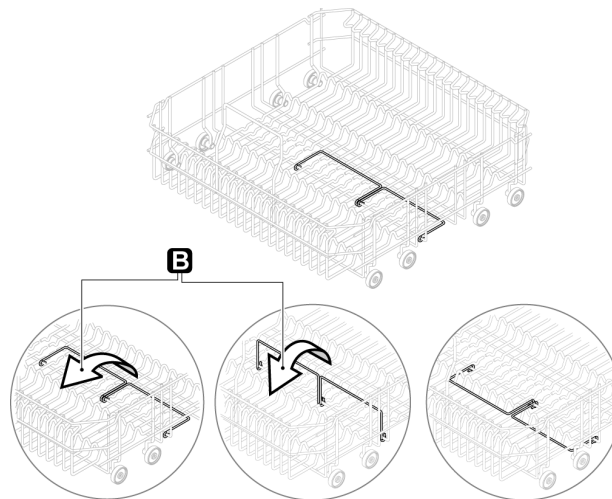



LOADING THE LOWER BASKET

Carefully load flat plates, soup plates, dessert and serving dishes, positioning them vertically. Pots, pans and their covers must be loaded upside down. When loading soup plates and dessert bowls, be sure to leave a gap between them.

Loading examples:

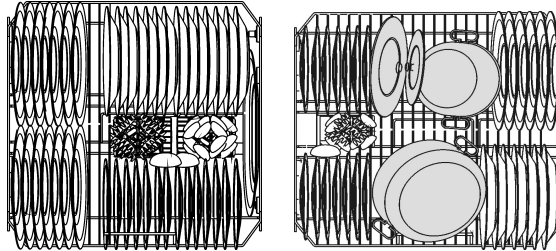

CUTLERY BASKET

The cutlery should be arranged in an orderly manner inside the basket, with the handles pointing downwards. Take care during loading to avoid injury from the knife blades. The basket is suitable for all types of cutlery, except those long enough to interfere with the upper spray arm. Ladles, wooden spoons and cooking knives can be placed in the upper basket, **making sure that the knife blades do not protrude from the basket.**

The cutlery basket features an **exclusive system** of independent **sliding tip-up supports**, offering a series of combinations to allow optimum use of the space available.

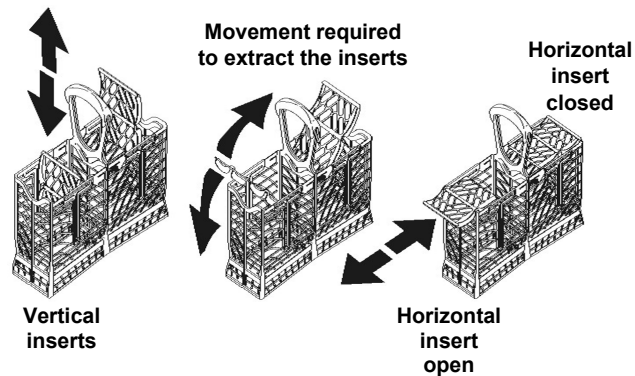



It can also be separated into two parts.

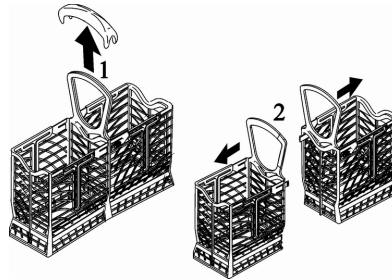

UPPER BASKET

It is recommended to load the upper basket with small- or medium-sized items such as glasses, small plates, tea or coffee cups, shallow bowls and light objects made from heat resistant plastic. If the upper basket is used in the lowermost position, it can also be loaded with serving dishes, provided they are only slightly soiled.

The top basket is fitted (on the left) with two plastic racks which can be raised to make room for tall glasses, such as stem glasses.

On the right there are two cutlery racks designed to take knives and teaspoons; when not in use, they can be left vertical, attached to the basket.

To use the space designed for teaspoons, remove the insert as shown in the illustrations.

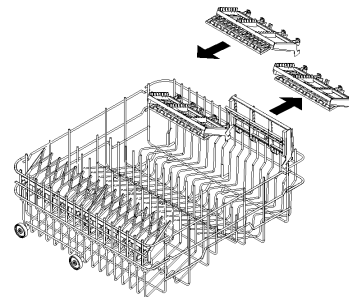



LOADING THE UPPER BASKET

Load the dishes with the top side facing forwards; cups and concave containers should always be loaded with the opening facing down. The left side of the basket can be loaded with cups and glasses on two levels. In the centre section, plates and saucers can be loaded vertically into the supports provided.

Loading examples:

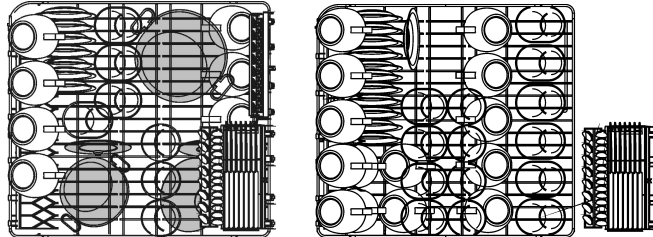

ADJUSTING THE UPPER BASKET

The upper basket can be adjusted in **three different positions** on both sides. The rack must be level on both sides.

To raise the basket lift it, pulling on the front edge **(1)**, to the first or second catch depending on the height required. To lower it, pull the release lever **(2)**.

This is also possible with the basket loaded, but in this case when lowering the basket it should be held steady with one hand to avoid knocking the dishes.

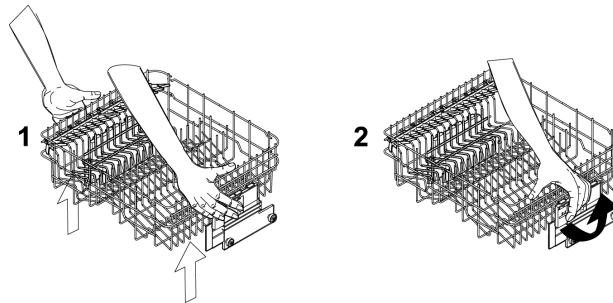



5. Cleaning and maintenance



Before carrying out any work, always unplug the appliance from the electrical supply or switch off the all-pole disconnection device.

5.1 General warnings and recommendations

Avoid the use of acidic or abrasive detergents.

Clean the outer surfaces and door-lining of the dishwasher regularly using a soft cloth moistened with water or with a normal detergent suitable for painted surfaces. Clean the door gaskets with a damp sponge. Periodically (once or twice a year) it is advisable to clean the tank and gaskets, using a soft cloth and water to remove any deposits.

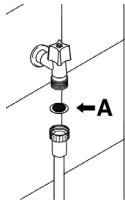

CLEANING THE WATER INTAKE FILTER

The water intake filter **A** located at the outlet of the water supply tap needs to be cleaned periodically.

After having closed the water supply tap, unscrew the end of the water intake hose, remove the filter **A** and clean it delicately under running water. Reassemble filter **A** in its seat and carefully screw the water intake hose back into position.

CLEANING THE SPRAY ARMS

The spray arms can be easily removed for periodic cleaning of the nozzles, to prevent possible clogging. Wash them under running water and carefully replace them in their seats, **checking that their rotary movement is in no way impeded.**

- To remove the **upper** spray arm, unscrew locking ring **R**.
- To remove the **orbital** spray arm assembly, take hold of the longer arm and pull the orbital unit upward. Wash the arms under a jet of running water and return them carefully to their seat. **After reassembly, check that the spray arms turn freely.** Otherwise, check that they have been installed correctly.

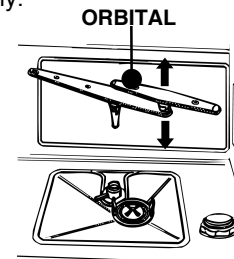
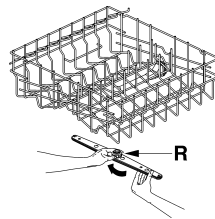



CLEANING THE FILTER UNIT

- It is advisable to periodically inspect the centre filter **C** and, if necessary, to clean it. To remove the filter, grip the tabs, turn them anticlockwise and lift upwards;
- push the centre filter **D** from the underside to remove it from the micro-filter;
- separate the two parts which make up the plastic filter by pressing the body of the filter in the zone shown by the arrows;
- remove the centre filter by lifting it upwards.

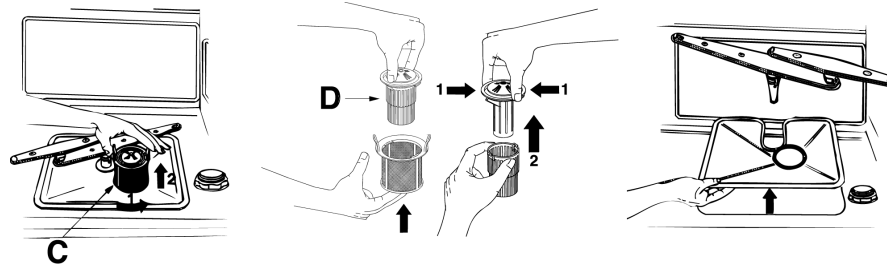

GENERAL WARNINGS AND RECOMMENDATIONS FOR CORRECT MAINTENANCE:

- The filters should be cleaned **under running water** using a stiff brush.
- It is essential to **thoroughly clean the filters** according to the above instructions: the dishwasher cannot function if the filters are clogged.
- **Carefully replace** the filters in their seats, to avoid damaging the wash pump.

PROLONGED DISUSE:

- Run the soak program twice in succession.
- **Unplug** the power cord from the socket.
- **Leave the door slightly open**, in order to prevent the formation of unpleasant odours inside the washing tank.
- **Fill the rinse aid dispenser**.
- **Shut off the water supply tap**.



BEFORE STARTING THE DISHWASHER AFTER PROLONGED DISUSE:

- Check that there are no deposits of sludge or rust inside the water pipe: if there are, allow the water to run from the water supply tap for a few minutes.
- **Plug the power cord** back into the socket.
- **Reconnect the water intake hose and open the tap again.**

TROUBLESHOOTING MINOR PROBLEMS

In some cases it is possible to remedy minor problems by referring to the following instructions:

If the program fails to start, check that:

- the dishwasher is connected to the electrical power supply;
- there is no power failure;
- the water tap is open;
- the dishwasher door is properly closed.

If water remains inside the dishwasher, check that:

- the drain hose is not kinked;
- the drain siphon is not obstructed;
- the dishwasher filters are not clogged.

If the dishes are not being cleaned properly, check that:

- the correct amount of detergent has been added;
- the dishes are being loaded correctly;
- the selected program is suitable for the dish types and their degree of soiling;
- all the filters are clean and positioned correctly;
- the spray arm nozzles are not obstructed;
- there is no object obstructing the rotation of the spray arms.



If the dishes fail to dry or remain dull, check that:

- there is rinse aid inside the special container;
- the rinse aid dispenser setting is correct;
- the detergent used is of good quality and has not lost its effectiveness (for example, through incorrect storage, with the box left open).

If the dishes show signs of streaking, staining, etc., check that:

- the rinse aid dispenser setting is not too high.

If there are visible traces of rust inside the tank:

- the tank is made of steel, and therefore any rust marks are due to external elements (fragments of rust from the water pipes, pots, cutlery, etc.). Special products are commercially available to remove such marks;
- check that the amount of detergent being used is correct. Certain detergents can be more corrosive than others.



If after following the above troubleshooting instructions the problem persists, call the nearest After-Sales Centre.

WARNING: any operations performed on the appliance by unauthorised persons are not covered by the warranty and shall be paid for by the user.



2. Troubleshooting

The dishwasher is equipped with a self-diagnostics system that is capable of detecting and signalling a number of possible faults.

TABLE OF FAULTS DETECTED BY THE SELF-DIAGNOSTICS SYSTEM

FAULT	DESCRIPTION
E1	Acquastop failure The anti-flooding system has been activated (for the relevant models only). The system is tripped in case of water leaks. Contact the after-sales service.
E2	Safety level The system which limits the water level inside the dishwasher has been tripped. Interrupt the program and switch off the dishwasher. Switch the dishwasher back on, program it again and start the washing cycle. If the problem persists, contact the after-sales service.
E3	Water heating malfunction The water is not heated or the heating parameters are not correct. Repeat the washing program; if the problem persists, contact the after-sales service.
E4	Water temperature monitoring malfunction Interrupt the program and switch off the dishwasher. Switch the dishwasher back on, program it again and start the washing cycle. If the problem persists, contact the after-sales service.
E5	Water intake malfunction The appliance does not take in water or does not do so correctly. Check that the water connections are correct, the water intake tap is turned on and the filter is not fouled. If the problem persists, contact the after-sales service.
E6	Water pump-out malfunction The appliance does not pump out the water or does not do so correctly. Check that the drain hose is not kinked or crushed and that the siphon and filter are not fouled. If the problem persists, contact the after-sales service.



FAULT	DESCRIPTION
E7	<p>Turbine flow-regulator malfunction (for the relevant models only)</p> <p>The appliance is not able to "measure" the amount of water loaded accurately. Interrupt the program and switch off the dishwasher. Switch the dishwasher back on, program it again and start the washing cycle. If the problem persists, contact the after-sales service.</p>
E8	<p>Alternate washing system malfunction</p> <p>Interrupt the program and switch off the dishwasher. Switch the dishwasher back on, program it again and start the washing cycle. If the problem persists, contact the after-sales service.</p>
E9	<p>Water intake system malfunction</p> <p>Contact the after-sales service.</p>

- The **E1, E2, E3, E4, E8, E9** alarms provoke the "forcing" to end cycle of the running program.
- The **E5, E6** alarms interrupts the running program once the cause is resolved, it will bring back the execution of the program.
- The alarm **E7** is visualized at the end of the cycle that comes, however, brought to the end since the operation of the dishwasher is not harmed.

To "reset" an alarm is necessary:

- Open and close the door, or turn off and on the machine. At this point is possible to program the dishwasher again.



If the fault persists, call the authorised Technical Service Centre.

TECHNICAL DATA

Width	597 ÷ 599 mm
Depth measured flush with the outer edge of the control panel	Free standing: 600 mm Semi-integrated: 570 mm
Height	Free standing from 890 mm to 910 mm Semi-integrated from 860 mm to 910 mm
Capacity	14 Standard place settings
Water supply pressure	min. 0,05 - max. 0,9 MPa (min. 0.5 – max. 9 bar)
Electrical characteristics	See rating plate

Misurare l'altezza del pannello di comando; fare coincidere l'indice relativo a tale valore con il profilo superiore della porta in legno; tracciare il posizionamento degli agganci della porta.
 Measure the height of the control panel; bring the mark relating to this value in line with the top edge of the wooden door; mark the position of the door connections.
 Mesurer la hauteur du panneau de commandes; faire coïncider l'index relatif à cette valeur avec le profil supérieur de la porte en bois; tracer le positionnement des crochets de la porte.
 Die Höhe des Bedienfelds messen; Die diesem Wert entsprechende Markierung mit dem oberen Profil der Holz-Tür zur Deckung bringen; Die Position der Tür aufhängungen anzeichnen.
 Meet de hoogte van het bedieningspaneel; laat de markering die bij de waarde hoort overeenstemmen met het bovenste profiel van de houten deur; tekende positie van de deurgangels af.
 Medir la altura del panel de mandos; hacer coincidir el índice correspondiente a dicho valor con el perfil superior de la puerta de madera; trazar el posicionamiento de las bisagras de la puerta.
 Межаа алтур до панајел де командос; фаџа ком џе оиндикатор релативо а естевалор коинцида ком о перфилсупериор до порта де madeira; марке а позиџао дос ганџос пар а порта.

115
125
135
145
155

115
125
135
145
155

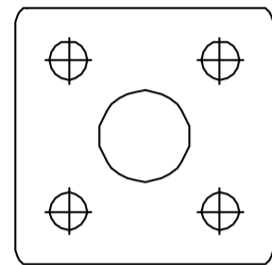

ATTENZIONE:

Montare la porta e regolare la tensione delle molle laterali prima dell'installazione.

IMPORTANT:

Door template, do not destroy. Fit door and adjust hinge tension before installation.

ATTENTION:

Après montage de la porte, régler la tension des ressorts latéraux avant l'installation.

H = 860 - 910 mm

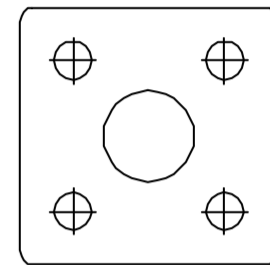
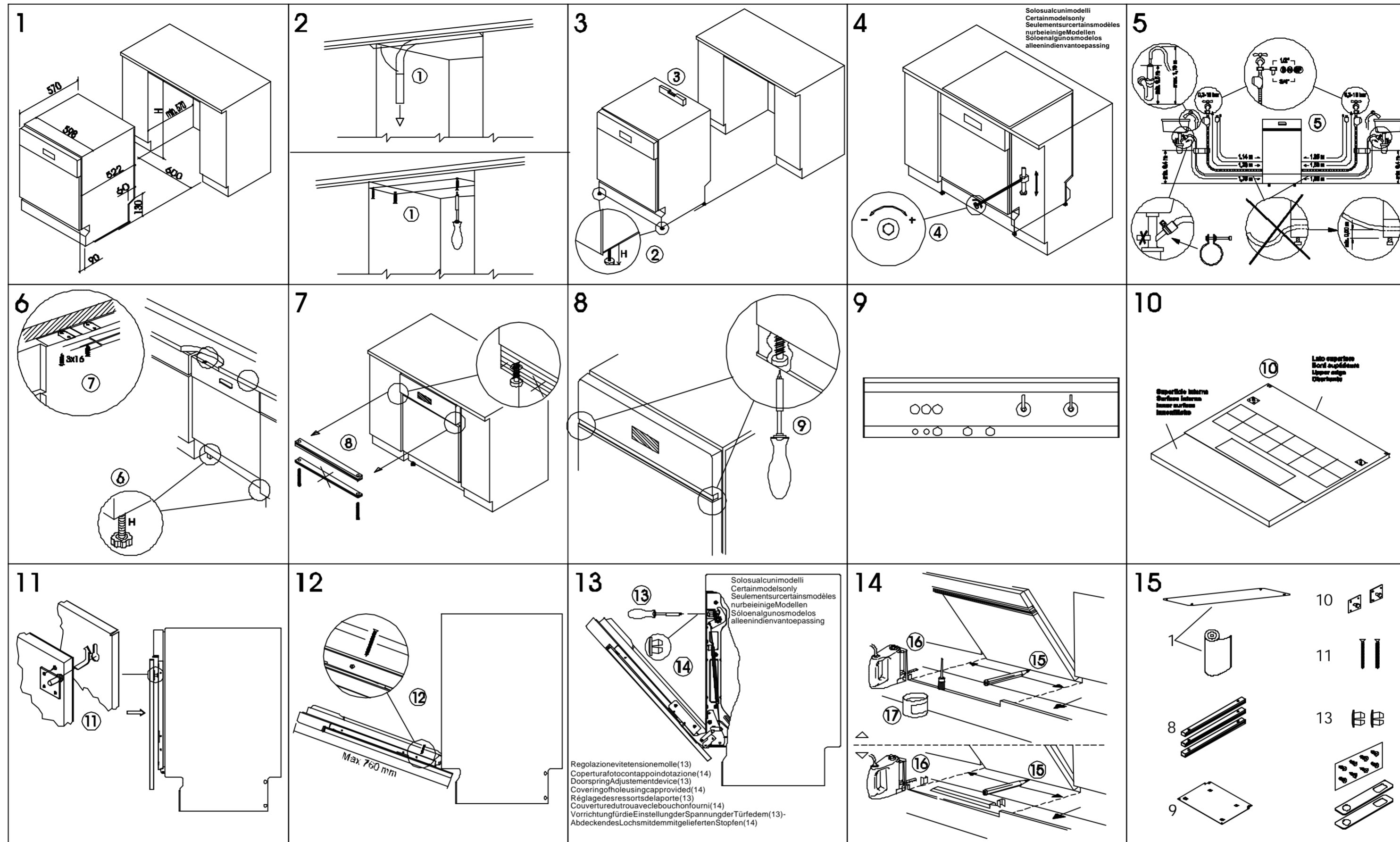

WICHTIG:

Tür montieren, Türfedern vor Einbau einstellen.

ATENÇÃO:

Antes da instalação, monte a porta e regule a tensão das molas laterais.

IMPORTANTE:

Montar la puerta y regular los muelles laterales antes de la instalación.

H = 860 - 910 mm

19 570 0052 00

NOTA: Solamente alcuni modelli sono dotati di uno dei dispositivi sotto illustrati, N.B.: Only some models are equipped with one of the two devices illustrated below. **REMARQUE:** seul quelques modèles sont munis de l'un de deux dispositifs illustrés ci-dessus. **ANMERKUNG:** Nur einige Modelle verfügen über eine der beiden unten dargestellten Einrichtungen. **NOTA BENE:** uitsluitend bepaalde modellen zijn uitgerust met één van de twee onderstaand afgebeelde inrichtingen. **NOTA:** Sólo algunos modelos están equipados con uno de los dos dispositivos que se ilustran a continuación. **NOTA:** Só alguns modelos estão equipados com ou dos dois dispositivos ilustrados abaixo.

Sicurezza contro gli allagamenti
 Questo sistema di sicurezza protegge il vostro appartamento da danni dell'acqua. In caso di guasto al tubo di entrata o permeabilità del sistema della macchina, l'entrata dell'acqua viene interrotta.
 La scatola della sicurezza anti-allagamento montata sul tubo, contiene parti elettriche. E' pertanto proibito collocare la scatola stessa nell'acqua. Nel caso in cui per una ragione qualsiasi la scatola subisca danni, togliere immediatamente la presa di collegamento dalla rete elettrica.
Aquastop-Verlängerung
 Im Handel können längere Aquastopschläuche gekauft werden, die von einem Fachmann mit dem bestehenden Aquastopschlauch ausgetauscht werden müssen. Bei einer eigenmächtigen Verlängerung des Wasserzuleiterschlauches trägt der Hersteller keine weitere Verantwortlichkeit.
"Aquastop" por septuplicado
 El sistema "AQUASTOP" por septuplicado protege su vivienda de forma fiable e de daños por escapes de agua. Se corta inmediatamente el suministro de agua en caso de cualquier fuga en tubos o en componentes del aparato. El cajón de válvulas del tubo aquastop contiene componentes eléctricos. Por este motivo no debe sumergirse en agua. En caso de que el cajón de válvulas estuviera dañado, debe desconectarse de la red eléctrica, desenchufando la clavija.

Aquastop safety device
 The aquastop assures that the fresh water hose need only take the stress of water pressure during the actual time water is flowing. If the hose should begin to leak during this time, the magnetic valve in the water spout cuts off the flow, and the hose is relieved of pressure. Operating pressure DIN 44995.
 The valve casing on the water-stop hose contains electrically controlled components. It is should not, therefore, be submerged in water. If the housing becomes damaged the plug must be removed from the socket.
SLO AQUASTOP - Zaištita pred poplavo
 Ta varnostni sistem varuje vaše stanovanje pred škodo, ki bi jo povzročila voda. V primeru okvare na dovodni cevi ali v primeru puščanja na sistemu porovalnega stroja, se prekine dovod vode. Ohišje ventila oz. varnostne naprave, ki je nameščena na cevi, vsebuje električne dele. Zato je ne smete potopiti v vodo. V primeru, da se ta škaltla iz kakršnegakoli razloga poškoduje, nemudoma izklopite aparat iz električnega omrežja.

YU AQUASTOP - Заштита пред поплавом
 Овај безбедносни систем ваш стан од штете коју може да узрокује вода. У случају квара на доводној цеви или у случају прекида се овога воде. Кућиште вентила односно безбедносне напаве, монтиране на цеви, садржи електричне делове. Зато не смеате да је потапајате у воду. Ус случају да се кућија из било ког разлога оштети, одмах искључите апарат из електричне мреже.
MK AQUASTOP - Заштита од поплава
 Овој заштитен систем го штити вашиот стан од поплава. Во случају на оштетување на доводната цевка или пак ако пропушта систем во машината за мијење садови, се прекинува доводот на вода. Куќаштето на вентилот односно на сигурносната направа која е наместена на цевката, содржи електрични делови и затоа не смеате да ја топите во вода. Ако се случи од било какви причини куќаштето да се оштети, апаратот веднаш исклучите го од електричната мрежа.

Aquastop
 Dieses Wasserschutz-System schützt Ihre Wohnung zuverlässig vor Wasserschaden. Bei undichtem Wasserzuleiterschlauch oder undichtem Maschinensystem wird jeglicher weiterer Wasserzulauf unterbunden. Der Ventilkasten am Wasserstop Schlauch beinhaltet elektrisch gesteuerte Bauteile. Er darf deshalb nicht in Wasser getaucht werden. Sollte das Ventilkastengehäuse beschädigt sein, ist unbedingt der Netzstecker aus zu ziehen.
Paliers de sécurité pour empêcher les fuites
 Le système est doté de sept paliers de sécurité pour éviter les fuites d'eau et protège ainsi votre logement contre d'éventuels dégâts matériels. Si le tuyau d'arrivée d'eau n'est pas étanche ou si la machine fuit, ce dispositif arrête l'écoulement d'eau. Le boîtier de sécurité qui contrôle l'arrivée d'eau est situé sur le tuyau et contient des parties électriques. Il ne faut donc pas le tremper dans l'eau. S'il est endommagé pour une raison quelconque, débranchez immédiatement l'appareil en retirant la prise.

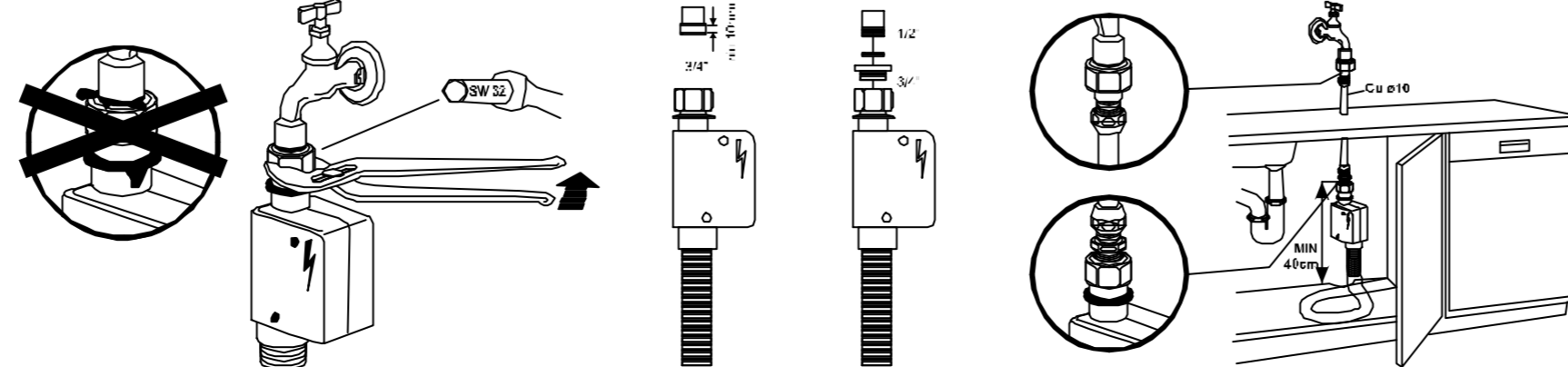

Dispositivo di bloccaggio dell'acqua
 Il tubo di carico dell'acqua è provvisto di un dispositivo di sicurezza che blocca l'afflusso dell'acqua qualora il tubo di carico si deteriori. Questo fatto viene segnalato dall'apparizione di una tacca rossa nella finestrella "A". In questo caso, il tubo di carico acqua dovrà essere necessariamente sostituito.
Water-stop system
 The water-stop device protects against water damages caused by leaks on the hose which could develop due to natural ageing of the hose. In the water-stop system the leaking water fills the corrugated hose and activates a stop valve which cuts off the water supply to the machine. This fault is shown by a red sector on the window "A". Should this occur, please refer to your Service Agent.

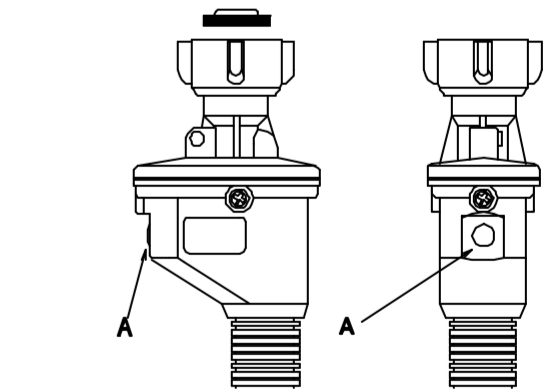

Dispositif de blocage de l'eau
 Le tuyau d'alimentation est équipé d'un dispositif de blocage d'eau. Dans le cas où le tuyau intérieur devrait se détacher à cause d'une usure naturelle, ce dispositif bloquera l'entrée d'eau à l'appareil. Cet inconvénient est signalé par l'apparition d'un secteur rouge dans la petite fenêtre "A". Dans ce cas fermez le robinet d'eau et remplacez le tuyau.
Wasserstop-System
 Der Wasserzuleiterschlauch ist mit einem Wasserstop-System ausgestattet. Sollte der Innenschlauch durch natürliche Alterung beschädigt werden, so blockiert das System die Wasserzufuhr zum Gerät. Die Störung wird durch die Erscheinung einer roten Markierung in Fensterchen "A" angezeigt. In diesem Fall muß der Wasserhahn geschlossen und der Schlauch ersetzt werden.

Dispositivo de bloqueo del agua
 El tubo de carga del agua se encuentra provisto de un dispositivo de seguridad que bloquea el flujo del agua cuando el tubo de carga se deteriora. En este caso, se observará un señal una mancha roja en la ventanilla "A" y será necesario sustituir el tubo de carga del agua.