

Operating instructions

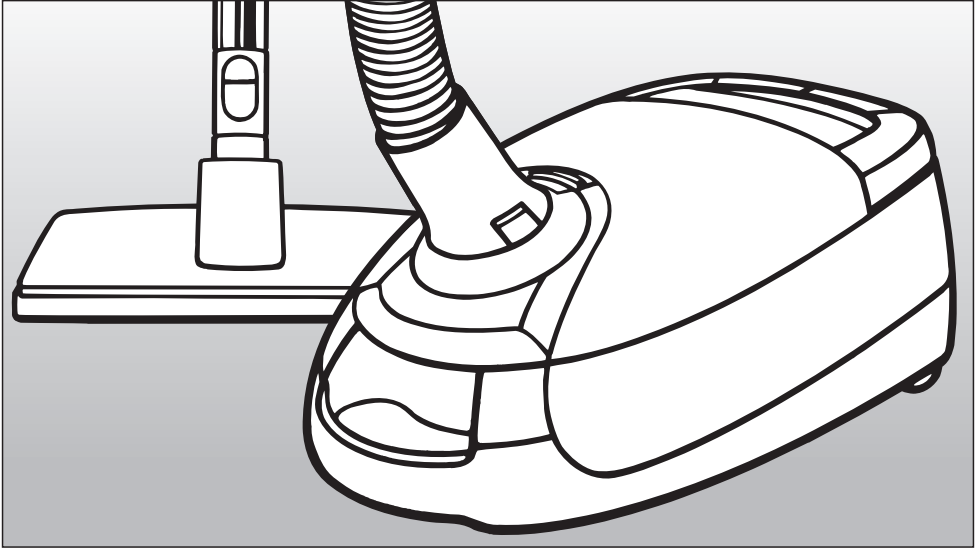

Vacuum cleaners S 5000 series

To avoid the risk of accidents or damage to the appliance, it is **essential** to read these instructions before using it for the first time.

These operating instructions apply to standard models S 5211 - S 5781 and to Special Edition models which are distinguished by names rather than models.

en - AU, NZ

M.-Nr. 07 914 820

Contents

Caring for the environment	3
Description of the appliance	4
Warning and Safety instructions	6
Preparing for use	10
Using the accessories supplied	13
Use	14
Mains cable	14
Switching on and off	15
Adjusting the suction power	16
Opening the air inlet valve	18
Setting down, transportation and storage	19
Maintenance and care	21
Purchasing new dustbags and filters	21
Ordering the correct dustbags and filters	21
When to change the dustbag	22
Replacing the dustbag	23
When to change the exhaust filter	24
Exhaust filter change indicator	24
Replacing the Air Clean filter	25
Replacing an Active Air Clean filter or an Active HEPA filter	26
Replacing one type of filter with another	27
When to change the dust compartment filter (for motor protection)	28
How to change the dust compartment filter	28
When to change the battery in the radio-operated handle	29
How to change the battery in the radio-operated handle	29
When to change the thread lifters	30
To replace the thread lifters	30
Cleaning and care	31
Electrical connection	32
Problem solving guide / After sales service	33
Optional accessories	34

Disposal of packing material

The packing material protects the vacuum cleaner from transport damage. The transport and protective packing has been selected from materials which are environmentally friendly for disposal and can normally be recycled.

Rather than just throwing these materials away, please ensure they are offered for recycling. Sort packing materials for disposal according to type of material (e.g. plastics or cardboard).

Disposing of the dustbag and filters

These are made from environmentally friendly materials, and can be disposed of with the normal household waste, as long as they have been used exclusively for general household dust.

Disposing of your old appliance

Before disposing of your old appliance, remove the dustbag and filter and dispose of them with the normal household waste.

Electrical and electronic appliances often contain materials which, if handled or disposed of incorrectly, could be potentially hazardous to human health and to the environment. They are, however, essential for the correct functioning of your appliance. Therefore, please do not dispose of it with your household waste.

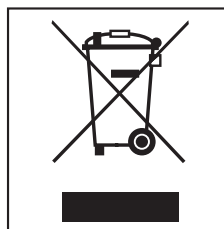

Please dispose of it at your local community waste collection/recycling centre, or contact your Miele Vacuum Cleaner Specialist for advice.

Ensure that your old appliance presents no danger to children while being stored for disposal.

Description of the appliance



The illustration shows the maximum number of features available on these Miele vacuum cleaners.

Certain models are supplied as standard with the following accessories which are not illustrated on this page. These floorheads and brushes are supplied with their own operating instructions.

- Electrobrush
- Turbobrush
- Classic Allergotec floorhead

Description of the appliance

- ① Handle (some models have an air inlet valve in the handle)*
- ② Suction power selector + / -*
- ③ Stand-by button for pauses in vacuuming*
- ④ LED*
- ⑤ Release button
- ⑥ Telescopic tube*
- ⑦ Release buttons for the telescopic tube*
- ⑧ Connection socket
- ⑨ Socket for Electrobrush*
- ⑩ Dust compartment release button
- ⑪ Dust compartment filter (for motor protection)
- ⑫ Dustbag
- ⑬ Floorhead*
- ⑭ Carrying handle
- ⑮ Electrobrush socket cover holder
- ⑯ Parking attachment (on both sides of vacuum cleaner)
- ⑰ Exhaust filter*
- ⑱ Foot switch for automatic cable rewind
- ⑲ Suction power selector*
- ⑳ Mains cable
- ㉑ Exhaust filter change indicator (Re-set button)*
- ㉒ Overheating warning light *
- ㉓ Parking system
- ㉔ Stand-by indicator*
- ㉕ On/Off foot control ①
- ㉖ Release button for accessories compartment
- ㉗ Dustbag change indicator

Those features marked * depend on the model, and may vary or not be available on your model.

Warning and Safety instructions

This appliance conforms to current safety requirements. Improper use of the appliance can, however, present a risk of both personal injury and material damage.

To avoid the risk of accidents and damage to the appliance, please read these instructions carefully before installation and before using it for the first time. They contain important information on its safety, installation, use and maintenance.

Keep these instructions in a safe place and ensure new users are familiar with the content. Pass them on to any future owner.

Correct application

▶ This vacuum cleaner is designed for domestic use and for use in similar environments by guests in hotel or motel rooms, bed & breakfasts and other typical living quarters. This does not include common/shared facilities or commercial facilities within hotels, motels or bed & breakfasts.

▶ The appliance is not suitable for outdoor use.

▶ This vacuum cleaner must only be used to vacuum dry floor surfaces. Do not use on people or animals. Any other usage, modification or alteration is at the owner's risk and could be dangerous. Miele cannot be held liable for damage resulting from incorrect or improper use or operation.

▶ This appliance is not intended for use by persons (including children) with reduced physical, sensory or mental capabilities, or lack of experience and knowledge, unless they have been given supervision or instruction concerning use of the appliance by a person responsible for their safety.

Safety with children

▶ Children should be supervised to ensure that they do not play with the appliance. Keep children away from the appliance at all times to avoid the risk of injury.

▶ Older children may only use the vacuum cleaner if its operation has been clearly explained to them, and they are able to use it safely, recognising the dangers of incorrect use.

▶ Models with radio controls on the handle: Keep batteries out of the reach of children.

Technical safety

▶ Ensure that the connection data on the data plate (voltage and frequency) match the mains electricity supply. This data must correspond in order to avoid the risk of damage to the appliance.

▶ The wall socket must be protected against short circuit by a delay fuse 16 A or 10 A.

Warning and Safety instructions

▶ Before installation, check the appliance for visible signs of damage. Do not use a damaged appliance. A damaged appliance could be dangerous.

▶ Repairs should only be carried out by a Miele authorised service technician. Repairs and other work by unqualified persons could be dangerous. The manufacturer cannot be held liable for unauthorised work.

▶ The socket on the vacuum cleaner must only be used for the Miele PowerBrushes specified for use with this appliance (depending on model).

▶ There is a metal inlay underneath the handle which is designed to avoid the unpleasant effects of electrostatic discharges. Please make sure that you keep your hand in constant contact with this metal strip during vacuuming.

▶ Do not use the vacuum cleaner if the cable is damaged. A damaged cable is dangerous.

▶ Do not pull or carry the vacuum cleaner by the cable and be careful not to damage the cable when withdrawing the plug from the socket. Keep the cable away from sharp edges and do not let it be squashed, for example, under a door.

Avoid running the vacuum cleaner over the cable.

This could damage the cable, plug or socket and pose a safety hazard. The appliance must not be used if any of this damage has been suffered.

▶ If the cable is damaged, it must be replaced together with a complete cable rewind. For safety reasons, this must only be done by the Miele Service Department or by a Miele authorised service technician.

▶ While the vacuum cleaner is under warranty, repairs should only be undertaken by a service technician authorised by Miele. Repairs and other work by unqualified persons could be dangerous. The manufacturer cannot be held liable for unauthorised work.

▶ It is important to switch the vacuum cleaner off before changing over accessories and floorheads.

▶ It is important to switch off the vacuum cleaner after use and before any cleaning or maintenance. Switch off at the wall socket and remove the plug.

▶ Do not let the vacuum cleaner get wet. Clean only with a dry cloth, slightly damp cloth or suitable proprietary cleaner when disconnected from the mains supply. If moisture gets into the appliance, there is a risk of electric shock.

Warning and Safety instructions

Correct use

▶ To avoid the risk of damage, do not use the vacuum cleaner without the dustbag, dust compartment filter and exhaust filter in place.

▶ If a dustbag is not inserted, the dust compartment cover cannot be closed. Do not force it.

▶ Do not vacuum up anything which has been burning or is still glowing e.g. cigarettes, ashes or coal, even if apparently extinguished. The vacuum cleaner might catch fire.

▶ Do not vacuum up any water, liquid or damp dirt. This will cause major faults and could seriously impair the functioning and electrical safety of the appliance. Wait until any freshly cleaned or shampooed carpets or floor coverings are completely dry before attempting to vacuum.

▶ Do not vacuum toner dust. Toner, such as that used in printers and photocopiers, can conduct electricity. The filter system in the vacuum cleaner may not filter it completely, causing the toner to be blown back into the room by the fan.

▶ Do not vacuum up any inflammable or combustible liquids or gases and do not vacuum in areas where such substances are stored. The vacuum cleaner might explode.

▶ Do not vacuum up items which are heavy, hard or have sharp edges. They could cause a blockage and damage the appliance.

▶ Floor attachments, accessories and tubes must not be used at head level to avoid the risk of injury, e.g. to eyes and ears.

▶ Monitor the change dustbag indicator and change the dustbag if necessary.

Check the exhaust and dust compartment filters at the same time and change them too if necessary. A full bag or blocked filter will reduce the suction power of the vacuum cleaner. A temperature limiter switches the vacuum cleaner off automatically if it gets too hot. See "Problem solving guide".

▶ Important information on the handling of batteries (for models with radio controls on the handle):

- Do not short circuit or recharge batteries, or throw them into a fire. Danger of explosion!
- Disposing of batteries: Remove the batteries from the radio control handle and dispose of them at a local battery recycling bin. Do not dispose of them with the normal household waste.

Accessories

▶ The Miele PowerBrush is a motor driven accessory for use only with Miele vacuum cleaners. The vacuum cleaner must not be used with a PowerBrush produced by another manufacturer.

▶ To avoid the risk of injury when vacuuming with a Miele PowerBrush or TurboBrush, do not touch the rotating roller brush.

▶ It is not advisable to vacuum directly with the handle, i.e. without an accessory attached, as the rim could get damaged and you could hurt yourself on sharp edges.

▶ Miele vacuum cleaner bags are disposable and intended to be used only once. Dispose of full dustbags. Do not attempt to re-use. Blocked pores reduce the efficiency of the vacuum cleaner.

▶ Only use genuine Original Miele dustbags, filters and accessories. This will ensure optimum performance of the appliance throughout its life.

The manufacturer cannot be held liable for damage caused by non-compliance with these Warning and Safety instructions.

Preparing for use

Attaching the suction hose

- Insert the hose connector into the socket until it clicks into position. To do this, line up the guides on the two pieces.

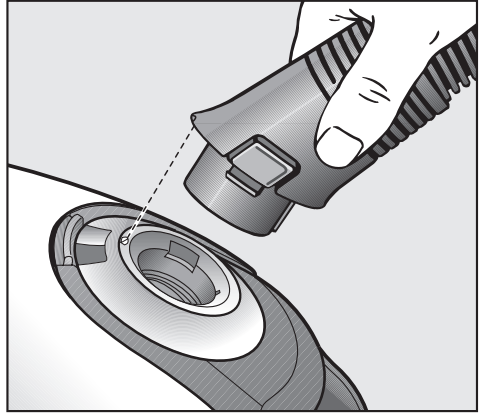

To remove the suction hose from the cleaner

- Press the release buttons at the side of the hose connector, and lift the hose from the socket.

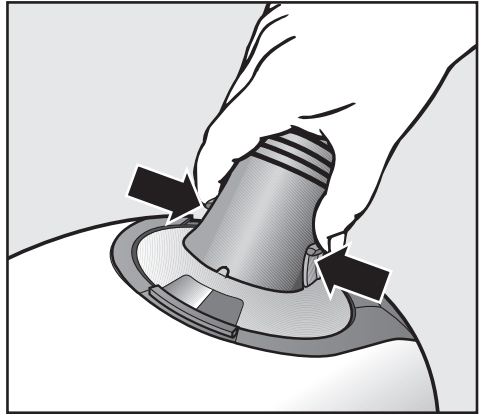

Connecting the handle to the suction tube

- Insert the handle into the suction tube until it clicks into position. To do this, line up the guides on the two pieces.
- To release the handle from the suction tube, press the locking button (see arrow) and pull the handle away from the suction tube.

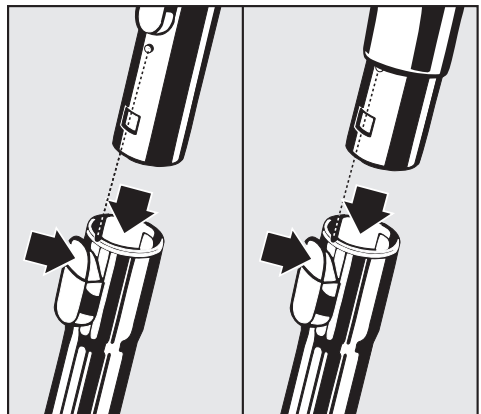

Your vacuum cleaner is fitted with one of the following telescopic tubes, depending on the model:

- 2-part telescopic tube
- Triscopic telescopic tube

Adjusting the telescopic suction tube

One part of this telescopic tube is packed inside the other and can be adjusted to suit your height for comfortable vacuum cleaning.

- Press the telescopic tube release button (see arrow) to release the tubes and adjust to the required height.

Adjusting the triscopic suction tube

The triscopic tube has three sections. Two sections of the telescopic tube are packed together inside a third outer tube.

- Press the release button (see arrow ①) to release the lower tube and pull it right out until it clicks. Press the button again when you want to retract the tube again. The tube will click into place.
- Press the telescopic tube release button ② to release the tubes and adjust to the required height.

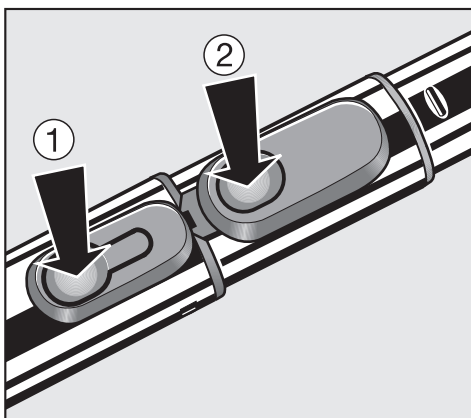
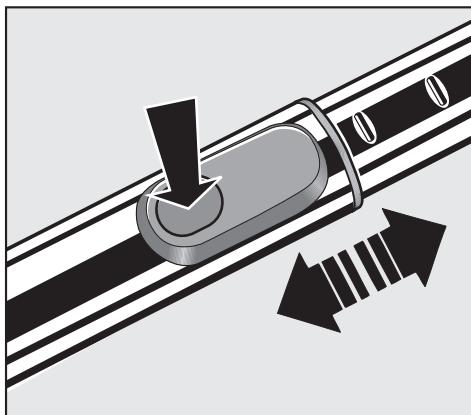

Preparing for use

Fitting the standard floorhead

- Push the suction tube into the floorhead and turn it clockwise or anti-clockwise until it clicks into position.
- To release the floorhead from the suction tube, press the locking button (see arrow) and pull the suction tube away from the floorhead.

The floorhead can be used for all normal cleaning of carpets and rugs. It can also be used with the brush protruding to vacuum hard flooring. For hard flooring, such as stone and parquet, we recommend using one of the special Miele floor brushes (see "Optional accessories").

It is important in the first instance to observe the flooring manufacturer's cleaning and care instructions.

Vacuum carpets and rugs with the brush retracted:

- Press the foot control .

Clean hard flooring which is not susceptible to scratching with the brush protruding:

- Press the foot control .

Always clean hard flooring with deep cracks or spacing between floorboards with the brush protruding.

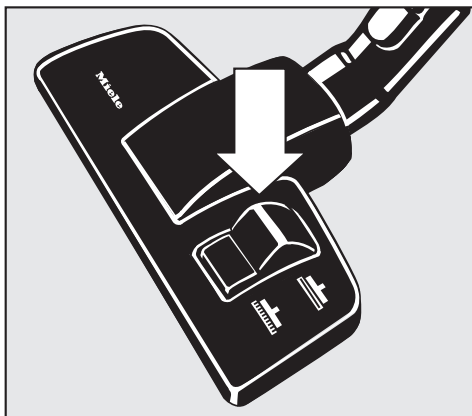
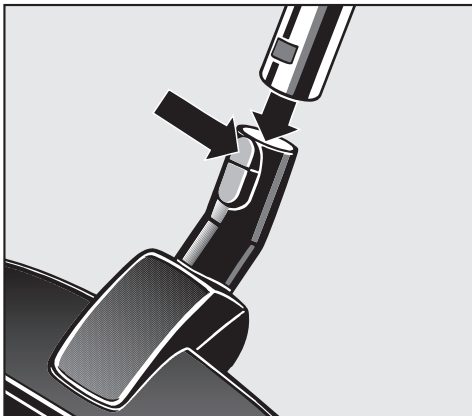

The Classic Allergotec floorhead, the Turbobrush and the Electrobrush

Some models may be supplied as standard with one of these accessories (see "Optional accessories").

Please refer to the separate operating instructions supplied with these brushes for instructions on use and maintenance.

Using the accessories supplied

The following accessories are supplied:

- ① Crevice nozzle
For cleaning in folds, crevices or corners.
- ② Dusting brush
For cleaning skirting boards, ornate or carved articles, etc. The head of the dusting brush can be swivelled to attain the best cleaning position.
- ③ Upholstery nozzle
For cleaning upholstery, mattresses, cushions, curtains, covers etc.



To open the accessories compartment

- Press the release button to open the accessories compartment lid.
- Take out the accessory you require.
- Press down firmly on the lid to close it.

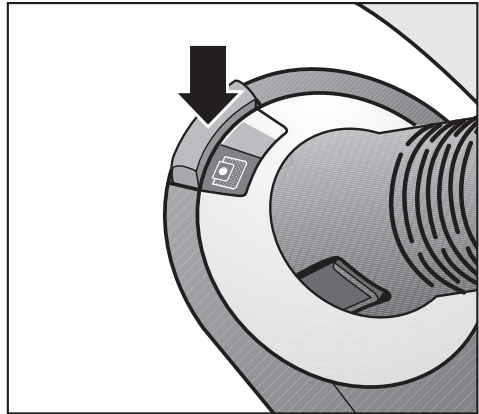

Floorhead

For general use and also for vacuuming the stairs.

For safety reasons when vacuuming stairs it is best to start at the bottom of the stairs and move upwards.

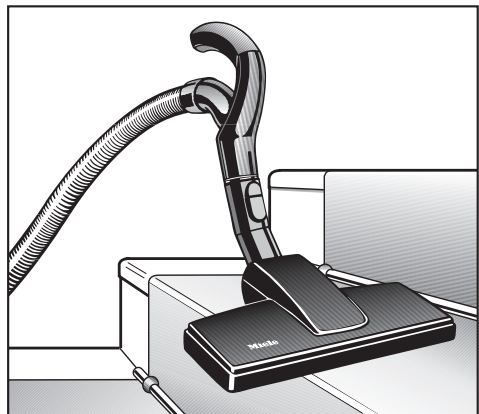

Use

Mains cable

Unwinding the cable

- Pull out the mains cable to the required length (max. approximately 6.5 m).

 If vacuuming for longer than 30 minutes, the mains cable must be pulled out to its fullest extent. Otherwise there is a danger of overheating and damage.

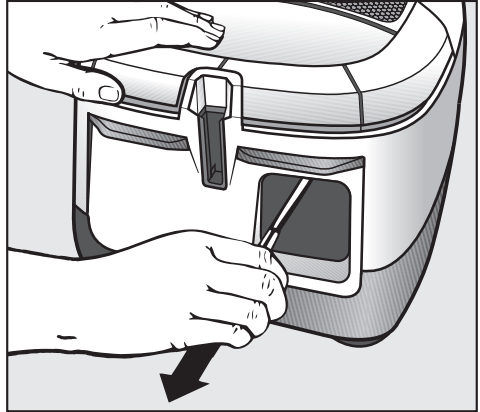

Rewinding the cable

- Switch off at the wall socket and remove the plug.
- Press the rewind foot switch. The cable will rewind automatically.

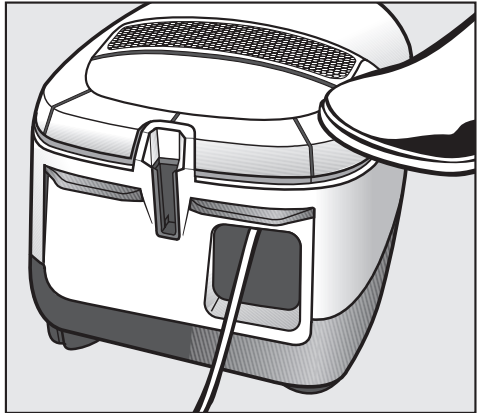

Switching on and off

- Step on the On/Off foot switch ①.

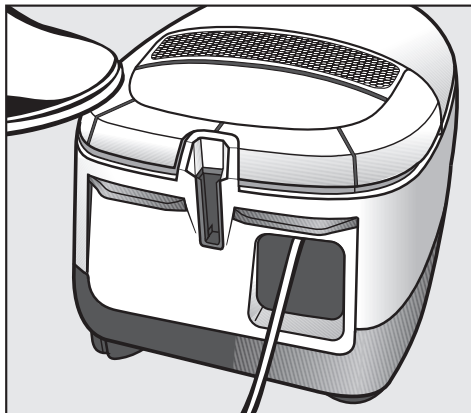

Models with radio controls on the handle

To pause the appliance during operation:

- Press the stand-by button on the handle.

 The stand-by button is designed to pause the vacuum cleaner for short periods of time whilst vacuuming. There is a risk of overheating or damage if left in stand-by mode for too long.

An LED will indicate each time a button is pressed on the handle.

At the end of the pause, you can do one of the following:

- Press the stand-by button again to switch the vacuum cleaner back on at the setting you were using before pausing it.
- Press the + button to switch the vacuum cleaner back on using the highest power setting.
- Press the - button to switch the vacuum cleaner back on using the lowest power setting.

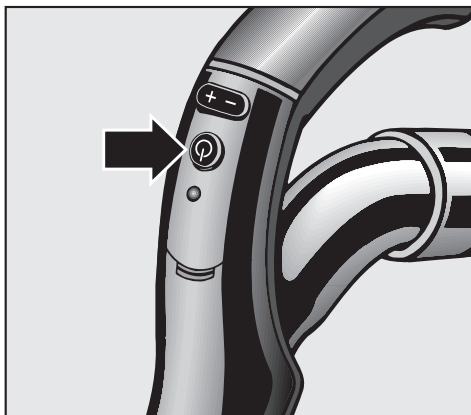

Vacuuming





- When vacuuming, pull the cleaner behind you on its wheels. You can stand it upright for vacuuming stairs and curtains etc.

 When vacuuming especially fine dust, e.g. sawdust, sand, plaster, flour, talcum powder etc., electrostatic charges build up naturally. Under certain conditions these charges will be released. To avoid the unpleasant effects of these discharges, a metal inlay has been incorporated into the underside of the handle. Please make sure that you keep your hand in constant contact with this metal strip during vacuuming.

Adjusting the suction power

The suction power can be regulated to suit the type of flooring. The higher the wattage, the more powerful the suction. Reducing the suction power reduces the amount of effort required to manoeuvre the floorhead.

Some models also have symbols on the controls. The symbols indicate the type of use the settings are suitable for:

-  - Curtains, lightweight fabrics
-  - Upholstery, cushions
-  - High quality velour carpets, rugs and runners
-  - For daily energy-saving vacuuming with a low operating noise level
-  - Loop-pile carpets and rugs
-  - Hard flooring, and for intensive cleaning of carpets

The controls vary from model to model. The different options are carried out in sequence.

Rotary selector

- Turn the suction power selector manually to the suction power setting you require.

On some models, the selected setting lights up green.

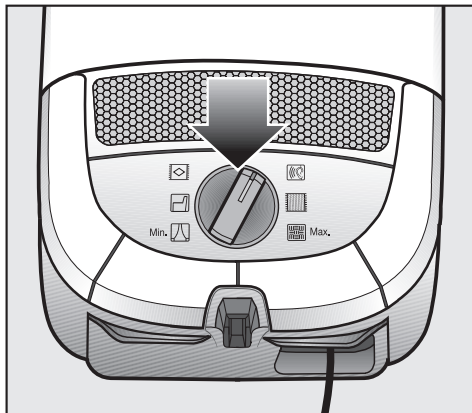

+ / - foot controls

Press and hold the + or - foot control until the power setting you require lights up green.

- Press the + control to select a higher setting.
- Press the - control to select a lower setting.

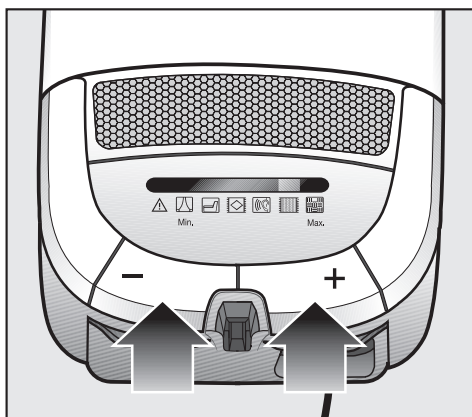

+ / - foot controls with AutoEco setting

When you switch your vacuum cleaner on the energy saving "AutoEco" setting is selected automatically.

- Press the + control to change to "Turbo", the highest power setting.
- Press the - control to change to "Min.", the lowest power setting.

The power setting which is currently selected will light up white.

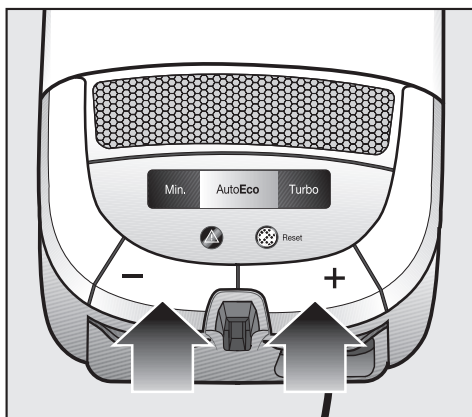

Use

+ / - controls on the handle (radio-operated)

Press and hold the + or - button until the symbol for the power setting you require shows in the display on the cleaner.

- Press the + control to select a higher setting.
- Press the - control to select a lower setting.

The LED will indicate each time a button is pressed on the handle.

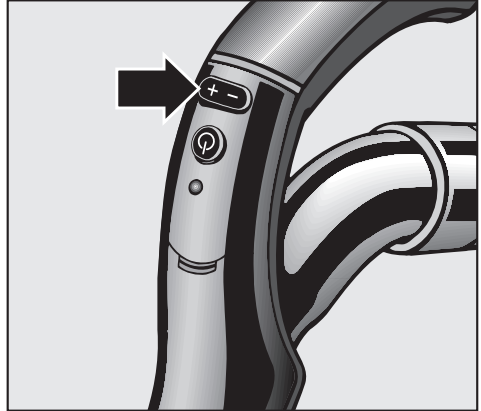

Opening the air inlet valve

(not on models with radio-controls on the handle)

It is easy to reduce the suction power for a short time, e.g. to prevent rugs or other objects being sucked into the vacuum cleaner.

- Open the air inlet valve far enough to reduce the suction power.

The floorhead will be easier to manoeuvre. Close the valve up again when you are ready to use full power again.

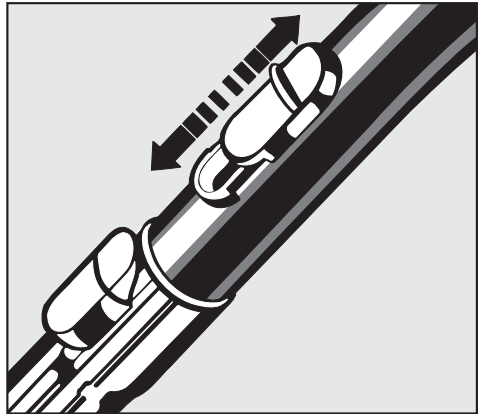

Setting down, transportation and storage

Parking system

A parking system has been designed for conveniently parking the vacuum cleaner during pauses.

- Slot the floorhead into the parking attachment at the back of the vacuum cleaner.

If the vacuum cleaner is parked on a sloped surface, e.g. on a ramp, retract all parts of the telescopic wand completely.

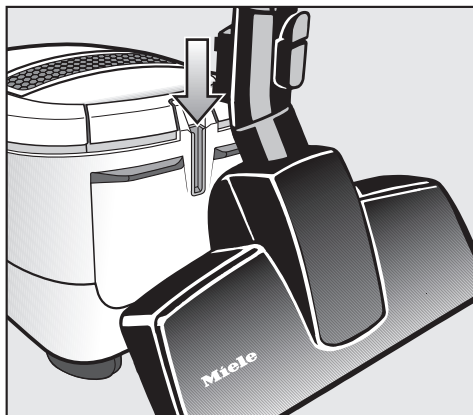

Switching on and off with the parking system

Some models are fitted with an On/Off switch in the parking system.

The cleaner is automatically switched off when the floorhead is placed in the parking attachment. Lifting the floorhead out of the parking attachment automatically switches the cleaner on again.

If your vacuum cleaner is equipped with "+ / - foot controls" or "+ / - foot controls with "Auto**Eco**" setting, you can de-activate or activate the parking system's On/Off function.

- Switch the vacuum cleaner off with the On/Off foot control.
- Press and hold the + and - foot controls in, and at the same time switch the vacuum cleaner on with the On/Off foot control.

Setting down, transportation and storage

Transportation and storage

- Stand the vacuum cleaner upright when it is not being used and during storage.
- Slot the floorhead downwards into one of the parking attachments on either side of the vacuum cleaner.
- Retract the telescopic tube fully.

This makes the cleaner easier to carry or store.

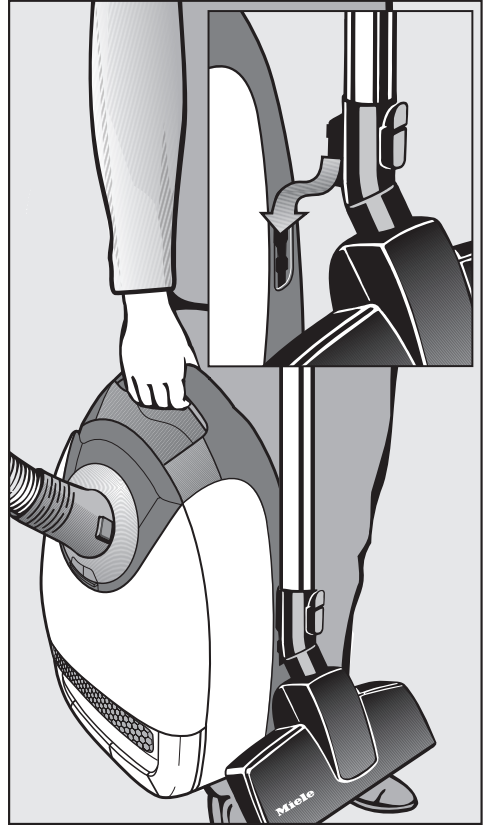

 Always disconnect the vacuum cleaner from the electrical supply for maintenance work and for cleaning. Switch off at the wall socket and remove the plug.

The Miele filter system consists of three filters which must be replaced from time to time to ensure that your cleaner performs efficiently.

- Dustbag
- Exhaust filter
- Dust compartment filter (for motor protection)

Only use Original Miele dustbags and filters. This ensures that your vacuum cleaner functions correctly and cleans hygienically.

 The use of non-Miele dustbags, paper dustbags as well as dustbags with cardboard holders can cause serious damage to the vacuum cleaner and will invalidate your warranty.

Purchasing new dustbags and filters

Original Miele dustbags can be ordered via the internet at www.miele-shop.com, from Miele (see back cover for contact details) or from your Miele Vacuum Cleaner Specialist.



Ordering the correct dustbags and filters

You can recognise Original Miele dustbags type **G/N** and genuine Miele filters by the "Original Miele" logo on the packaging or on the dustbags.



An Air Clean filter and a dust compartment filter are supplied with every packet of Miele dustbags. If you wish to purchase exhaust filters or dust compartment filters separately, please quote the model number of your appliance when ordering to ensure you get the correct items. You can also order all accessories via the Miele website www.miele-shop.com.

You can replace the exhaust filter fitted in the vacuum cleaner with one of the other Miele exhaust filters if you wish (see "Optional accessories").

Maintenance and care

When to change the dustbag

Change the dustbag when the colour marker in the dustbag change indicator fills the display, or sooner if it is no longer effective (see possible reasons for this below).

Miele vacuum cleaner bags are disposable and intended to be used only once. Dispose of full dustbags. Do not continue to use them once they are full as blocked pores reduce the efficiency of the vacuum cleaner.

Checking the dustbag change indicator

- Attach the standard floorhead to the suction tube. Do not use any of the other floorheads or attachments as they will cause the dustbag change indicator to give a false reading.
- Switch on the vacuum cleaner using the On/Off foot control , and select the highest power setting.
- Lift the floorhead off the floor a little. If the marker completely fills the dustbag change indicator, you should replace the dustbag with a new one.

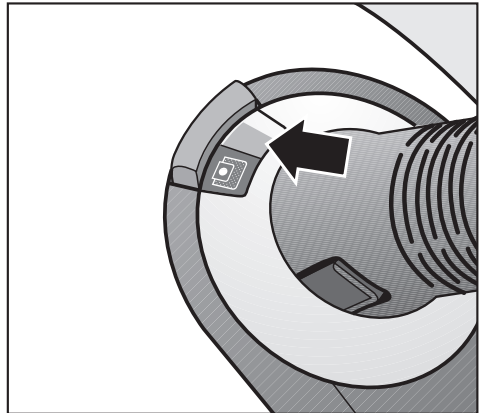

How the dustbag change indicator works

The dustbag change indicator is set for normal household dust. Normal household dust would contain a mixture of dust, hair, carpet fluff, threads, grit etc.

However, if the vacuum cleaner has been used to suck up fine dust, the pores of the dustbag will become blocked very quickly. This affects the air permeability of the bag, and the marker will indicate that the bag is "full" even when it is not. If this happens you must still change the dustbag because suction power will be greatly reduced by blocked pores in the dustbag.

If, on the other hand, you have vacuumed up a large amount of hair and carpet fluff which typically contains a lot of air, the indicator may fail to react even though the bag is full. You should still change it!

Both these extremes can occur.

Replacing the dustbag

- Press the release button for the dust compartment lid and raise the lid as far as it will go.

The dustbag has a closing flap which closes automatically when the dust compartment lid is raised to prevent any dust escaping.

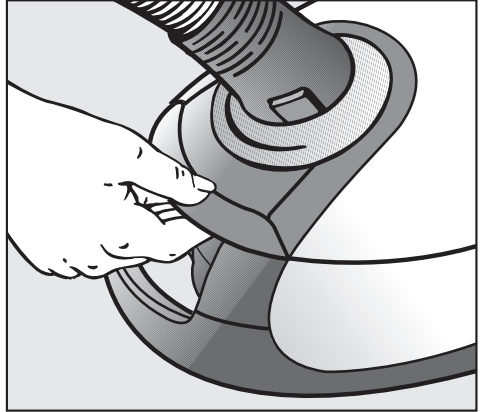

- Pull the dustbag out by the grip next to the self-closing flap on the collar.

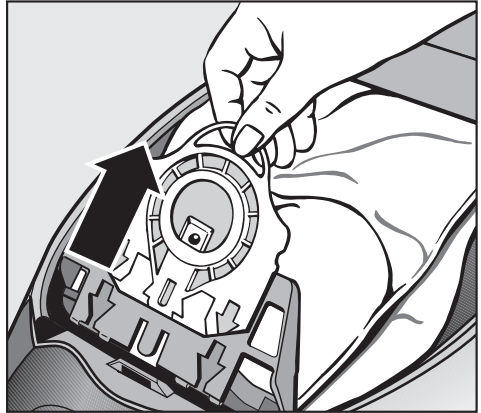

- Fit the new dustbag into the holder as far as it will go. Leave it folded up when you take it out of the box.
- It should be unfolded in the dust compartment.
- Close the dust compartment lid securely, making sure it clicks into position. Take care not to trap the dustbag when doing so.

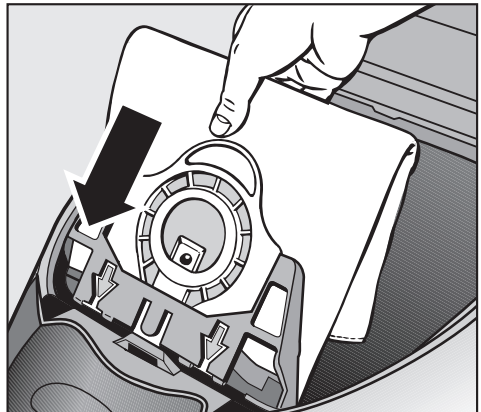

 The lid will not close without a dustbag in place. Do not force it.

Maintenance and care

When to change the exhaust filter

Depending on the model, your vacuum cleaner will be fitted as standard with one of the following exhaust filters:

a an Air Clean filter

Replace this filter every time you start a new packet of Miele dustbags. An Air Clean exhaust filter and a dust compartment filter are supplied with every packet of Miele dustbags.

b an Active Air Clean filter SF-AAC 50 (black)

c an Active HEPA filter SF-AH 50 (blue)

These types of filter need to be changed approximately once a year. Make a note of the date on the filter.

Exhaust filter change indicator

Certain models are fitted with an exhaust filter change indicator (reset control) to show when to change your Active Air Clean **b** or Active HEPA **c** filter.

The indicator lights up after approximately 50 hours of operation, which is equivalent to about a year of average use. You can continue vacuuming when the light comes on. However, the suction power will be reduced as will the effectiveness of the filter if it is not replaced in good time.

The filter change indicator light is irrelevant if an Air Clean filter (**a**) is being used, as long as it is replaced every time a new packet of Miele dustbags is started. The indicator light will go out when the reset button is pressed.

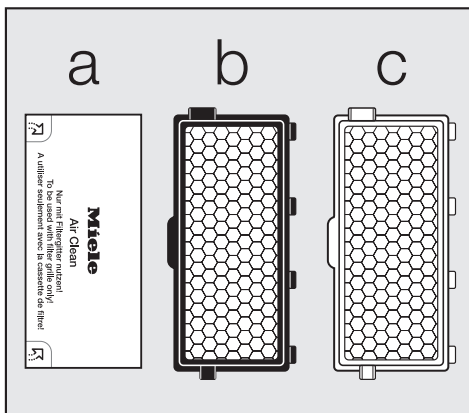

Replacing the Air Clean filter

Do not use more than one exhaust filter at a time.

- Open the dust compartment lid.
- Release the filter grille and raise it upwards. Grasp the used Air Clean filter by the clean, unsoiled section (see arrow) and take it out.

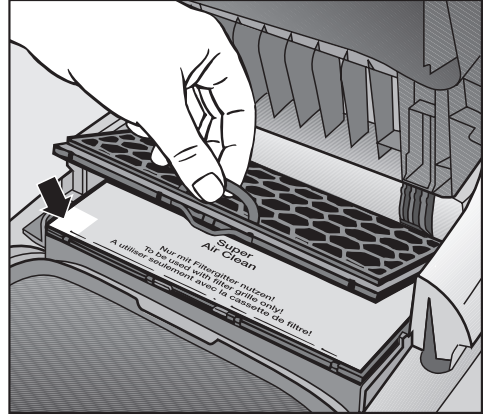

- Replace it with a new Air Clean filter.

If you wish to replace the Air Clean filter with an Active Air Clean filter or with an Active HEPA filter see "Replacing one type of filter with another".

- Close the filter grille.
- Close the dust compartment lid firmly. It should click into place.

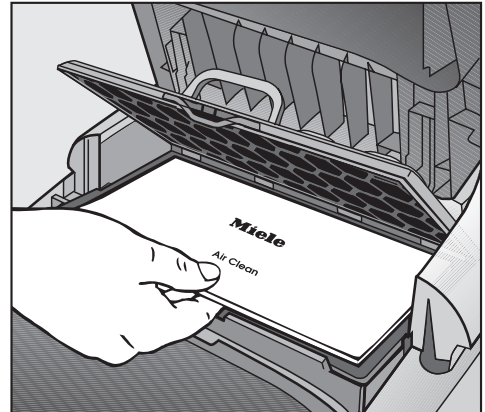

Maintenance and care

Replacing an Active Air Clean filter or an Active HEPA filter

Do not use more than one exhaust filter at a time.

- Open the dust compartment lid.
- Raise the filter and remove it.

- Replace with a new filter, and push it down into place.

If you wish to replace the Active Air Clean filter or the Active HEPA filter with an Air Clean filter see "Replacing one type of filter with another".

- Close the dust compartment lid firmly. It should click into place.

Re-setting the exhaust filter change indicator

If your vacuum cleaner is fitted with an exhaust filter change indicator, this needs to be re-set each time the filter is replaced. To do this the vacuum cleaner must be switched on.

- Press the reset button.

The exhaust filter change indicator goes out, and resets to zero.

The filter change indicator can only be reset by pressing the reset button after the light has come on. Pressing the button at any other time will have no effect.

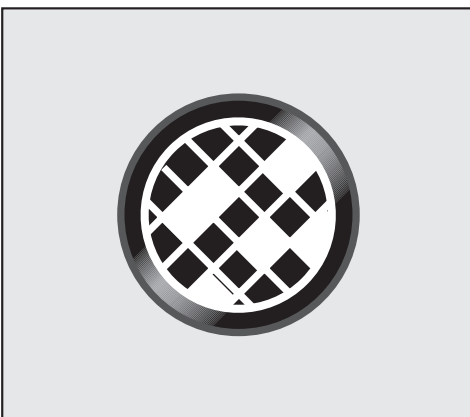
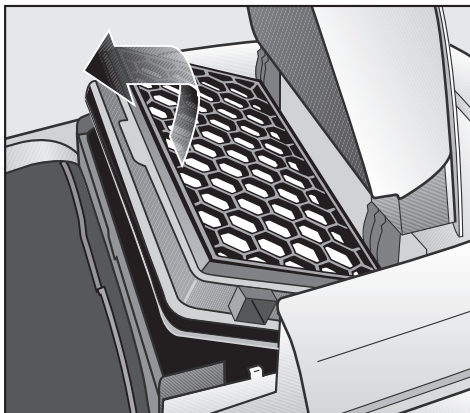

Replacing one type of filter with another

Depending on the model, your vacuum cleaner will be fitted as standard with one of the following exhaust filters:

- a** an Air Clean filter,
- b** an Active Air Clean filter SF-AAC 50 (black),
- c** an Active HEPA filter SF-AH 50 (blue).

Please note

1. If you wish to replace the Air Clean filter **a** with an Active Air Clean filter **b** or an Active HEPA filter **c**, it is essential that you remove the filter grille before fitting the new type of filter.

2. If you wish to replace the Active Air Clean filter **b** or the Active HEPA filter **c** with an Air Clean filter **a**, then it is essential that you also fit a filter grille *.

* Filter grille - see "Optional accessories".

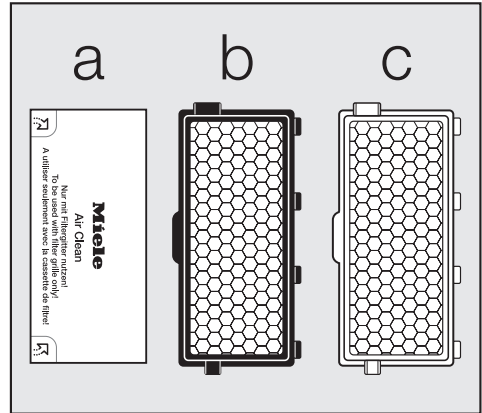

Do not use more than one exhaust filter at a time.

The exhaust filter indicator light (with reset button) that is fitted on certain models is designed to come on when the Active Air Clean or Active HEPA filter needs to be changed. The filter change indicator light is irrelevant if an Air Clean filter is being used, as long as it is replaced every time a new packet of Miele dustbags is started. The indicator light will go out when the reset button is pressed.

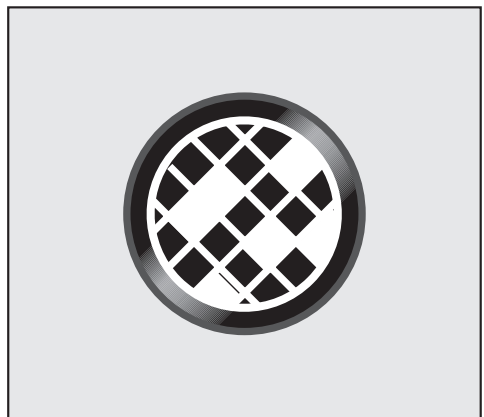

Maintenance and care

When to change the dust compartment filter (for motor protection)

Replace this filter every time you start a new packet of dustbags. A dust compartment filter is supplied with every packet of Miele dustbags.

How to change the dust compartment filter

- Open the dust compartment lid.
- Unclip the filter frame and remove the old filter. Hold it by the clean unsoiled section to remove it.
- Replace with a new dust compartment filter.
- Close the filter frame.
- Close the dust compartment lid firmly. It should click into place.

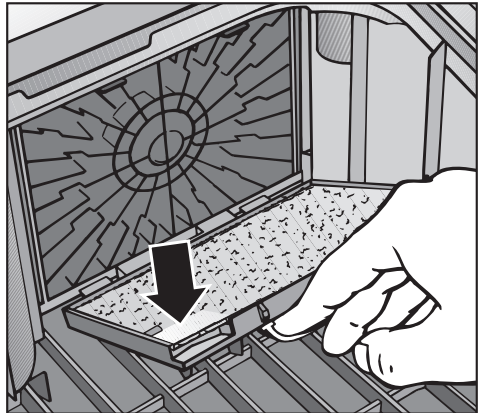

When to change the battery in the radio-operated handle

Approximately every 18 months.
One 3 V battery (CR 2032) is required.

The vacuum cleaner can still be used when the battery has run out or if there is no battery fitted.

- Switch the vacuum cleaner on using the On/Off foot control ①. The vacuum cleaner is ready to use (in stand-by mode).
- Press the re-set button for the exhaust filter change indicator.

The vacuum cleaner can continue to be used, but only at maximum power.

How to change the battery in the radio-operated handle

- ① Open the cover to the battery compartment on the handle, and remove the battery.
 - ② Remove the cover.
- Push the battery forwards to remove it. Then replace it with a new one, making sure the polarity is correct.
 - Close the battery compartment.
 - Dispose of the old battery responsibly.

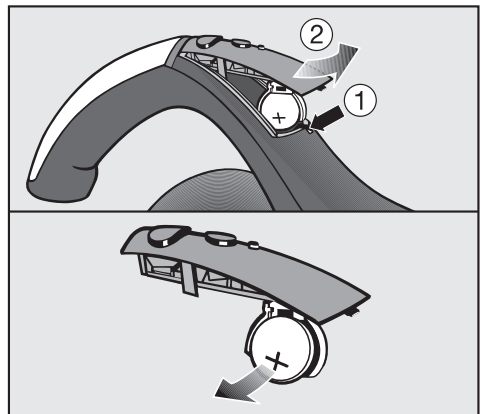

Maintenance and care

When to change the thread lifters

The thread lifters on the suction inlet to the floorhead and the upholstery nozzle can be replaced.

Check them from time to time and replace them if the pile has worn down.

To replace the thread lifters

- Use a suitable tool to remove them from the slots.
- Fit new thread lifters.

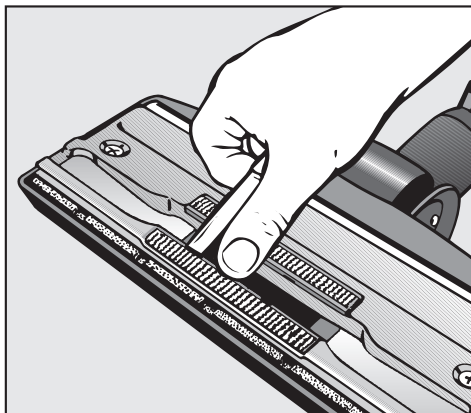

Upholstery nozzle, 190 mm

- Disengage the thread lifter unit at each side of the upholstery nozzle using a coin.
- Fit a new thread lifter unit and lock into position.

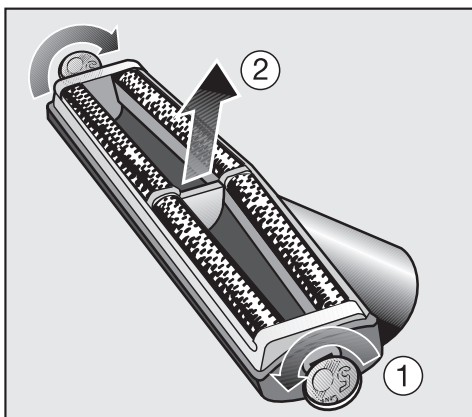



If threads or hair have wound round the bearing on the floorhead roller

- ① Release the bearing (with bayonet fitting) using a coin.
- ② Press the bearing out, and remove.
- ③ Take out the roller.

Remove any threads and hair, replace the roller and refit the bearing.

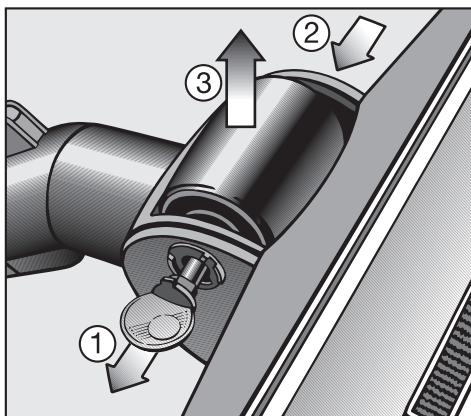
Spare parts are available from your Miele Vacuum Cleaner Specialist, from Miele (see back cover for contact details) or via the internet at www.miele-shop.com.



 Always disconnect the vacuum cleaner from the electricity supply for maintenance work and for cleaning. Switch off at the wall socket and remove the plug.

Vacuum cleaner and accessories

External surfaces of the vacuum cleaner and of the accessories can be cleaned with a dry or a slightly damp cloth, or with a proprietary cleaner suitable for plastic.

 Do not use abrasive cleaners, glass cleaners or all-purpose cleaners. Because of their chemical composition they could cause serious damage to plastic components.

Dust compartment

The dust compartment can, if necessary, be cleaned using a **dry** duster, brush or, if available, a second vacuum cleaner to vacuum the dust out.

 Do not let the vacuum cleaner get wet. If moisture gets into the appliance, there is a risk of electric shock.

Electrical connection

All work should be carried out by a suitably qualified and competent person in strict accordance with national and local safety regulations.

The voltage and rated load are given on the data plate located underneath the vacuum cleaner. Please ensure that these match the household mains supply. The fuse rating is quoted on the plug.

The appliance is supplied with a cable and moulded plug ready for connection to a 230V/50Hz a.c. single phase supply.

Test Marks.....Electrical safety
.....C-Tick Mark

Electrically suppressed
according to.....AS/NZS 1044

The vacuum cleaner switches off automatically.

On certain models, the overheating warning light also comes on.

A temperature limiter switches the vacuum cleaner off automatically if it gets too hot. Some models also have a warning light  which comes on to indicate that it has overheated.

This can occur if, for instance, large articles block the suction tube or when the filter bag is full or contains particles of fine dust. A heavily soiled exhaust or dust compartment filter can also be the cause of overheating. Switch the vacuum cleaner off immediately using the On/Off foot control . Disconnect from the electricity supply. Switch off at the wall socket and remove the plug.

After removing the cause, wait for approximately 20 - 30 minutes to allow the vacuum cleaner to cool down. It can then be switched on again.

After sales service

In the event of a fault that you cannot easily remedy, please contact

- your Miele Vacuum Cleaner Specialist

or

- Miele.

See back cover for Miele's contact details.



Optional accessories

It is important to observe the flooring manufacturer's cleaning and care instructions.

The following products and more can be ordered via the internet at www.miele-shop.com.



They can also be purchased from Miele or your local Miele Vacuum Cleaner Specialist.

Certain models are supplied as standard with one or more of the following accessories:

Floorheads / brushes

Electrobrush Electro Comfort (SEB 216-3)

Electrobrushes can only be used on models fitted with an Electrobrush socket.

The Electrobrush is particularly suitable for intensive vacuuming of carpets which are subject to hard wear. It is very effective at removing deep seated dirt and preventing areas of frequent use being trodden into a path.

Classic Allergotec floorhead

The level of cleanliness of the floor shows in a colour "traffic light" display when vacuuming. The Classic Allergotec floorhead is designed specially for the daily hygienic cleaning of all floor surfaces.

TurboBrush (STB 205-3)

The TurboBrush is particularly suitable for vacuuming cut-pile carpeting.

Hard Floor Brush (SBB 235-3)

Special brush for cleaning hard floors (slate, stone and tiles).

Other accessories

MicroSet (SMC 10)

This set is specially designed for cleaning small objects and difficult to reach areas (such as PC keyboards, stereo equipment, intricately carved furniture and ornaments, scale models, etc).

CarClean Set (SSC Plus)

The CarClean Set has been designed as an accessory for cleaning the interior of cars.

Mini TurboBrush

Intended for vacuuming upholstery, mattresses, car seats and other areas inaccessible to the standard TurboBrush.

Flexi universal brush (SUB 20)

For dusting books, shelves, etc.

Radiator brush (SHB 10)

For cleaning radiators, narrow shelves and crevices.

Mattress nozzle (SMD 10)

For cleaning upholstery, mattresses, cushions, curtains, covers etc.

Long crevice nozzle - 30 cm (SFD 10)

For cleaning in folds, crevices or corners.

Flexible crevice nozzle - 56 cm (SFD 20)

For cleaning difficult to access areas.

Upholstery nozzle 19 cm

Intended for vacuuming upholstery, mattresses and cushions.

Hygiene cap with active charcoal

This prevents dust and odours from escaping when the electro suction hose is removed for transportation or storage.

Hose adapter

For extending the suction hose by approximately 1.5 m.

Filters

Active Air Clean filter (SF-AAC 50)

Absorbs odours from the dustbag.

Active HEPA filter (SF-AH 50)

This filter is specially appropriate for allergy sufferers and users requiring exceptional standards of hygiene.

Filter grille

The filter grille is required if you wish to fit an Air Clean filter instead of an Active Air Clean filter or an Active HEPA filter.



Miele Australia Pty. Ltd.

ABN 96 005 635 398

Melbourne:

1 Gilbert Park Drive

Knoxfield, VIC 3180

Telephone: (03) 9764 7130

Fax: (03) 9764 7149

Sydney:

3 Skyline Place

Frenchs Forest, NSW 2086

Telephone: (02) 8977 4230

Fax: (02) 8977 4249

Brisbane:

39 Harvey Street North

Eagle Farm, QLD 4009

Telephone: 1800 798 578

Fax: 1800 799 578

Adelaide:

83-85 Sir Donald Bradman Drive

Hilton, SA 5033

Telephone: 1800 018 770

Fax: 1800 799 578

Perth:

205-207 Stirling Highway

Claremont, WA 6010

Telephone: 1800 094 872

Fax: 1800 799 578

www.miele.com.au

Miele New Zealand Limited

Unit L, 10-20 Sylvia Park Road

Mt. Wellington, 1060, Auckland

New Zealand

Telephone: 0800 264 353

Fax: 0800 463 453

www.miele.co.nz

Germany

Miele & Cie. KG

Carl-Miele-Straße 29

33332 Gütersloh

