



Refrigerator user manual

English

imagine the possibilities

Thank you for purchasing a Samsung product.
To receive a more complete service,
please register your product at
www.samsung.com/register

SAMSUNG

Free Standing Appliance

appl

Aust

features of your new refrigerator

KEY FEATURES OF YOUR NEW REFRIGERATOR(OPTIONAL)

Your Samsung Refrigerator comes equipped with many space-saving, innovative storage and energy-efficient features.

- **NEW WATER DISPENSER**
Flushed & isolated dispenser.
- **BLACK CLEAR LED DISPLAY**
With luxurious black window, you can see the neat & clear design.
- **HIGH-ENERGY EFFICIENCY**
Optimized power consumption.
- **DELUXE VEGETABLE BIN (COOL EVER ZONE)**
Optimized humidity control keeps vegetables & fruits fresh longer.
- **DOOR ALARM**
A helpful beeper alerts you if door is ajar.

CE Notice (European Union)

This product has been determined to be in compliance with the Low Voltage Directive (2006/95/EC), the Electromagnetic Compatibility Directive (2004/108/EC) and Energy efficiency Directive (96/57/EC) of the European Union.



For easy future reference write the model and serial number down. You will find your model number on the left hand side wall of the refrigerator.

Model # _____

Serial # _____



apple

Aust



safety information

SAFETY INFORMATION









- Before operating the appliance, please read this manual thoroughly and retain it for your reference.
- Use this appliance only for its intended purpose as described in this instruction manual. This appliance is not intended for use by persons (including children) with reduced physical, sensory or mental capabilities, or lack of experience and knowledge, unless they have been given supervision or instruction concerning use of the appliance by a person responsible for their safety.
- Because these following operating instructions cover various models (electronic control type, mechanical control type) the characteristics of your refrigerator may differ slightly from those described in this manual.

CAUTION/WARNING SYMBOLS USED

	Indicates that a danger of death or serious injury exists.
	Indicates that a risk of personal injury or material damage exists.

OTHER SYMBOLS USED

	Represents something you must NOT do.
	Represents something you must NOT disassemble.
	Represents something you must NOT touch.
	Represents something you must follow.
	Indicates that you must disconnect the power plug from the socket.
	Represents a ground is needed to prevent electric shock.
	It is recommended that this symbol be handled by service man.

**These warning signs are here to prevent injury to you and others.
Please follow them explicitly.
After reading this section, keep it in a safe place for future reference.**

**Contains fluorinated greenhouse gases covered by the Kyoto Protocol.
Hermetically sealed system.**

Do not vent gases into the atmosphere.

Refrigerant type: R-134a

Quantity: 0.16Kg

Global Warming Potential (GWP) = 1300



safety information

SEVERE WARNING SIGNS FOR DISPOSAL



- When disposing of this or other refrigerator/s, remove the door/door seals, door latch so that small children or animals cannot become trapped inside. Children should be supervised to ensure that they do not play with the appliance.
- Please dispose of the packaging material for this product in an environmentally friendly manner.
- Leave the shelves in place so that children may not easily climb inside. Ensure that none of the pipes on the back of the appliance are damaged prior to disposal.
- R600a or R134a is used as a refrigerant. Check the compressor label on the rear of the appliance or the rating label inside the fridge to see which refrigerant is used for your refrigerator. When this product contains flammable gas (Refrigerant R600a), contact your local authority in regard to safe disposal of this product. Cyclopentane is used as an insulation blowing gas. The gases in insulation material require special disposal procedure. Please contact your local authorities in regard to the environmentally safe disposal of this product. Ensure that none of the pipes on the back of the appliances are damaged prior to disposal. The pipes shall be broken in the open space.

SEVERE WARNING SIGNS FOR INSTALLATION



- This refrigerator must be properly installed and located in accordance with the manual before it is used.
- Do not install the refrigerator in a damp place or place where it may come in contact with water.
 - Deteriorated insulation of electrical parts may cause an electric shock or fire.
- Do not place this refrigerator in direct sunlight or expose to the heat from stoves, room heaters or other appliance.
- The refrigerator must be grounded.
 - You must ground the refrigerator to prevent any power leakages or electric shocks caused by current leakage from the refrigerator.
- Never use gas pipes, telephone lines or other potential lightning rods as ground.
 - Improper use of the ground plug can result in electric shock.
- Do not plug several appliances into the same multiple power board. The refrigerator should always be plugged into its own individual electrical which has a voltage rating that matched the rating plate.
 - This provides the best performance and also prevents overloading house wiring circuits, which could cause a fire hazard from overheated wires.
- If the wall socket is loose, do not insert the power plug.
 - There is a risk of electric shock or fire.
- Connect the power plug in proper position with the cord hanging down.
 - If you connect the power plug upside down, wire can get cut off and cause fire or electric shock.

- Do not use a cord that shows cracks or abrasion damage along its length or at either end.
- If the power cord is damaged, have it replaced immediately by the manufacturer or its service agent.
- Do not bend the power cord excessively or place heavy articles on it.
- When moving the refrigerator, be careful not to roll over or damage the power cord.
 - This constitutes a fire hazard.
- Make sure that the power plug is not squashed or damaged by the back of the refrigerator.
- Never unplug your refrigerator by pulling on the power cord. Always grip plug firmly and pull straight out from the outlet.
 - Damage to the cord may cause a short-circuit, fire and/or electric shock.
- If the power cord is damaged, have it replaced immediately by the manufacturer or its service agent.
- Keep the packing materials out of reach of children.
 - There is a risk of death from suffocation if children put them on their head.
- The appliance must be positioned so that the plug is accessible after installation.

CAUTION SIGNS FOR INSTALLATION



- Allow sufficient space to install the refrigerator on a flat surface.
 - If your refrigerator is not level, the internal cooling system may not work correctly.
- Keep ventilation opening in the appliance enclosure or mounting structure clear of obstruction.
- Allow the appliance to stand for 2 hours after installation.

SEVERE WARNING SIGNS FOR USING



- Do not insert the power plug with wet hands.
- Do not store articles on the top of the appliance.
 - When you open or close the door, the articles may fall and cause personal injury and/or material damage.
- Do not put a container filled with water on the refrigerator.
 - If spilled, there is a risk of fire or electric shock.
- Children should be supervised to ensure that they do not play with the appliance.
- Do not let children hang on the door. If not, a serious injury may occur.
- There is a Risk of children entrapment. Do not let children enter inside of the refrigerator.
- Do not insert your hands into the bottom area under the appliance.
 - Any sharp edges may cause personal injury.
- Do not let children step on drawer's cover.
 - It can be broken and cause slip accident.

- Do not overfill the refrigerator with food.
 - When you open the door, an item may fall out and cause personal injury or material damage.
- Do not touch the inside walls of the freezer or products stored in the freezer with wet hands.
 - This may cause frostbite.
- Bottles should be stored tightly together so that they do not fall out.
- Never put fingers or other objects into the dispenser hole.
 - It may cause personal injury or material damage.
- Do not store volatile or flammable substances in the refrigerator.
 - The storage of benzene, thinner, alcohol, ether, LP gas and other such products may cause explosions.
- This product is intended only for the storage of food in a domestic environment.
- Do not store pharmaceuticals products, scientific materials or temperature-sensitive products in the refrigerator.
 - Products that require strict temperature controls must not be stored in the refrigerator.
- Do not place or use electrical appliance inside the refrigerator/freezer, unless they are of a type recommended by the manufacturer.
- If you smell pharmaceutical or smoke, pull out power plug immediately and contact your Samsung Electronics service center.
- Do not disassemble or repair the refrigerator by yourself.
 - You run risk of causing a fire, malfunction and/or personal injury.
- If any dust or water is in Refrigerator, pull out power plug and contact your Samsung Electronics service center.
 - Otherwise there is a risk of fire.
- If gas leak is detected, avoid any naked flames or potential sources of ignition and air the room in which the appliance is standing for several minutes.
- Do not use mechanical devices or any other means to accelerate the defrosting process, other than those recommended by the manufacturer.
- Do not damage the refrigerant circuit.
- Pull the power plug out of the socket before changing the interior lamps of the refrigerator.
 - Otherwise, there is a risk of electric shock.
- If you experience difficulty when changing the light, contact service agents.
- If the products equipped with LED Lamp, do not disassemble Lamp Cover and LED Lamp by yourself.
 - Please contact your service agents.
- Use only the LED Lamps provided by manufacturer or service agents.

CAUTION SIGNS FOR USING



- If the refrigerator is disconnected from the power supply, you should wait for at least five minutes before plugging it back.
- If you have a long vacation planned or the refrigerator is not to be used for a long period of time, you must empty the refrigerator and pull out the power plug.
 - Deterioration in the insulation may cause fire.
- Do not re-freeze frozen foods that have thawed completely.
- Wipe excess moisture from the inside and leave the doors open.
 - Otherwise, odor and mold may develop.
- When the refrigerator got wet by water, pull out the power plug and contact your Samsung Electronics service center.
- Allow the appliance to stand for 2 hours after installation.
- To get Best performance of product,
 - Do not place foods too closely in front of the vents at the rear of the appliance as it can obstruct free air circulation in the freezer compartment.
 - Wrap the food up properly or place it in airtight containers before put it into the fridge or freezer.
 - Do not put any newly introduced food for freezing near to already food.
- Do not place carbonated or fizzy drinks in the freezer compartment. Do not put bottles or glass containers in the freezer.
 - When the contents freeze, the glass may break and cause personal injury.
- Please observe maximum storage times and expiry dates of frozen goods.
- There is no need to disconnect the refrigerator from the power supply if you will be away for less than three weeks. But, Remove all the food if you are going away for the three weeks or more. Unplug the refrigerator and clean it, rinse and dry.
- Fill water tank, ice tray, water cubes only with potable water.

safety information

CAUTION SIGNS FOR CLEANING



- Remove any foreign matter or dust from the power plug pins. But do not use a wet or damp cloth when cleaning the plug, remove any foreign material or dust from the power plug pins.
 - Otherwise there is a risk of fire or electric shock.
- Unplug the refrigerator before cleaning and making repairs.
- Do not directly spray water inside or outside the refrigerator.
 - There is a risk of fire or electric shock.
- Do not place or use electrical appliance inside the refrigerator/freezer, unless they are of a type recommended by the manufacturer.
- Do not spray inflammable gas near the refrigerator.
 - There is a risk of explosion or fire.

ADDITIONAL TIPS FOR PROPER USAGE



- In the event of a power failure, call the local office of your Electricity Company and ask how long it is going to last.
 - Most power failures that are corrected in an hour or two will not affect your refrigerator temperatures. However, you should minimize the number of door openings while the power is off.
 - But Should the power failure last more than 24 hours, remove all frozen food.
- If the key is provided with refrigerator, the keys should be kept out of the reach of children and not in vicinity of the appliance.
- The appliance might not operate consistently (possibility of defrosting of contents or temperature becoming too warm in the frozen food compartment) when sited for an extended period of time below the cold end of the range of temperatures for which the refrigerating appliance is designed.
- Do not store food which spoils easily at low temperature, such as bananas, melons.
- Your appliance is frost free, which means there is no need to manually defrost your appliance, as this will be carried out automatically.
- Temperature rising during the defrost can comply with ISO requirement. But If you want to prevent an undue rise in the temperature of the frozen food while defrosting the appliance, please wrap the frozen food in several layers of newspaper.
- Any increase in temperature of frozen food during defrosting can shorten its storage life.

contents

SETTING UP YOUR REFRIGERATOR

10

- 10 Getting ready to install the refrigerator
- 11 Levelling the refrigerator
- 12 Installing and Disassembling the door handle
- 13 Setting up the refrigerator

OPERATING THE SAMSUNG REFRIGERATOR

14

- 14 Using the control panel
- 15 Controlling the temperature (electronic control)
- 16 Controlling the temperature (dial control type)
- 17 Making ice
- 18 Using water dispenser
- 20 Storing food
- 22 Removing the refrigerator accessories
- 23 Cleaning the refrigerator
- 25 Cleaning the water Dispenser
- 26 Replacing the interior light

TROUBLESHOOTING

27

CIRCUIT DIAGRAM

28



setting up your refrigerator

GETTING READY TO INSTALL THE REFRIGERATOR

Congratulations on the purchase of your Samsung Refrigerator. We hope you will enjoy the many state-of-the-art features and efficiencies that this new appliance has to offer.



- This refrigerator must be properly installed and located in accordance with the manual before it is used.
- Use this appliance only for its intended purpose as described in this instruction manual.
- We strongly recommend that any servicing be performed by a qualified individual.
- Please dispose of the packaging material for this product in an environmentally friendly manner.
- Pull the power plug out of the socket before changing the interior light of the refrigerator.
 - Otherwise, there is a risk of electric shock.

Selecting the best location for the refrigerator

- Select a location without direct exposure to sunlight.
- Select a location with level (or nearly level) flooring.
- Select a location with enough space for the refrigerator doors to open easily.
- Allow sufficient space to install the refrigerator on a flat surface.
 - If your refrigerator is not level, the internal cooling system may not work correctly.
 - Overall space required in use. Refer to drawing and dimension as below.

GETTING READY TO INSTALL THE REFRIGERATOR

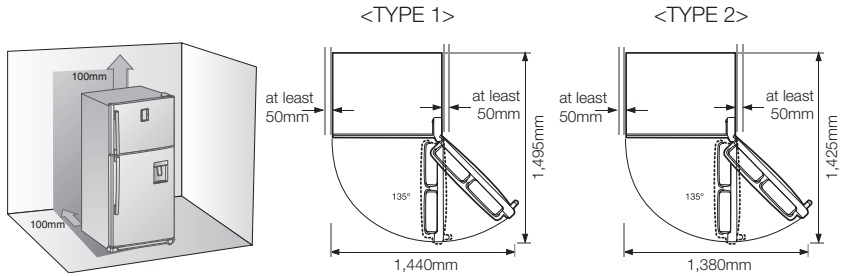

- Allow clearance to the right, left, back and top when installing. This will help reduce power consumption and keep your energy bills lower.
- Do not install the refrigerator where the temperature will go below 10°C.



When installing, servicing, or cleaning behind the refrigerator, be sure to pull the unit straight out and push back in straight after finishing. Also, make sure your floor supports the full-load refrigerator. Otherwise, it may cause floor damage.



- Please tie up the extra length of the power cord at the back of the refrigerator so as not to be touched on the floor preventing the power cord from being crushed by the rollers upon relocation.

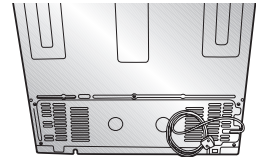

LEVELLING THE REFRIGERATOR

If the front of the appliance is slightly higher than the rear, the door can be opened and closed more easily.

case 1) The appliance tilts down to the left.

- Turn the left adjusting leg in the direction of the arrow until the appliance is level.

case 2) The appliance tilts down to the right.

- Turn the right adjusting leg in the direction of the arrow until the appliance is level.

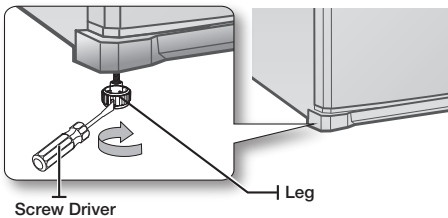

<case 1>

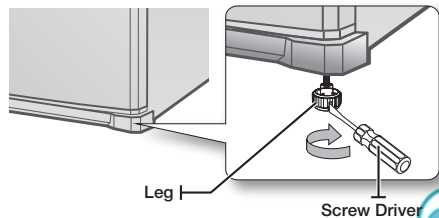

<case 2>



setting up your refrigerator

INSTALLING AND DISASSEMBLING THE DOOR HANDLE

Installing the Door Handle

1. Match the Handle Locking Tabs installed on the left hand side of the door and the handle inserts.
2. Fix the handle by pulling it down or tapping it lightly with a tool like a rubber hammer.
3. Check whether the locking tabs inside the handle are assembled by pulling it up and down.

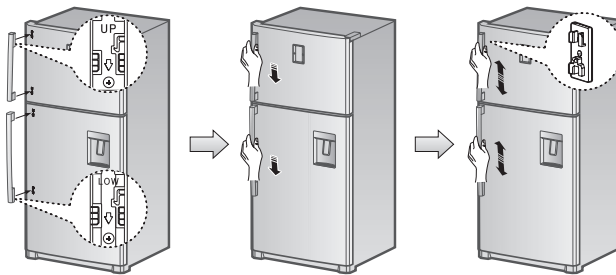

Disassembling the Door Handle

1. Separate the locking tabs by tapping the lower part of the handle with a tool like a rubber hammer.
2. Pull the handle up to detach the locking tabs from the handle inserts and separate each other.

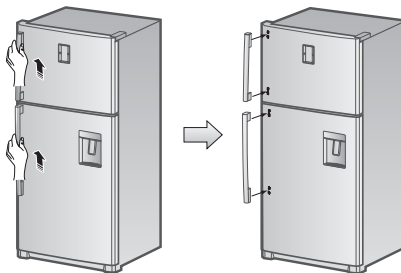

There is a possibility of the handle detachment when excessive force is applied to the handle during relocation of the refrigerator, so do not grab the handle.

SETTING UP THE REFRIGERATOR

Now that you have your new refrigerator installed and in place, you are ready to set up and enjoy the full features and functions of the appliance.

By completing the following steps, your refrigerator should be fully operational.

If not, first check the power supply and electricity source or try the troubleshooting section at the back of this user guide. If you have any further questions, contact your Samsung Electronics service center.

1. Place the refrigerator in an appropriate location with reasonable clearance between the wall and the refrigerator. Refer to installation instructions in this manual.
2. Once the refrigerator is plugged in, make sure the interior light comes on when you open the doors.
3. Set the temperature control to the coldest temperature and wait for an hour. The freezer should get slightly chilled and the motor should run smoothly.
4. After powering the refrigerator, it will take a few hours to reach the appropriate temperature. Once the refrigerator temperature is sufficiently cool, you can store food and drink in the refrigerator.



operating the SAMSUNG refrigerator

USING THE CONTROL PANEL (ELECTRONIC CONTROL TYPE)

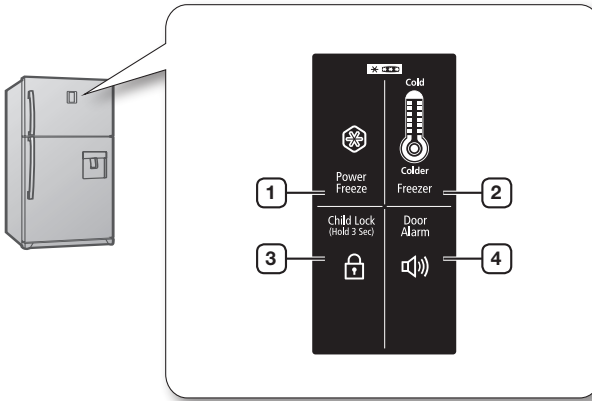

<p>1 POWER FREEZE</p>	<p>Speeds up the time needed to freeze products in the freezer. This can be helpful if you need to quickly freeze items that spoil easily or if the temperature in the freezer has warmed dramatically (For example, if the door was left open). When you have enough, just press the button again to cancel the “Power Freeze” mode. When you use this function, the energy consumption will increase. This function must be activated before putting large amount of food stuff in the freezer compartment at least 24 hours before.</p>
<p>2 FREEZER</p>	<p>Press the Freezer button to set the Freezer to your desired temperature, you can set the temperature between -14°C and -25°C.</p>
<p>3 CHILD LOCK</p>	<p>By pressing the child lock button for 3 seconds, all buttons will be locked. To cancel this function, press the child lock button again for 3 seconds again.</p>
<p>4 DOOR ALARM</p>	<p>When you press the Door alarm button, Door alarm icon will light up. The alarm will go off after a certain period of time (about 2 minutes) when the refrigerator door is kept open. if you want to turn off the Alarm, press the button again.</p>

CONTROLLING THE TEMPERATURE (ELECTRONIC CONTROL TYPE)

CONTROLLING THE FREEZER TEMPERATURE

The freezer temperature can be set between -14°C and -25°C to suit your particular needs. Press the Freezer button repeatedly until the desired temperature is shown in the temperature display. Keep in mind that foods like ice cream may melt at -14°C . The temperature display will move sequentially from -14°C and -25°C . When the display reaches -14°C , it will begin again at -25°C .

Five seconds after the new temperature is set the display will again show the actual current freezer temperature. However, this number will change as the Freezer adjusts to the new temperature.

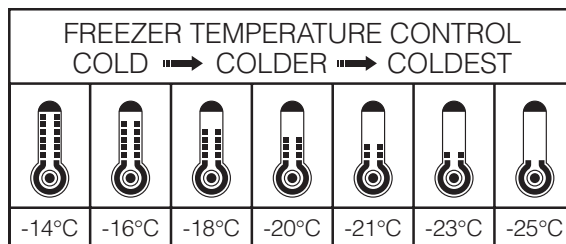

CONTROLLING THE FRIDGE TEMPERATURE

The refrigerator temperature can be set between 5°C and 1°C to suit your particular need. Turn the Fridge lever clockwise or counter clockwise until the desired temperature is shown in the cover damper.

When storing large quantities of food to be refrigerated or temperature is not cold enough, Adjust the temperature control to the "COLDER" position.

When using MID range, adjust the temperature control to the halfway position between COLDER and COLD.

When the food refrigerated is frozen, or there is a small quantity of food, adjust the temperature control to the COLD position.

If you are going on a long vacation or business trip or you do not need to use the refrigerator, adjust the temperature control to the "VACATION" position. The refrigerator is switched off but the freezer remains on.

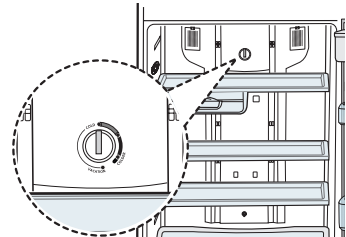

CAUTION

You must empty the refrigerator before adjusting the Vacation position.



The temperature of the freezer or the refrigerator may rise from opening the doors too frequently, or if a large amount of warm or hot food is placed in either side. This may cause the digital display to blink. Once the freezer and refrigerator return to their normal set temperatures the blinking will stop. If the blinking continues, you may need to "reset" the refrigerator. Try unplugging the appliance, wait about 10 minutes and then plug back in.



app

operating the SAMSUNG refrigerator

CONTROLLING THE TEMPERATURE (DIAL CONTROL TYPE)

-Freezer

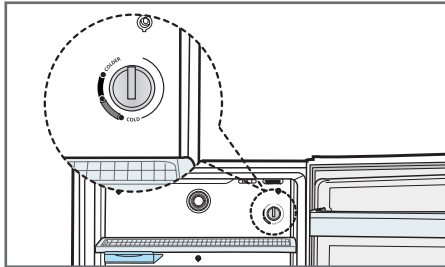

COLDER : When storing large quantities of foods to be frozen, or to produce ice quickly.

- Adjust the temperature control to the "COLDER" position.

COLDER to COLD : When using MID range.

- Adjust the temperature control to the halfway position between COLDER and COLD.

COLD : When storing a small quantity of food to be frozen.

- Adjust the temperature control to the COLD position.
- If you need to freeze large amount of food stuff, set the temperature of freezer compartment as the coldest temperature at least 24 hours before.

-Fridge

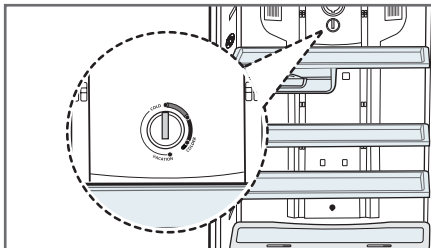

Vacation

- If you are going on a long vacation or business trip or you do not need to use the refrigerator, adjust the temperature control to the "VACATION" position.
- The refrigerator is switched off but the freezer remains on.



You must empty the refrigerator before adjusting the vacation position.

COLDER : When storing large quantities of food to be refrigerated or temperature is not cold enough.

- Adjust the temperature control to the "COLDER" position.

COLDER to COLD : When using MID range.

- Adjust the temperature control to the halfway position between COLDER and COLD.

COLD : When the food refrigerated is frozen, or there is a small quantity of food.

- Adjust the temperature control to the COLD position.

MAKING ICE

- TWIST ICE MAKER MODEL

Making ice cubes

Remove the ice cube tray by pulling it towards you. Fill the tray with water up to the maximum water level marked on the rear of the tray.

Slide the tray back into the holder, taking care not to spill the water.

Wait until the ice cubes are formed.

Freezing time :

It is recommended that you wait for about one hour with the temperature set to Power Freeze for the ice cubes to form.

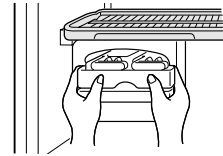
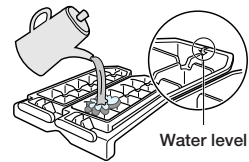

Removing the ice cubes

Make sure that the ice cube storage bin is in place under the ice cube tray. If not, slide it into place.

Twist one of the levers firmly in the clockwise direction until the tray twists slightly.

Result : The ice cubes fall into the storage bin.

Repeat Step 2 for the other half of the tray, if necessary.

Remove the storage bin by:

- Lifting it slightly
- Pulling it towards you

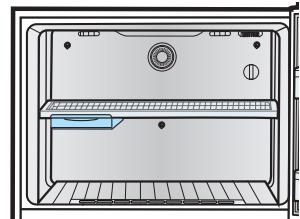

- REMOVABLE ICE TRAY MODEL

Making ice cubes

Remove the ice cube tray by pulling it towards you.

Fill the tray with water up to the maximum water level marked on the rear of the tray.

Slide the tray back into the holder, taking care not to spill the water.

Removing the ice cubes

To remove ice cubes, hold the tray at its ends and twist gently.

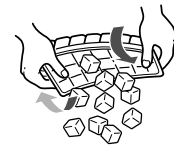
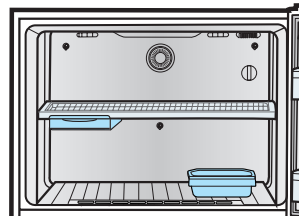

Danger of explosion

- Glass bottles containing liquids that can freeze should never be stored in the freezer as the glass will explode when the contents freeze.



To get more space, you can remove the TWIST ICE MAKER, ICE STORAGE BIN and ICE CUBE TRAY. It does not affect thermal and mechanical characteristics. A declared storage volume of frozen food storage compartment is calculated with these drawers removed.



operating the SAMSUNG refrigerator

USING WATER DISPENSER (OPTIONAL)

With the water dispenser, you can obtain chilled water easily without opening the refrigerator door.

Lift up and pull out the water tank.

- Hold the handgrips on both sides to lift out the water tank.
- Clean the inside of water tank before using it for the first time.

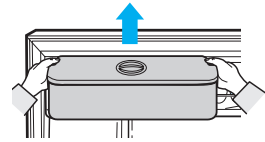

Fill the water tank with water, ensuring that it is in a stable position, allowing for the extended water supply outlet.

- Fill with water up to 2.8ℓ. If it is filled higher than this, it may overflow when the lid is closed.
- It is impossible to fill the tank with water while it is positioned in the refrigerator.

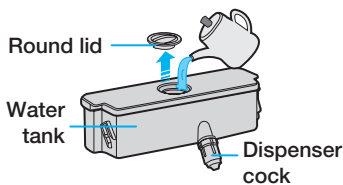

Method 1.

Fill the water lifting the round lid in the arrow direction to open.

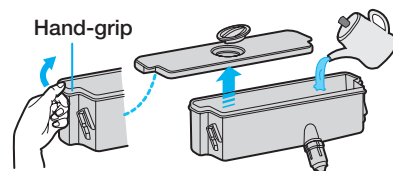

Method 2.

Please fill the water after holding and lifting the large lid to open it.

Close the refrigerator door after fitting the water tank.

- Confirm that the dispenser cock is outside after closing the door.



Fix water tank to the fridge door tightly.
If not, water tank may not operate correctly.
Do not use the refrigerator without the water tank.
If not, it may cause an efficiency problem.

Place a glass underneath the water outlet and push gently against the dispenser lever with your glass. Make sure the glass is in line with the dispenser to prevent the water from bouncing out.

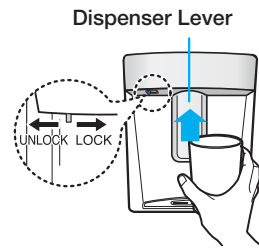

Check that the locking device is set to "unlock".
Water can only be dispensed on this setting.

operating the SAMSUNG refrigerator



STORING FOOD

The Samsung Refrigerator has been designed to provide you with maximum space saving features and functions. Here are some of the customized compartments we have created to keep your food fresher, longer. Remember, in order to prevent odour penetration to the ice, stored food should be wrapped securely and as airtight as possible.

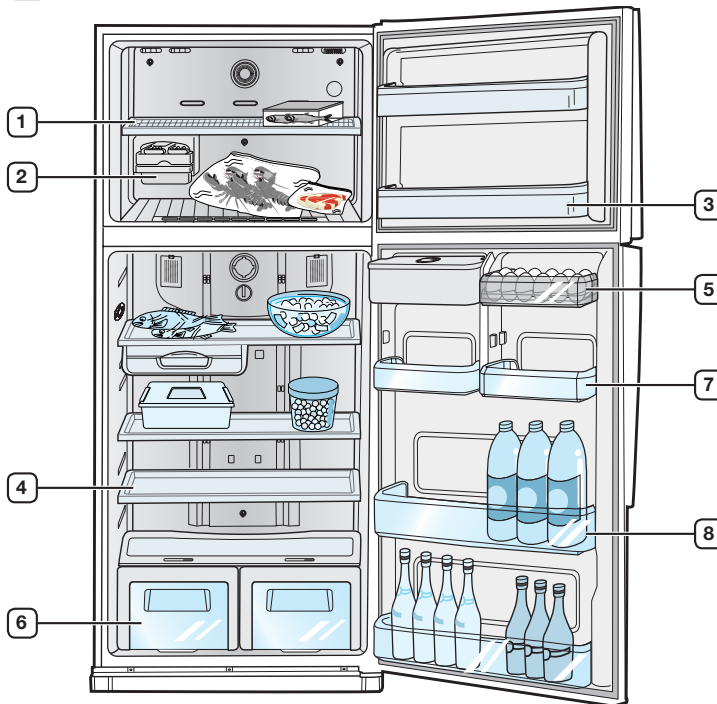
 Items may differ slightly from the below model.







Storing Food in the Freezer

1 SHELVES	Can be used to store all types of frozen food.	
2 ICE CUBE (Optional)	Can be used to store ice.	
3 FREEZER GUARD	Can be used for small packages of frozen food.	

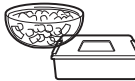

Glass bottles containing liquids that can freeze should never be stored in the freezer as the glass may explode when the contents freeze.

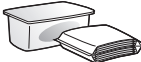
Storing Food in the Fridge

4 SHELVES	Designed to be crack-resistant. They can be used to store all types of food and drinks. Circular marks on the glass surface are a normal phenomenon and can usually be wiped clean with a damp cloth.	
5 EGG TRAY	Best place to keep eggs. Place the EGG TRAY on the shelf for easy access.	
6 FRUIT & VEGETABLE DRAWER (Optional)	Used to preserve the freshness of your stored vegetables and fruits. It has been specifically designed to control the level of humidity within the drawer. A Big box or Two drawer box is offered according to your choice.	
7 DAIRY GUARD	Can be used to store smaller dairy items like butter or margarine, yogurt or cream-cheese bricks.	
8 BOTTLE GUARD	Designed to handle large, bulky items such as gallons of milk or other large bottles and containers.	



Bottles should be stored tightly together so that they do not tip and fall out when the refrigerator door is opened.



- If you plan to go away for a significant time, empty the refrigerator and turn it off. Wipe the excess moisture from the inside of the appliance and leave the doors open. This helps keep odour and mold from developing.
- If the refrigerator is not to be used for a long period of time, pull out the power plug.

operating the SAMSUNG refrigerator

REMOVING THE REFRIGERATOR ACCESSORIES

1. Pull out the ice tray first and then lift up the front part of freezer shelf and pull it out forward.

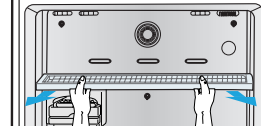

2. Lift up the fridge shelf and pull it forward.

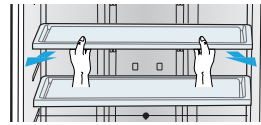

3. Lift up the vegetable bin lid and pull it forward.
Pull out vegetable box while lifting it up pulling forward after it has reached the middle of the slide.

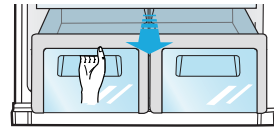

4. Lift up and pull out the water tank (optional) as shown in the diagram.

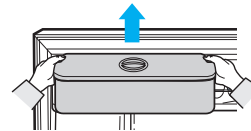

5. Pull it out while pressing the end of the sill on the low temperature catalyzing deodorizer.

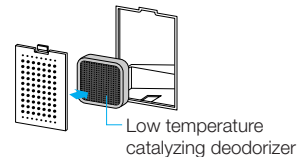

6. Lift up and pull out the door guards.

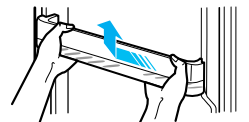

Before removing any accessories, make sure that no food is in the way.
When possible, remove the food altogether to reduce the risk of accidents.

CLEANING THE REFRIGERATOR

Caring for your Samsung Refrigerator prolongs the life of your appliance and helps keep it odor and germ-free.

Cleaning the Interior

Clean the inside walls and accessories with a mild detergent and then wipe dry with a soft cloth. You can remove the drawers and shelves for a more thorough cleaning. Just make sure to dry them before putting them back into place.

Cleaning the Exterior

Wipe the digital panel and display panel with a clean, soft cloth. Spray water onto the cleaning cloth instead of spraying directly on the surface of the refrigerator. This helps ensure an even distribution of moisture to the surface. The doors, handles and cabinet surfaces should be cleaned with a mild detergent and then wiped dry with a soft cloth. To keep your appliance looking its best, the exterior should be polished once or twice a year.

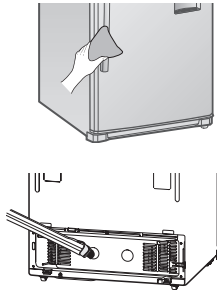

WARNING

Do not use Benzene, Thinner or Clorox™ for cleaning. They may damage the surface of the appliance and can create a risk of fire.

Cleaning the Rubber door seals

If the rubber door seals are dirty the doors may not close properly, and the refrigerator will not operate efficiently. Keep the door seals free of grit or grime by cleaning the doors with a mild detergent and damp cloth. Wipe dry with a clean, soft cloth.

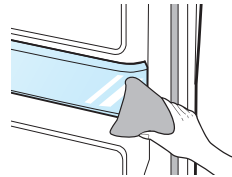

CAUTION

Do not spray the refrigerator with water while it is plugged in, as it may cause an electric shock. Do not clean the refrigerator with benzene, thinner or car detergent for risk of fire.



app

Cleaning the Deodorizer

In case of food smells in the fridge, Clean the low temperature catalyzing deodorizer.

After disassembling, dip into clean water and leave to dry completely in sunlight before reinserting.

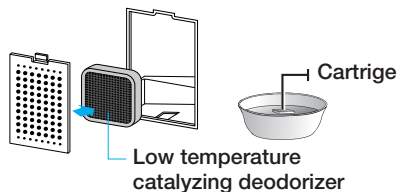

If the cartridge dries in a confined (or humid) area, there may be an odour to the cartridge. If this occurs, re-clean and allow to dry in a well-ventilated area.

Cleaning behind the Refrigerator

To keep cords and exposed parts free of dust and dirt accumulation, vacuum behind the appliance once or twice a year.



Do not remove the back cover. There can be a risk of electric shock.

CLEANING THE WATER DISPENSER

1. Separate the large lid from the water tank after pulling it out. It can be separated from water tank by pulling up the hand-grip.

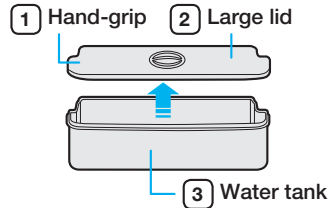

2. Separate the water tank from water spout.
 - Hold the upper part of Dispenser cock and unscrew it in arrow direction.

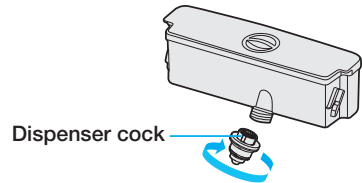

3. After washing the water tank and lid with dishwashing detergent, rinse them with water.

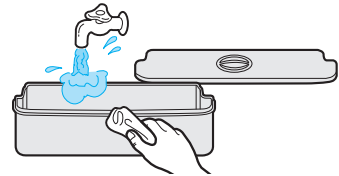

4. Clean the Dispenser cock with a soft brush.
 - Disassemble and clean occasionally.

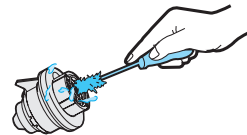

5. How to use the Dispenser tray.
 - Frequently empty water collected in the tray dispenser and wipe it out with dry clothe.

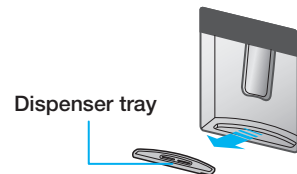

CAUTION

- Do not store hot water in the water tank.
- Be careful not to damage or lose the Dispenser cock.
- Do not let children mishandle the Dispenser cock. It may cause water overflow.



app

operating the SAMSUNG refrigerator

REPLACING THE INTERIOR LIGHT



Always unplug the appliance when replacing the refrigerator light. This eliminates the danger of electric shock.

Fridge lamp

1. Remove the indoor lamp cover by using a (+) driver, fit the front part of indoor lamp cover into the groove and then fit the rear part.
2. Turn(ccw) the indoor lamp to remove and replace it with a new one.
3. After fitting the front part of the indoor lamp cover, fit the rear sill area and then re-fit the screw.

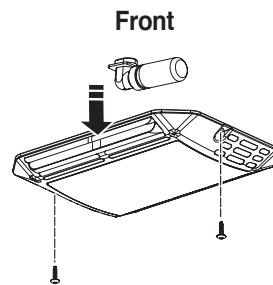

Freezer lamp (Optional)

1. Remove the screws.
Unlock the sills and pull the Lamp cover down to remove it.
2. Turn(ccw) the indoor lamp, remove it and replace it with a new one.

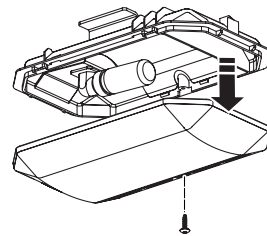

* If you have difficulties in replacing and purchasing parts, contact the nearest Samsung Electronics Service Center.

troubleshooting

PROBLEM	SOLUTION
The appliance is not operating at all or the temperature is too high.	<ul style="list-style-type: none"> • Check that the power plug is correctly connected. • Is the temperature control on the front panel correctly set? • Does sun shine on the appliance or are there heat sources nearby? • Is the back of the appliance too near to the wall?
The food in the refrigerator is frozen.	<ul style="list-style-type: none"> • Is the temperature control on the front panel set to the coldest temperature? • Is the surrounding temperature too low? • Did you store the food with a high water content in the coldest part of the fridge?
There are unusual noises.	<ul style="list-style-type: none"> • Check that the appliance is installed on a stable, level floor. • Is the back of the appliance too near to the wall? • Have any foreign objects fallen behind or under the appliance? • Is the noise coming from the compressor in the appliance? • A ticking sound may be heard inside the appliance; this is normal. This sound occurs when the various accessories contract or expand.
The front corners and sides of the appliance are warm and condensation starts to form.	<ul style="list-style-type: none"> • Heat-proof pipes are installed in the front corners of the appliance to prevent condensation from forming. When the surrounding temperature rises, this may not always be effective. However, this is not abnormal. • In very humid weather, condensation may form on the outer surface of the appliance when the moisture in the air comes into contact with the cool surface of the appliance.
You can hear a liquid bubbling in the appliance.	<ul style="list-style-type: none"> • This is the refrigerant, which cools the inside of the appliance.
There is a bad smell inside the appliance.	<ul style="list-style-type: none"> • Has a food item spoiled? • Make sure that strong smelling food (for example, fish) is wrapped so that it is airtight. • Clean out your freezer periodically and throw away any spoiled or suspect food.
There is a layer of frost on the appliance walls.	<ul style="list-style-type: none"> • Are the air outlet vents blocked by food stored inside the refrigerator. • Space the food out as much as possible to improve ventilation. • Is the door fully closed?
Condensation forms on the inside wall of the appliance and around vegetables.	<ul style="list-style-type: none"> • Food with a high water content is stored uncovered with a high humidity level or the door has been left open for a long time. • Store the food with a cover or in sealed containers.



circuit diagram

ELECTRONIC CONTROL TYPE 1

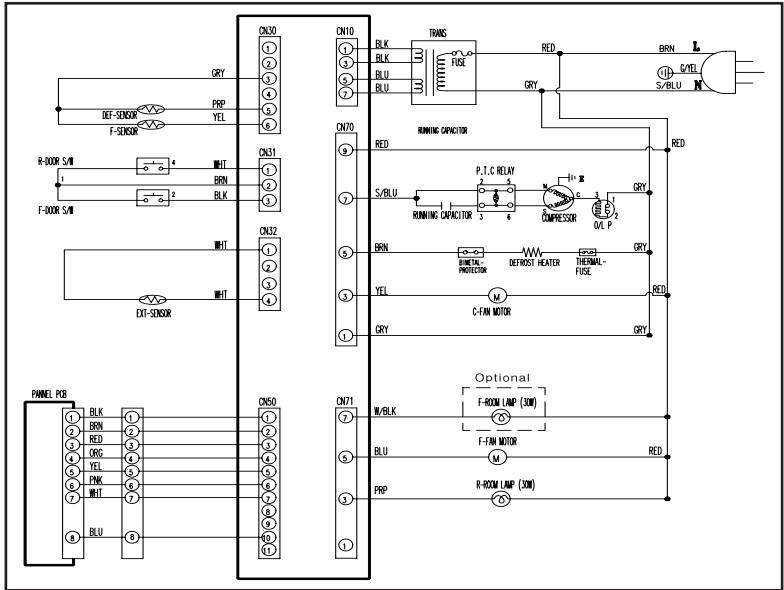

MECHANICAL CONTROL TYPE

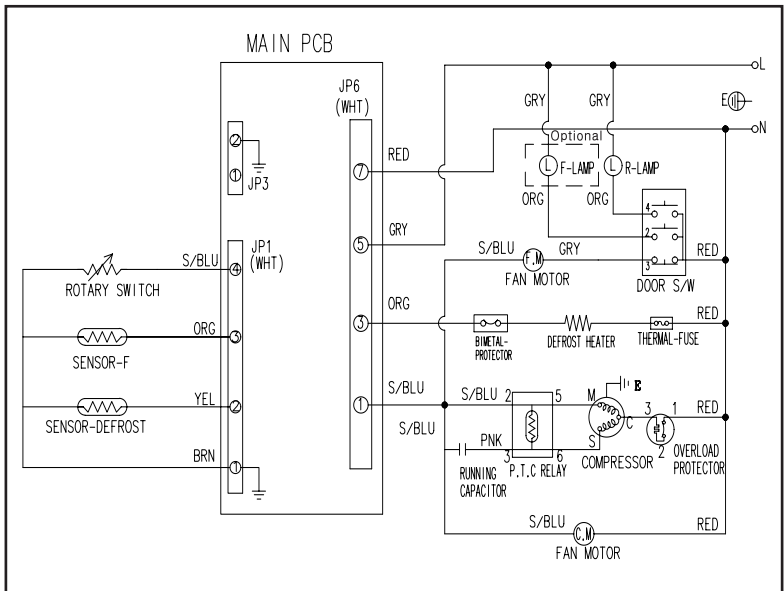

memo

memo

Ambient Room Temperature Limits

This fridge/freezer is designed to operate in ambient temperatures specified by its temperature class marked on the rating plate.

Class	Symbol	Ambient Temperature range(°C)
Extended Temperate	SN	+10 to +32
Temperate	N	+16 to +32
Subtropical	ST	+16 to +38
Tropical	T	+16 to +43

NOTE: Internal temperatures may be affected by such factors as the location of the fridge/freezer, ambient temperature and the frequency with which you open the door. Adjust the temperature as required to compensate for these factors.

English



**Correct Disposal of This Product(Waste Electrical & Electronic Equipment)
(Applicable in the European Union and other European countries with separate collection systems)**

This marking shown on the product or its literature, indicates that it should not be disposed with other household wastes at the end of its working life. To prevent possible harm to the environment or human health from uncontrolled waste disposal, please separate this from other types of wastes and recycle it responsibly to promote the sustainable reuse of material resources.

Household users should contact either the retailer where they purchased this product, or their local government office, for details of where and how they can take this item for environmentally safe recycling.

Business users should contact their supplier and check the terms and conditions of the purchase contract. This product should not be mixed with other commercial wastes for disposal.

Contact SAMSUNG WORLD WIDE

If you have any questions or comments relating to Samsung products, please contact the SAMSUNG customer care center.

COUNTRY	CALL	Web site
AUSTRALIA	1300 362 603	www.samsung.com/au
COLOMBIA	01-8000112112	www.samsung.com.co
EIRE	0818 717 100	www.samsung.com/ie
HONG KONG	3698-4698	www.samsung.com/hk
INDIA	3030 8282, 1800 110011, 1-800-3000-8282	www.samsung.com/in
MALAYSIA	1800-88-9999	www.samsung.com/my
NEW ZEALAND	0800 SAMSUNG (0800 726 786)	www.samsung.com/nz
PANAMA	800-7267	www.samsung.com/latin
PHILIPPINES	1800-10-SAMSUNG(726-7864) 1-800-3-SAMSUNG(726-7864) 02-5805777	www.samsung.com/Ph
SINGAPORE	1800-SAMSUNG(726-7864)	www.samsung.com/sg
SOUTH AFRICA	0860-SAMSUNG(726-7864)	www.samsung.com/za
U.K	0845 SAMSUNG(726-7864)	www.samsung.com/uk
VIETNAM	1 800 588 889	www.samsung.com/vn



In an effort to promote recycling this user manual is printed on recycled paper.



app