



# SIDE BY SIDE REFRIGERATOR USER'S MANUAL AND INSTALLATION INSTRUCTIONS



Model:

- RS20BR\*\*
- RS20CR\*\*
- RS20NR\*\*
- SRS535NW
- SRS536NP
- SRS537NW
- SRS538HW
- SRS538NP
- SRS539HW
- SRS540HP
- SRS541HPT
- SRS541NP
- SRS542HP



Contact SAMSUNG WORLD WIDE  
If you have any questions or comments relating to Samsung products, please contact the SAMSUNG customer care centre.

Country	Customer Care Centre ☎	Web Site
AUSTRALIA	1300 362 603	<a href="http://www.samsung.com/au">www.samsung.com/au</a>
New zealand	0800 SAMSUNG (0800 726 786)	<a href="http://www.samsung.com/nz">www.samsung.com/nz</a>



DA68-01903E(1)

- ◆ Before operating the appliance, please read this manual carefully and keep for further reference in a handy and safe place.
- ◆ Please follow the operation instructions and the related safety precautions in this manual before your proper operation.
- ◆ Our products are improved constantly and it will not be otherwise informed if there is any change.

Free Standing Appliance



# Contents

<i>SAFETY PRECAUTIONS</i> .....	1
<i>OPERATING INSTRUCTIONS</i> .....	3
PREPARING THE APPLIANCE FOR USE .....	3
FEATURES .....	3
CONTROL PANEL .....	4
TEMPERATURE CONTROL .....	5
OVERVIEW OF YOUR REFRIGERATOR .....	6
MAKING ICE .....	7
FOOD STORAGE GUIDE .....	8
REMOVING ACCESSORIES FROM THE FREEZER .....	10
REMOVING ACCESSORIES FROM THE FRIDGE .....	10
CLEANING THE ACCESSORIES .....	11
REPLACING THE LIGHT .....	11
<i>INSTALLATION INSTRUCTIONS</i> .....	12
INSTALLING REFRIGERATOR .....	12
ADJUSTING DOOR CLEARANCE .....	14
TROUBLESHOOTING .....	15

The contents in this manual include eight models:  
RS20BR\*\*/RS20CR\*\*/RS20NR\*\*/SRS535NW/SRS536NP/SRS537NW/  
SRS538NP/SRS538HW/SRS539HW/SRS540HP/SRS541HPT/  
SRS541NP/SRS542HP.  
The construction of these models are similar,  
therefore RS20BR\*\* is the main object described in this manual.

## AMBIENT ROOM TEMPERATURE LIMITS

This appliance is designed to operate at the ambient temperatures specified by its temperature class marked on the rating plate.

Temperature Class	Symbol	Ambient Temperature	
		Maximum	Minimum
Subtemperate	SN	32°C (90°F)	10°C (50°F)
Temperate	N	32°C (90°F)	16°C (61°F)
Subtropical	ST	38°C (100°F)	18°C (64°F)
Tropical	T	43°C (109°F)	18°C (64°F)

NOTES: the internal temperature may be affected by such factors as appliance location, ambient temperature, and the frequency of your opening the doors. Please adjust the temperature as required to compensate for these factors.

## SAFETY PRECAUTIONS



- Before using your refrigerator, please read this manual thoroughly and keep it in a safe place for further reference.
- The features of the refrigerator you purchased may vary little bit from the descriptions in this manual as the below instructions are involved in various models.
- Children or weak person should not use this refrigerator without supervision.
- Take care of children and prevent them from playing this refrigerator.
- R600a or R134a is refrigerant. Check the compressor power and temperature level sign on the back side of the refrigerator to obtain the information of refrigerant used in refrigerator.

### Caution / Warning Sign

	Can cause injury or death
	Can cause person injury or material damage

### Other Signs

	Never Do
	Never Remove
	NO Touch
	Must Follow
	Must pull out power plug from socket
	Must connect the earth to avoid electric shock
	Friendly Reminding



- ⊘ Never plug several electrical appliances into one multifunctional socket
  - Otherwise it can become potential fire hazard.

Avoid keeping the power socket very close to the back side of refrigerator to ensure no crush or damage to power socket.

- The damaged socket may be over hot to cause fire.

No water spills or flows to refrigerator.

- There is a risk of electric shock or fire.

Do not use spray around the refrigerator.

- There is a risk of explosion or fire.

Do not put heavy object on power cord.

- There is a risk of short circuit or fire.

Do not pull out plug with wet hand.

- There is a risk of electric shock

Do not put any container full filled with water on top of the unit.

- If water spills, it can cause fire or electric shock.

Refrigerator must not be installed where it is damp or easily be spilled by water.

- There is a risk of electric shock or fire if electrical parts have insulation failure.

The materials that can be easily volatilized or be flammable shall not be stored in the unit.

- It can cause explosion if benzene, thinner, ethanol, aether, LP gas or the other similar materials are stored.

- ⊘ Do not dismantle or repair the refrigerator by yourself.
  - There is a risk of fire, malfunction and person injury.

- Pull out plug from power socket before replacing the light bulb in the refrigerator.
  - Otherwise, there is a risk of electric shock.

- The door and rubber seal of refrigerator should be dismantled first before disposing and throwing away the unit.

- It can avoid locking children in the unit.

- Refrigerator must be earthed.

- Refrigerator must be earthed to prevent energy consumption or electric shock caused by refrigerator power leakage.

- Gas piped, phone lined or the other potential lightning rodd shall not be used as earth point.

- It can cause electric shock if earth plug is not used properly.



- Keep air vent and channel inside the refrigerator clean to prevent blocking.

- Remove frost according to the recommendations by the manufacturer. No mechanical equipment or the other methods shall be used.

- Refrigerant system and electrical circuit shall not be damaged.

- Do not use the other electronic products inside the refrigerator except those recommended by the manufacturer.

- No tread on leg cover at the bottom.

## SAFETY PRECAUTIONS



### CAUTION



- Do not overfill the refrigerator with food.
- If food falls out when you open the doors, there is a risk of personal injury or material damage.

Do not store bottles or glass containers in the freezer.

- When the contents freeze, the glass may break and cause personal injury.

If power socket is loose, do not insert plug.

- There is a risk of electric shock or fire.

Do not disconnect the power cord by pulling on its head.

- Damage to the cord may cause a short circuit, fire or electric shock.
- If power cord is damaged, it must be replaced by the manufacturer, a certified service agent or qualified service person.

Do not store articles on top of the unit.

- When you open or close the doors, the articles may fall and cause personal injury or material damage.

Do not store medicine, scientific materials and the other temperature-sensitive products in the freezer.

- Check product label to make sure the refrigeration is not prohibited.
- This appliance is not intended for use by young children or infirm persons unless they have been adequately supervised by a responsible person to ensure that they can use the appliance safely.
- Young children should be supervised to ensure that they do not play with the appliance.

- Do not let children hang on the counter and doors.

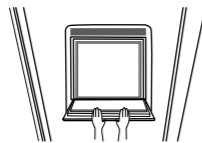

- Do not let children hang on the shelf in the unit.

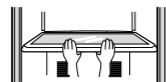

- Do not let children hang on the food guard on the doors.

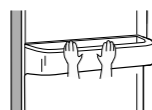

### CAUTION

Refrigerant decides the refrigeration of refrigerator and it is filled into the refrigerator with special process. Ensure the piping behind refrigerator is undamaged.



Small amount of high-temperature, environmental protected Isobutane refrigerant and gas is included in the refrigerator, but they are also very flammable. Handle the refrigerator carefully to ensure the refrigerant system is not damaged during transportation and installation of this unit.

The refrigerant leaked from the piping may be ignited or cause injury to the eyes. If refrigerant leakage is found, fire or potential fire source shall be avoided and ventilate the room where the refrigerator is for several minutes.

- The room size for refrigerator shall be determined according to the quantity of refrigerant in the appliance to avoid that the refrigerant leaked from piping circuit is mixed with the air to generate flammable mixture.

The room size for the appliance shall be calculated according to 8g of refrigerant type R600a per cubic meter. Refer to the instruction in the refrigerator for the details of refrigerant quantity in the unit.

- Do not start up refrigerator if there is any damage in the unit. Please contact dealer or service center for any query.



- If there is abnormal noise, odor or smoke, pull out the plug immediately and contact your nearest Samsung service center.



- Do not put your hand in the area underneath the unit.
- Any sharp edge may cause personal injury.

Do not touch the inside wall of the freezer or products or food stored in the freezer with wet hands.

- It may cause frostbite.

- Do not use a wet or damp cloth to remove any foreign materials from the power plug pins when cleaning the plug.
- There is a risk of burning and fire.

If you wish to move the refrigerator, hold it by handle on its back and bottom sides.

- If the appliance power is disconnected, you have to wait for at least five minutes before plugging it back.



- If you will not use the refrigerator for a long period of time, please pull out of power plug.

- Any deterioration in the insulation may cause fire.

## TROUBLESHOOTING

### The refrigerator does not work at all or can not chill sufficiently

- Check that the power plug is properly connected.
- Check that the power plug fuse has not blown.
- Is the temperature control set to the proper temperature?
- Is the refrigerator in direct sunlight or located near a heat source?
- Is the back of the refrigerator too close to the wall?

### The food in fridge is frozen

- Is the temperature control set to the proper temperature?
- Is the temperature in the room too low?
- Did you put food with a high water content near the coldest part of the fridge.

### You can hear abnormal noise or sound

- Check that the floor is level and stable.
- Is the back of the appliance too near to the wall?
- Has anything dropped behind or under the appliance?
- Is the noise from the compressor in the appliance?
- A "ticking" sound may be heard from inside the appliance, but this is normal. It is caused when the various accessories contract or expand.

### The front corners and sides are equipped with heat radiator. It is normal to be hot.

- The front corner of refrigerator is equipped with frost device to prevent condensation.
- Both sides of the refrigerator are equipped heat pipes and it is normal to be hot.

### There is some condensate water inside the refrigerator, which is normal.

- Condensation can result of leaving the door open too long or storing unwrapped food with a high water content when outside temperature and humidity are high.

### There is odor inside the refrigerator

- You did not wrap food with a strong smell properly or you have left something in the refrigerator too long.
- Always wrap food with a strong smell so that it is airtight.
- Always throw away the food that has gone off.

### Frost forms on the wall of the freezer

- Is air inlet/outlet blocked?
- Always allow sufficient space between the food items for efficient air circulation.
- Is the door closed properly?

## GENERAL KNOWLEDGE OF REFRIGERATOR SILENCE

The refrigerator runs through compressor and lowers the temperature inside by the procedures such as refrigerant circulation to ensure the freshness and nutrition of the food inside the refrigerator. When the refrigerator is running, you may hear some slight sounds. Please take it easy because it is normal and will not have any influence on the refrigerator application.

### 1 Slight "humming" sound

When the compressor is running, the startup sound is slight high. High-efficient refrigerator has higher sound due the strong working capacity of the compressor.

### 2 Air or Water flow Sound

The temperature inside the refrigerator can be lowered quickly when refrigerant is flowing in the pipes. There are two kinds of refrigerants, gas and liquid. Slight sound may be heard during its flowing.

### 3 "Clattering" Sound

When starting and stopping the refrigerator, the electrical components such as main control panel, startup breaker and heat protector give off "Clattering" sounds because of being constantly on or off.

### 4 Slight "Whishing" Sound

A fan is installed inside the refrigerator to improve air circulation. When the fan is running, it will give off the sounds of air flow and motor running. In the other hand, the fan running can ensure that the temperature inside can be decreased rapidly and evenly, which have great impact on keeping food fresh and nutritional; on the other hand, the fan running can increase the cooling effects of the refrigerator.

### 5 Frost Crack Sound and "Pooping" Sound

When the refrigerator is running, due to the variation of temperature differences, the food is frost cracked or evaporator and pipe line gives off "pooping" sound due to hot expansion and cold contraction.

# ADJUSTING DOOR CLEARANCE



## Adjusting the slight differences between the doors.

If the door of freezer is lower than that of fridge.



If the door of freezer is higher than that of fridge.



Please open the doors and adjust the doors as follows:

- 1) Release the nut ( ) on the lower hinge until the upper end of the bolt ( ).



NOTE When you release the nut ( ), use hexagonal wrench ( ) to turn the bolt ( ) a little counterclockwise to make the nut ( ) loose with your fingers.

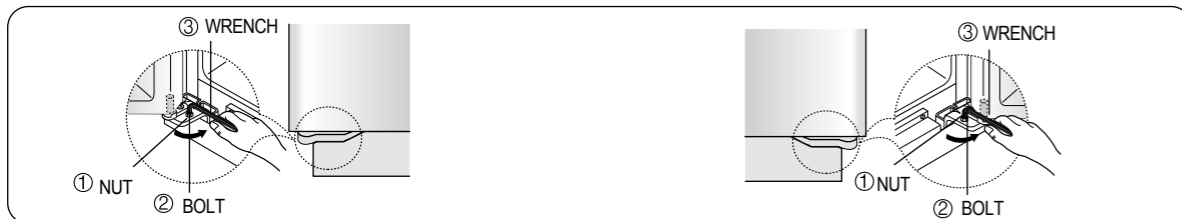

- 2) Please adjust height difference between the doors by turning the bolt ( ) clockwise ( ) or counterclockwise ( ).



NOTE When you turn clockwise ( ), the door goes up.

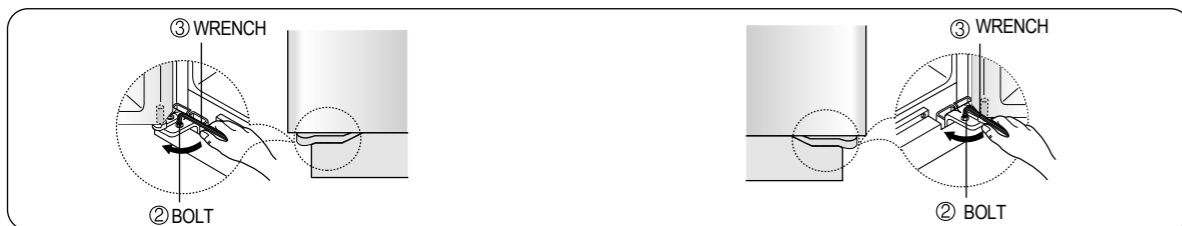

- 3) After adjusting the doors, turn the nut ( ) clockwise ( ) until the lower end of the bolt, and then tighten the bolt again with the wrench ( ) to fix the nut ( ).



- NOTE
- If you do not fix the nut ( ) firmly, the bolt ( ) may be released.
  - Do not press power cord.
  - If throwing away the refrigerator, please remove the rubber door seal first.

# PREPARING THE APPLIANCE FOR USE

Once you have performed the following steps, your refrigerator should be fully operational. If not, please check the power supply and electricity source.

If you have any doubts or problems, please contract your nearest SAMSUNG service center.



1 Place the shelves and containers which were removed for transportation in their appropriate positions (refer to pages 8 to 9).



4 Set the temperature control to the lowest temperature and wait for one hour. The refrigerator should not be slightly cooled and the compressor should run smoothly producing soft humming noises.



2 Clean the freezer/refrigerator and accessories to remove any dust accumulated during packaging and shipping (refer to page 9).



5 Once the refrigerator temperature is sufficiently low, you can begin storing food inside. Please be advised that it takes a few hours to reach the appropriate temperature after the refrigerator is running.



3 When the refrigerator is plugged in, the interior bulb should light every time the refrigerator interior door is opened.



NOTE verify voltage range, electrical wire and socket can stand the electrical circuit above 10A before power is connected.

# FEATURES

## Multi-flow System

- Cooling air circulates through each vent. This provides even distribution of cooling strength inside the refrigerator and keeps food fresh for a long period of time.

## High Humidity for Fresher Food

- You can keep food, fruits and vegetables fresh for a long period of time because your refrigerator supplies very humid cooling air.

## Door Alarm

- If the refrigerator door is kept open for more than two minutes, the musical alarm is automatically triggered. This feature helps you save energy and preserve stored food.

## Bar Counter Feature

- It is convenient to store frequent-used drinks and food and reduce the cold air loss in the unit.

**CONTROL PANEL**  
(RS20BR\*\*/RS20CR\*\*/SRS538HW/SRS539HW/SRS540HP/SRS541HPT/SRS542HP)

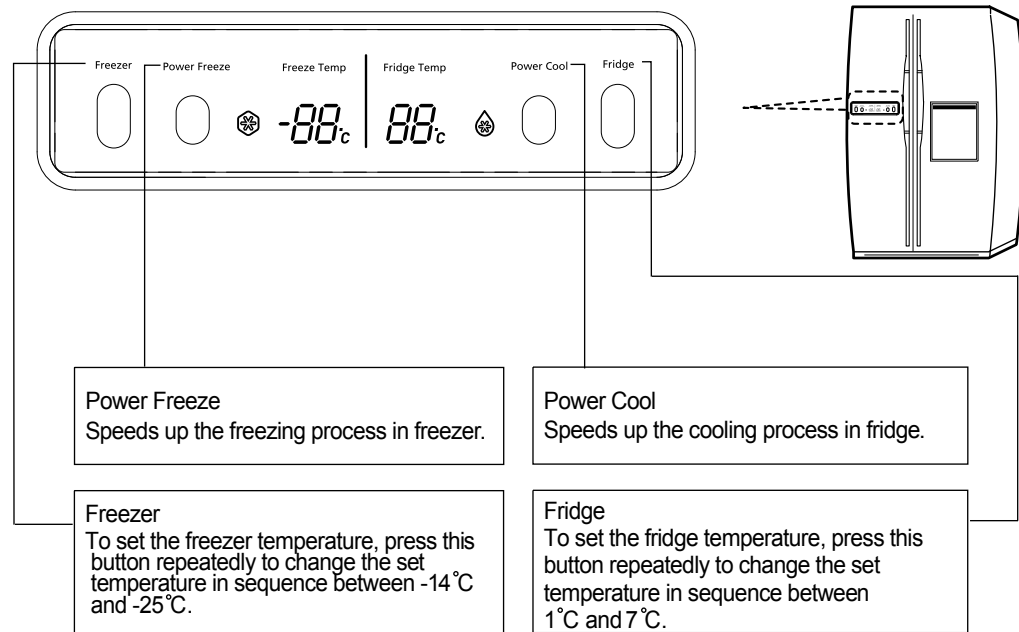

**DIGITAL PANEL**

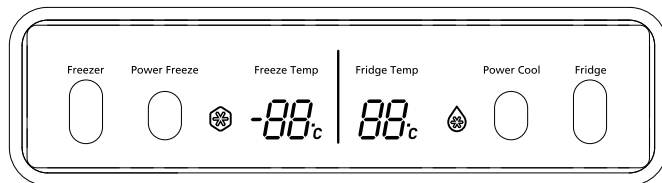

Freeze Temp: indicate the current freeze temperature. Fridge Temp: indicates the current fridge temperature.

**Power Freeze**



- This light is on when you pressure the Power Freeze button. Press this button to make the freezer reach the set temperature quickly.
- Press this button again to cancel the Power Freeze mode.

**Power Cool**



- This light is on when you press the Power Cool button. Pressure this button to make the fridge reach the set temperature quickly.
- Pressure this button again to cancel the Power Cool Mode.

**Note** The inside temperature of the appliance will increase if a large amount of hot articles are stored at the same time, or the doors are opened frequently or for a long time.  
If you need to freeze large amount of food stuff, set the temperature of freezer compartment as the coldest temperature before you turn on the Power Freeze Button.

**INSTALLING REFRIGERATOR**



**LEVELLING**

When you adjust the refrigerator level, set the front legs slightly higher than the rear legs so that you can open and close the doors more easily.  
First disassemble the leg cover and then adjust the refrigerator level.

**1**

If your refrigerator tilts towards the left, turn the left adjusting leg.

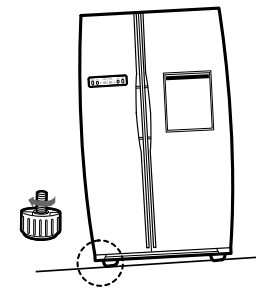

**2**

If your refrigerator tilts towards the right, turn the right adjusting leg.

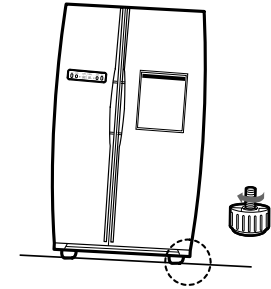

**EARTHING THE APPLIANCE**



**WARNING**

- The appliance must be earthed before use.
- You must earth the refrigerator to prevent any power leakage or electric shock caused by current leakage from the appliance.
- Never use gas pipes, phone lines or other potential lightning rods as earthing.

Never use unearthed power plug.

- Connect the earthing wire (yellow/green or green).

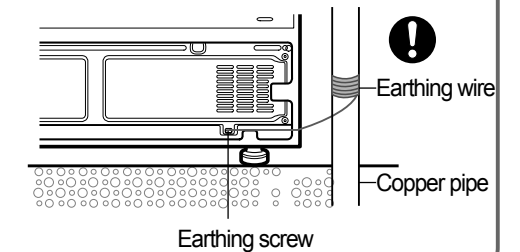

# INSTALLING REFRIGERATOR

## ENVIRONMENT

Please dispose of the packaging materials for this product in an "environmentally friendly" manner. For further detail, please contact your local area authority.

### Check the dimensions of your entrance door.

Check the dimensions of your entrance door to determine whether the refrigerator can pass through it.

\* Dimension of the Appliance

	Dimension (mm)	Remarks
Width	855	
Depth	756	With door
Height	1728	With hinge

Remove all packing materials:

Remove the foam pad for the appliance before using it.

Allow a clearance of 10cm to the right, left and rear side when installing the appliance; as this will help to reduce power consumption.

**1** Allow sufficient space to install the appliance on a flat surface.

- If your appliance is not level, the internal cooling system may not work properly.

Over 10cm

**2** Clean your refrigerator.

- Wipe the inside and outside of your refrigerator with a dry cloth.

**3** Store food in the refrigerator.

- Wait for at least two or three hours after plugging your appliance in and before storing food and other articles inside.

## TEMPERATURE CONTROL (RS20NR\*\*/SRS535NW/SRS536NP/SRS537NW/SRS538NP/SRS541NP)

FRE. TEMP    REF. TEMP

colder

cold

LED No. ⑤

LED No. ④

LED No. ③

LED No. ②

LED No. ①

**FRE. TEMP BUTTON**  
To set the freeze temperature, push the button repeatedly to select from level 1 (cold) to level 9 (colder).

**REF. TEMP BUTTON**  
To set the refrigerator temperature, push the button repeatedly to select from level 1 (cold) to level 9 (colder).

**NOTE**

- The higher level you set, the lower temperature inside the unit.

## TEMPERATURE CONTROL

### FREEZE

- The freeze temperature can be set to any level from level 1 (cold) to level 9 (colder).
- Press FRE. TEMP button repeatedly until the desired level is reached.
  - At each level, the LED indicators turn on or off as shown on the table.

### Refrigerator

- The refrigerator temperature can be set to any level from level 1 (cold) to level 9 (colder).
- Press REF. TEMP button repeatedly until the desired level is reached.
  - At each level, the LED indicators turn on or off as shown on the table.

### Control Level Table

Reference	Cold → Normal → Colder								
	1	2	3	4	5	6	7	8	9
LED CONDITION	⑤	⑤	⑤	⑤	⑤	⑤	⑤	⑤	●
● (On)	④	④	④	④	④	●	●	●	●
○ (Off)	③	③	③	③	●	●	●	●	●
◐ (Blink)	②	②	●	●	●	●	●	●	●
Level	1	2	3	4	5	6	7	8	9

※ At level 2, 4, 6 and 8, LED marked with (◐) will fully light up after blinking for 5 seconds (●).

- NOTE**
- For your convenience, your refrigerator temperature control has been preset in the factory.
  - Refrigerator temperature controller shall be set as "NORMAL" (level 5: -20 for Freeze and 3 for Fridge if your refrigerator is installed first time or has been switched off for a long time.
  - When accidental power off happens and the power is reconnected, please check the status of temperature controller. User is suggested to set according to your actual application conditions and normal recommended setting is NORMAL.
  - If you need to freeze large amount of food stuff, set the temperature of freezer compartment as the coldest temperature at least 24 hours before.

# OVERVIEW OF YOUR REFRIGERATOR

## FREEZER / REFRIGERATOR (RS20BR\*\*/SRS538HW/SRS539HW/SRS540HP/SRS541HPT/SRS542HP)

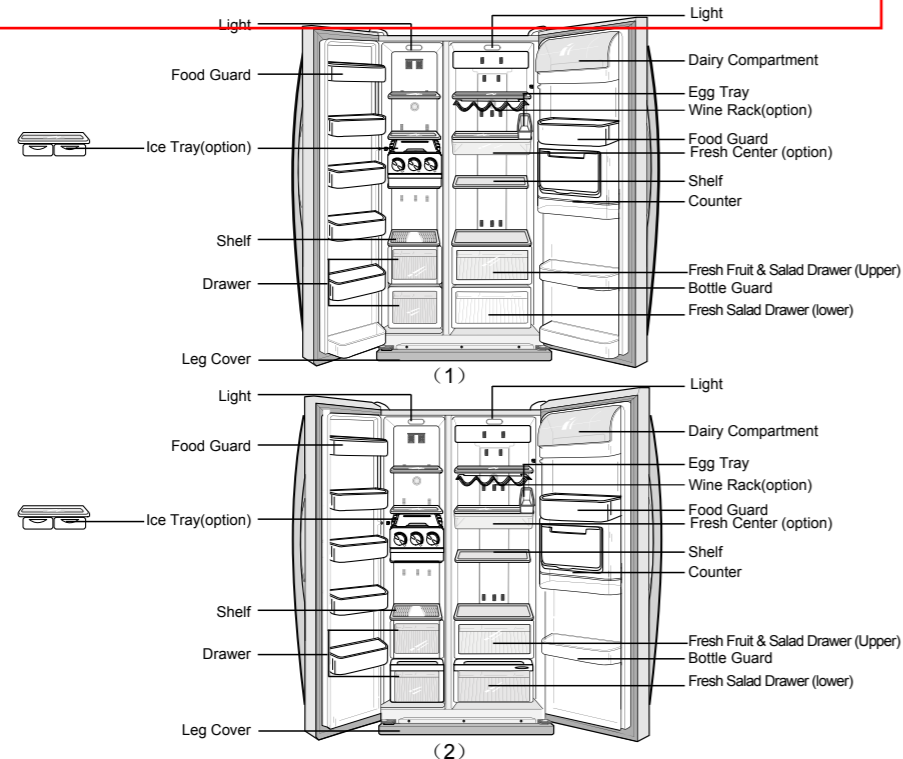

## FREEZER / REFRIGERATOR (RS20CR\*\*)

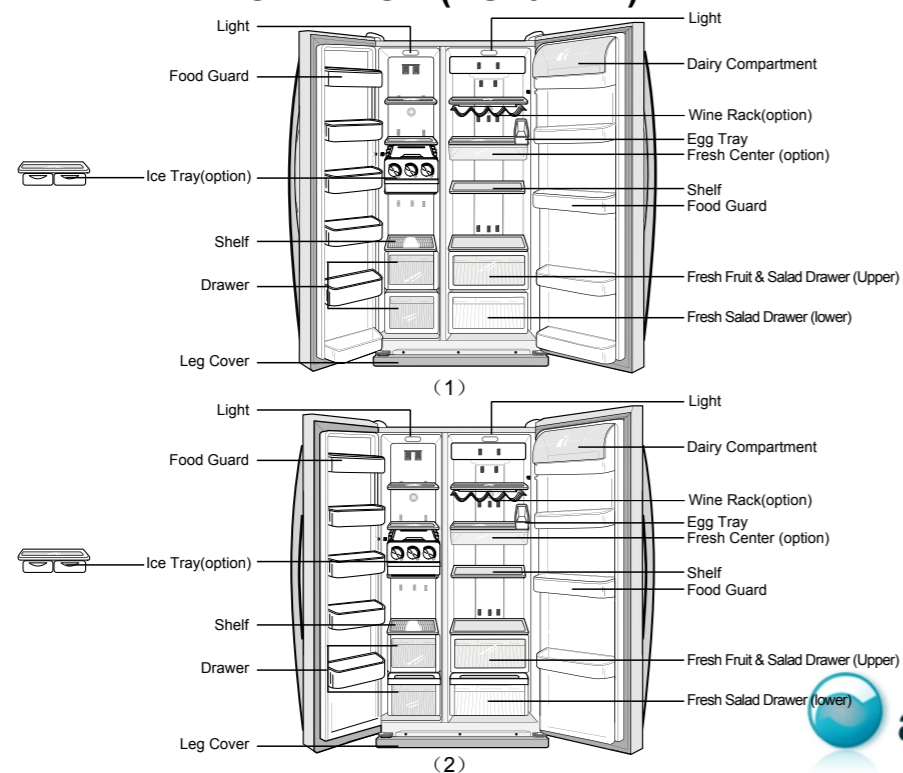

# CLEANING THE ACCESSORIES

### Inside

- Clean the accessories with a mild detergent. Then wipe with a dry cloth.
- After washing the accessories, make sure that they are dry before using them again.

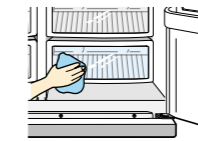

### Rear

- Use a vacuum cleaner to remove dust once or twice a year.

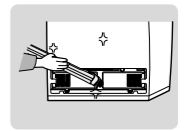

### Rubber Door Seals

- If the rubber door seals are dirty, the door will not be closed properly and the refrigerator will be unable to run efficiently. Clean them with a mild detergent and damp cloth. Then wipe them with a dry cloth.



### Exterior

- The doors and door handles should be cleaned with a mild detergent and cloth. Dry them with a clean cloth.
- The exterior should be cleaned once or twice a year.



**WARNING**

- When cleaning the appliance or if the appliance will not be used for a long time, always turn the power off, leave the doors open and keep the appliance dry.
- Do not clean it by spraying it directly with water.
- Do not clean it with benzene, thinner or car detergent.

# REPLACING THE LIGHT

## LIGHTBULBS



**WARNING**

Before replacing the light bulbs, unplug the appliance from the power supply. If you meet difficulties when you attempt to replace the light bulbs, please contact your nearest SAMSUNG service center.

**1**

- Remove the lamp cover. Use the screw driver to remove the screws securing the lamp cover.

**2**

- After replacing the bulb, reassemble the cover with the screw.

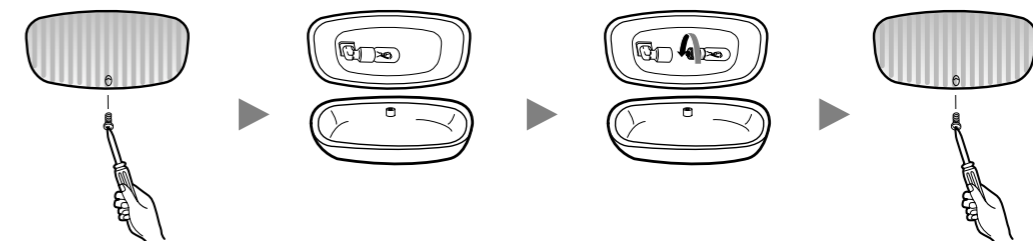

**NOTE**

The rated voltage of lightbulbs are indicated around the lamp holder or on lightbulbs.

## LED LIGHT



**CAUTION**

Do not replace LED lamp privately and please contact the specialized repair staff if necessary. And make it sure that the new LED lamp is the same as the old one. Do not break the lamp cover.



## REMOVING ACCESSORIES FROM THE FREEZER

### 1 Tempered Glass Shelf

- Pull the shelf out as far as it goes. Then lift it up and remove it.

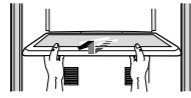

### 4 Ice Tray and Cube

- Remove the ice tray by pulling it outwards.

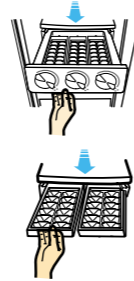

### 2 Food Guard

- Hold the guard with both hands and then lift it up.

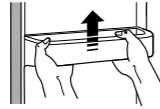

### 5 Leg Cover

- Only remove the leg cover when absolutely necessary.
- Open the freezer and refrigerator doors, remove the three screws and detach the leg cover.
- To reassemble the leg cover, replace it in this original position and tighten the three screws.

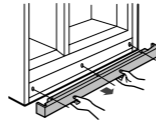

### 3 Drawers

- Remove the drawings by pulling it out and lifting it up slightly.

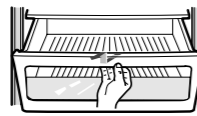

**WARNING**

- Do not use excessive force when removing the accessories, otherwise, it may cause personal injury.
- Do not place top side shelf of freezer in any other location. It may get dropping, damaged and cause personal injury.
- Before removing accessories from the freezer and refrigerator, always remove stored food to the other space first.
- Do not put food on ice tray and take out it separately when not in use.

## REMOVING ACCESSORIES FROM THE FRIDGE

### 1 Tempered Glass Shelf

- Pull the shelf out as far as it goes. Then lift it up and remove it.

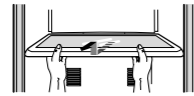

### 3 Fresh Fruit & Salad Drawer and Lower Shelf

- Remove the drawer by holding the handle, pulling the drawer outwards and lifting it up slightly.
- Remove the lower shelf by pulling it outwards.
- Follow the sequences (first, remove fresh fruit & salad drawer before removing the lower shelf).
- Lower shelf can be damaged if you do not follow the sequences.

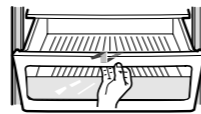

### 2 Bottle Guard and Food Guard

- Hold the guards with both hands and then remove it by, lifting it up.

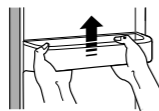

### 4 Counter

- Hold the food guard with both hands and remove it by lifting it up.
- Hold the counter compartment with both hands and remove it by lifting it up.
- Follow the sequences (first, remove food guard, and then remove counter compartment).

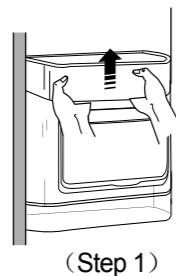

(Step 1)

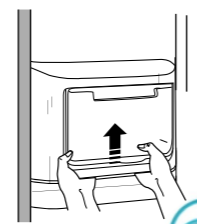

(Step 2)

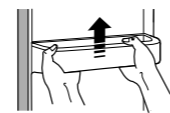

(Step 3)

**appliancesonline**  
.com.au

Australia's largest online appliance retailer

## FREEZER / REFRIGERATOR (RS20NR\*\*/SRS535NW/SRS537NW/SRS538NP/SRS541NP)

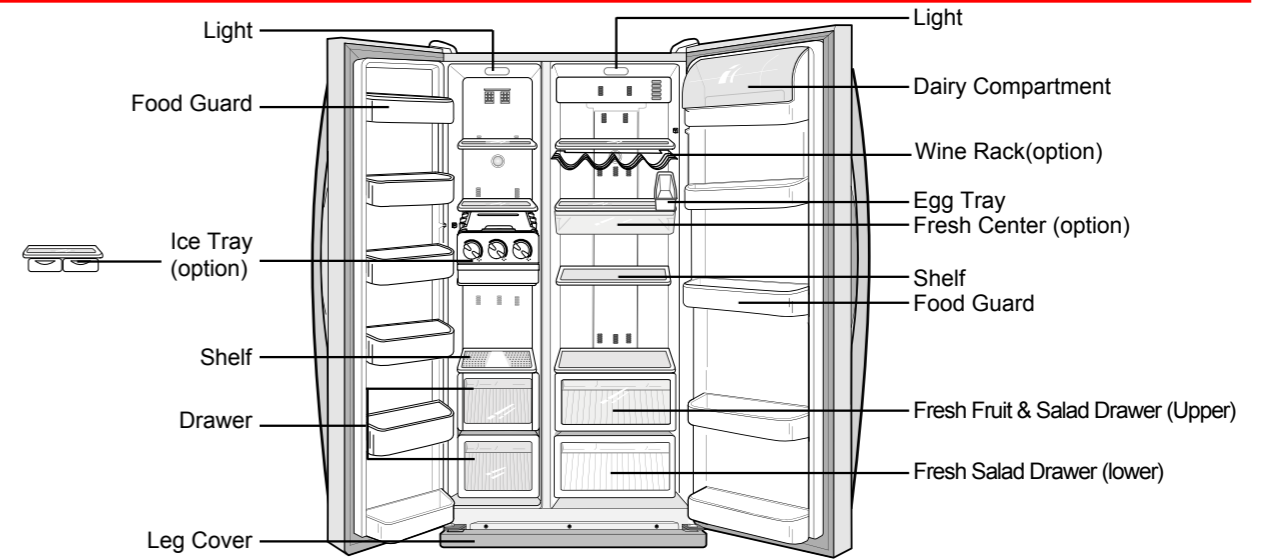

## MAKING ICE

### 1 Pull out the ice tray.

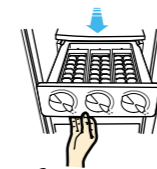

### 3 Place it inside ice tray.

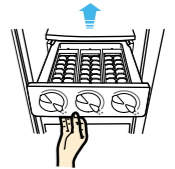

### 2 Pour cool water into the tray until it reaches the water level indicator on the tray.



### 4 Turn ice tray button and the ice automatically full into the below ice compartment after release. Pull out ice storage compartment for ice.

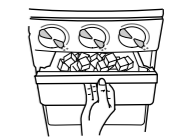

### 1 Pull out the ice tray.

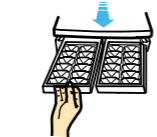

### 3 Place it under the freezer shelf or on the freezer shelf.

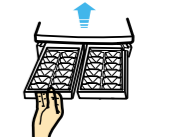

### 2 Pour water into the tray until it reaches the water level indicator on the tray.



### 4 To separate individual ice cubes, pull out the ice tray and hold the ice tray by its ends, then twist it gently.



## COUNTER USAGE

### 1 Open counter door.

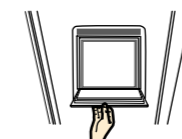

### 3 Take away the food or drink after use.



### 2 Put food or drink on the counter.



### 4 Close counter door.



# FOOD STORAGE GUIDE

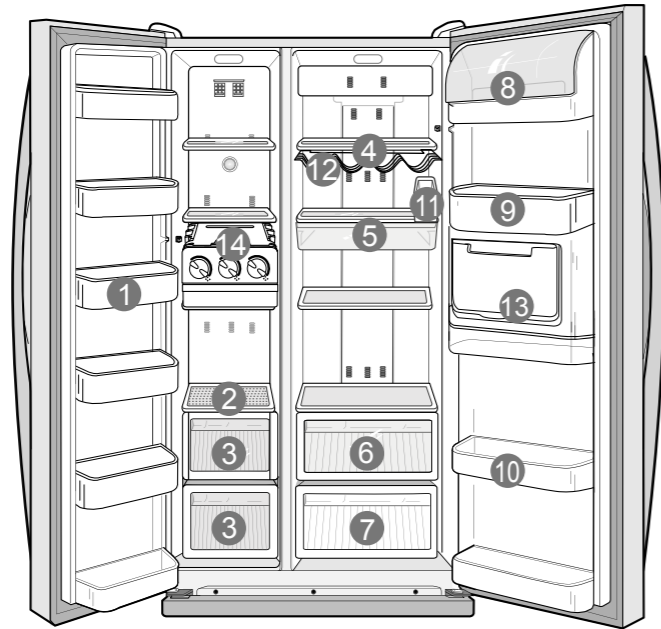

## FOOD STORAGE GUIDE

- 1 Food Guard**
  - For storing small packages of frozen food.
- 2 Tempered Glass Shelf**
  - For storing all types of frozen food.
- 3 Meat and Dry Goods Storage Compartment**
  - For storing meat and dry goods. Stored food should be wrapped securely using foil or other suitable wrapping materials.
- 4 Tempered Glass Shelf**
  - Can be used safely.
- 5 Fresh Center (option)**
  - Preserve the taste of food and prolongs its freshness. Use the fresh center to store cheese, meat, snacks, fish or any food to be used quickly.

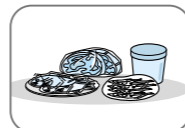
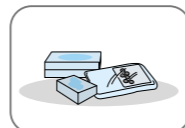
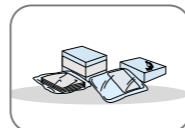

# FOOD STORAGE GUIDE

- 6 Fresh Fruit & Salad Drawer(upper)**
  - Store vegetables and fruits.
- 7 Fresh Fruit & Salad Drawer (lower)**
  - Store vegetables and fruits.
  - This drawer is comparatively air tight and the food installed in this drawer and other food in the freezer will not affect with each other, therefore it can receives its taste inside freezer.
- 8 Dairy Compartment**
  - Stores fatty food, like butter and cheese
- 9 Food Guard**
  - Stores small packages of milk and yoghurt etc.

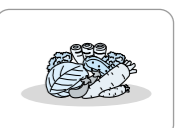
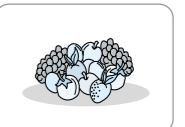

- 10 Bottle Guard**
  - Stores various types of bottles and cans.
- 11 Egg Tray**
  - Stores eggs in egg tray and then place the tray on the tempered glass shelf.
- 12 Wine Shelf**
  - Stores wine for a short time.
- 13 Counter**
  - Can take drink and food conveniently.
- 14 Ice Tray**
  - For ice making. It can be put outside when not making ice.

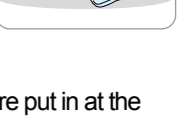
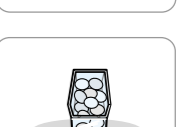

- NOTE**
- Food stored under ambient temperature of 5°C or lower can be frozen.
  - The temperature inside the refrigerator can be increased if a large amount of hot articles are put in at the same time. The temperature returns to normal usually after twenty-four hours.
  - There should be several others when the refrigerator reaches the proper temperature after it starts up. Please put in food after the temperature is sufficiently low.
  - For liquid or very humid food (such as fruits and vegetables), they should be stored in sealed condition or after they are cleaned dry.
  - Do not open the doors frequently or keep it open for a long period time so that the refrigerator efficiency will not be affected and running loads will not be increased.
  - There may be fog on the surfaces of inside accessories when freezer door is opened, which is normal.
  - There is small amount of condensate water partially in the refrigerator when the surrounding temperature is very high, which is normal.
  - During making ice, do not use hot water and it is recommended not to change the location of ice tray set in the factory.