

WA5471AB*



Washing Machine user manual

Planet
First

100%
Recycled Paper

This manual is made with 100% recycled paper.

imagine the possibilities

Thank you for purchasing a Samsung product.
To receive a more complete service, please
register your product at

www.samsung.com/register

SAMSUNG

key features of your new washer

1. VRT® (Vibration Reduction Technology)

The Samsung washer performs smoothly at top spin speeds helping to minimize noise and vibration.

2. The large Capacity

Even bulky garments and blankets get super clean. The large capacity leaves enough room for a thorough, clean wash.

3. Eco Tub Clean

Clean your drum with one button! Eco Tub Clean is specially designed to remove detergent residue and dirt buildup in the tub, without the need for special chemical detergents.

4. Stylish design

The stylish design of this washer blends well with your decoration.

5. Center jog dial

The Jog dial enables you to select cycles in both directions with ease.

6. DD Motor

The power to handle just about anything! Our direct-drive inverter motor delivers power right to the washer tub from a variable speed, reversible motor. A beltless direct-drive motor generates a high spin speed of 1,100rpm for effective, quiet operation. The washer also has fewer moving parts than other Samsung washers fewer repairs.

7. Tempered Glass Lid

The tempered glass lid is durable and makes it easy to see the inside of the washer.

8. Lid Lock Switch

The washer lid is locked during operation. The lid can be unlocked by pressing the Start/Pause button to stop the washer.

safety information













Congratulations on your new Samsung Washer. This manual contains important information on the installation, use, and care of your appliance. Please take time to read this manual to take full advantage of your washer's many benefits and features.

WHAT YOU NEED TO KNOW ABOUT SAFETY INSTRUCTIONS

Warnings and Important Safety Instructions in this manual do not cover all possible conditions and situations that may occur. It is your responsibility to use common sense, caution, and care when installing, maintaining, and operating your washer.

IMPORTANT SAFETY SYMBOLS AND PRECAUTIONS

What the icons and signs in this user manual mean:

 WARNING	Hazards or unsafe practices that may result in severe personal injury or death .
 CAUTION	Hazards or unsafe practices that may result in minor personal injury or property damage .
 CAUTION	To reduce the risk of fire, explosion, electric shock, or personal injury when using your washer, follow these basic safety precautions:
 CAUTION	To reduce the risk of fire or explosion, follow these basic precautions.
	Do NOT attempt.
	Do NOT disassemble.
	Do NOT touch.
	Follow directions explicitly.
	Unplug the power plug from the wall socket.
	Make sure the machine is grounded to prevent electric shock.
	Call the service center for help.
	Note

These warning signs are here to prevent injury to you and others.

Please follow them explicitly.

After reading this section, keep it in a safe place for future reference.

 Read all instructions before using the appliance.

As with any equipment using electricity and moving parts, potential hazards exist. To safely operate this appliance, become familiar with its operation and exercise care when using it.

safety information

Do not let children (or pets) play on or in your washing machine. The washing machine door does not open easily from the inside, and children may be seriously injured if trapped inside.



This appliance is not intended for use by persons (including children) with reduced physical, sensory or mental capabilities, or lack of experience and knowledge, unless they have been given supervision or instruction concerning use of the appliance by a person responsible for their safety.

Children should be supervised to ensure that they do not play with the appliance.

If the plug (power supply cord) is damaged, it must be replaced by the manufacturer or its service agent or a similarly qualified person in order to avoid a hazard.

This appliance should be positioned to be accessible to the power plug, the water supply tabs and the drain pipes.

For washing machines with ventilation openings in the base, ensure that the opening is not obstructed by carpet or any other obstacles.

Use the new hose-sets and old hose-sets should not be reused.



CRITICAL INSTALLATION WARNINGS



Plug the power cord into an AC 220~240V/50Hz wall socket rated at 15 amps or higher. Use the socket for this appliance only. In addition, do not use an extension cord.

- Sharing a wall socket with other appliances, using a power strip, or extending the power cord may result in electric shock or fire.
- Do not use an electric transformer. It may result in electric shock or fire.
- Ensure that the power voltage, frequency, and current match the product's specifications. Failing to do so may result in electric shock or fire.

Have this appliance installed by a qualified technician or service company.

- Failing to do so may result in electric shock, fire, an explosion, problems with the product, or injury.

Remove all foreign substances such as dust or water from the power plug terminals and contact points using a dry cloth on a regular basis.

- Unplug the power plug and clean it with a dry cloth.
- Failing to do so may result in electric shock or fire.

Plug the power plug into the wall socket in the right direction so that the cord runs towards the floor.

- If you plug the power plug into the socket in the opposite direction, the electric wires within the cable may be damaged and this may result in electric shock or fire.
-



This appliance must be properly grounded.

Do not ground the appliance to a gas pipe, plastic water pipe, or telephone line.

- Improper grounding may result in electric shock, fire, an explosion, or problems with the product
 - Never plug the power cord into a socket that is not grounded correctly. Make sure the socket you use is grounded in accordance with local and national codes.
-



Do not install this appliance near a heater or inflammable material.

Do not install this appliance in a humid, oily, or dusty location, or in a location exposed to direct sunlight or water (including rain drops).

Do not install this appliance in a location where gas may leak.

- This may result in electric shock or fire.

Plug the power plug into the wall socket firmly. Do not use a damaged power plug, damaged power cord, or loose wall socket.

- This may result in electric shock or fire.

Do not pull or excessively bend the power cord.

Do not twist or tie the power cord.

Do not hook the power cord over a metal object, place a heavy object on the power cord, insert the power cord between objects, or push the power cord into the space behind the appliance.

- This may result in electric shock or fire.

Do not pull the power cord when unplugging the power plug.

- Unplug the power plug by holding the plug.
 - Failing to do so may result in electric shock or fire.
-



If the power plug or power cord are damaged, contact your nearest service center.

safety information



INSTALLATION CAUTIONS



- Position the appliance so that the power plug is easily accessible.
- Failing to do so may result in electric shock or fire due to electric leakage.

Install your appliance on a level and hard floor that can support its weight.

- Failing to do so may result in abnormal vibrations, noise, or problems with the product.
-



- Unplug the power plug when the appliance is not being used for long periods of time or during a thunder/lightning storm.

- Failing to do so may result in electric shock or fire.
-



CRITICAL USAGE WARNINGS



- If the appliance is flooded, cut the power immediately and contact your nearest service center.

If the appliance generates a strange noise, a burning smell, or smoke, unplug the power plug immediately and contact your nearest service center.

- Failing to do so may result in electric shock or fire.

In the event of a gas leak (such as propane gas, LP gas, etc.), ventilate the area immediately. Do not turn any appliance or light on or off.

- Do not use a ventilating fan.
- A spark may result in an explosion or fire.

Do not wash items contaminated with gasoline, kerosene, benzene, paint thinner, alcohol or other flammable or explosive substances.

- This may result in electric shock, fire, or an explosion.

Do not open the washer door by force while it is operating (high-temperature washing/drying/spinning).

- Water flowing out of the washer may cause burns or cause the floor to be slippery. This may result in injury.
- Opening the door by force may cause damage to the product or injury.

Make sure to remove the packaging (sponge, styrofoam) attached to the bottom of the washer before using it.

Do not insert your hand under the washer.

- This may result in injury.
-



- Do not touch the power plug with wet hands.

- This may result in electric shock.

Do not turn the appliance off by unplugging the power plug while the washer is in operation.

- Plugging the power plug into the wall socket again may cause a spark and result in electric shock or fire.

Keep all packaging materials well out of the reach of children, as packaging materials can be dangerous to children.

- If a child places a bag over its head, it may suffocate.

Do not let children or infirm persons use this washer unsupervised.

- Failing to do so may result in electric shock, burns or injury.

Do not insert your hand or a metal object under the washer while it is operating.

- This may result in injury.
-



Do not attempt to repair, disassemble, or modify the appliance yourself.

- Do not use any fuse (such as cooper, steel wire, etc.) other than the standard fuse.
- If you need to repair or reinstall the appliance, contact your nearest service center.
- Failing to do so may result in electric shock, fire, problems with the product, or injury.



If any foreign substance such as water enters the appliance in any area other than the tub, unplug the power plug and contact your nearest service center.

- Failing to do so may result in electric shock or fire.

If the water supply hose comes loose from the faucet and floods the appliance, unplug the power plug.

- Failing to do so may result in electric shock or fire.



USAGE CAUTIONS



If the washer is contaminated by a foreign substance such as detergent, dirt, food waste, etc., unplug the power plug and clean the washer using a damp and soft cloth.

- Failing to do so may result in discoloration, deformation, damage or rust.

The front glass may be broken by a strong impact. Take care when using the washer.

- If the glass is broken, it may result in injury.

After a water supply failure or when reconnecting the water supply hose, open the faucet slowly.

Open the faucet slowly after a long period of non-use.

- The air pressure in the water supply hose or the water pipe may result in damage to a part or in water leakage.

If a drain error occurs during an operation, check if there is a draining problem.

- If the washer is used when it is flooded because of a draining problem, it may result in electric shock or fire due to electric leakage.

Insert the laundry into the washer completely so that laundry does not get caught in the door.

- If laundry gets caught in the door, it may result in damage to the laundry or the washer, or result in water leakage.

Ensure that the faucet is turned off when the washer is not being used.

- Ensure that the water supply hose connectors are properly tightened.
- Failing to do so may result in property damage or injury.

Open the faucet and check if the water supply hose connector is firmly tightened and that there is no water leaking before using the product.

- If the water supply hose connectors are loose, it may result in water leakage.

The product you have purchased is designed for domestic use only.

The use for business purposes qualifies as product misuse. In this case, the product will not be covered by the standard warranty provided by Samsung and no responsibility can be attributed to Samsung for malfunctions or damages resulting from such misuse.

safety information

- ☐ Do not stand on top of the appliance or place objects (such as laundry, lighted candles, lighted cigarettes, dishes, chemicals, metal objects, etc.) on the appliance.
 - This may result in electric shock, fire, problems with the product, or injury.
- Do not operate the appliance with wet hands.
 - This may result in electric shock.
- Do not spray volatile material such as insecticide onto the surface of the appliance.
 - As well as being harmful to humans, it may also result in electric shock, fire, or problems with the product.
- Do not place an object that generates an electromagnetic field near the washer.
 - This may result in injury due to a malfunction.
- Since the water drained during a high-temperature wash or drying cycle is hot, do not touch the water.
 - This may result in burns or injury.
- Do not wash, spin, or dry water-proof seats, mats or, clothing*.
 - Do not wash thick, hard mats even if the washer mark is on the care label. This may result in injury or damage to the washer, walls, floor, or clothing due to abnormal vibrations.
 - * Items not to wash: Woolen bedding, rain covers, fishing vests, ski pants, sleeping bags, diaper covers, sweat suits, and bicycle, motor cycle, car covers, etc.
- Do not operate the washer when the detergent box is removed.
 - This may result in electric shock or injury due to water leakage.
- Do not insert your hand into the detergent dispenser after opening it.
 - This may result in injury as your hand may be caught.
- Do not place any non-laundry objects, such as shoes, food waste, or animals into the washer.
 - This can cause abnormal vibrations that can damage the washer, and, in the case of pets, cause severe injury or death.
- Do not press the buttons using sharp objects such as pins, knives, fingernails, etc.
 - This may result in electric shock or injury.
- Do not wash laundry contaminated by oils, creams, or lotions usually found in skincare shops or massage clinics.
 - This may result in the rubber seal becoming deformed and water leakage.
- Do not leave metal objects (safety pins, hair pins, etc.) or bleach in the tub for long periods of time.
 - This may cause the tub to rust.
 - If rust appears on the surface of the tub, apply a neutral cleansing agent to the surface and use a sponge to clean it. Never use a metal brush.
- Do not use dry cleaning detergent directly and do not wash, rinse, or spin laundry contaminated by dry cleaning detergent.
 - This may result in spontaneous combustion or ignition due to heat from the oxidation of the oil.
- Do not use hot water from water cooling/heating devices.
 - This may result in problems with the washer.
- Do not use hot water from water cooling/heating devices.
 - This may result in problems with the washer.

Do not use natural hand-washing soap for the washer.

- If it hardens and accumulates inside the washer, it may cause problems with the product, discoloration, rust, or bad odors.

Do not wash large laundry items such as bedding in the washing net.

- Failing to do so may result in injury due to abnormal vibrations.
- Place smaller items, such as lace socks and lingerie in the washing net.

Do not use hardened detergent.

- If it accumulates inside the washer, it may result in water leakage.

Do not wash throw rugs or doormats.

- If you wash throw rugs or doormats, the sand will accumulate inside the washer. It may result in error such as no draining.



CRITICAL CLEANING INSTRUCTIONS



Do not clean the appliance by spraying water directly onto it.
Do not use benzene, thinner, or alcohol to clean the appliance.

- This may result in discoloration, deformation, damage, electric shock, or fire.

Before cleaning or performing maintenance, unplug the appliance from the wall socket.

- Failing to do so may result in electric shock or fire.

contents

INSTALLING YOUR WASHER

11

- 11 Unpacking your washer
- 11 Overview of your washer
- 12 Electrical
- 12 Grounding
- 12 Water
- 13 Drain facility
- 13 Flooring
- 13 Location considerations
- 13 Alcove or closet installation
- 14 Required Dimensions for Installation
- 15 Important note to installer
- 16 Environment

OPERATING INSTRUCTIONS

17

- 17 Loading your washer
- 17 Getting started

WASHING A LOAD OF LAUNDRY

18

- 18 Overview of the control panel
- 20 Child Lock
- 21 Spin Only Adjustment
- 21 Garment+ 
- 21 My cycle
- 22 Washing clothes using the cycle selector
- 23 Which detergent to use
- 23 Features

MAINTAINING YOUR WASHER

25

- 25 Cleaning the exterior
- 25 Cleaning the interior
- 25 Storing your washer
- 25 Preserving the top cover and the front frame
- 26 Cleaning the dispensers
- 27 Eco Tub Clean

TROUBLESHOOTING

28

- 28 Check these solutions if your washer...
- 30 Information codes

APPENDIX

32

- 32 Fabric care chart
- 33 Cycle chart
- 34 Helping the environment
- 34 Declaration of conformity
- 34 Specification

installing your washer

UNPACKING YOUR WASHER

Unpack your Washer and inspect it for shipping damage. Make sure you have received all the items shown below. If your Washer was damaged during shipping, or you do not have all of the items, contact Samsung Customer Service or your Samsung dealer.

To prevent personal injury or strain, wear protective gloves whenever lifting or carrying the unit.

 Packing materials can be dangerous to children; Keep all packing material (plastic bags, polystyrene, etc.) well out of childrens' reach.

OVERVIEW OF YOUR WASHER

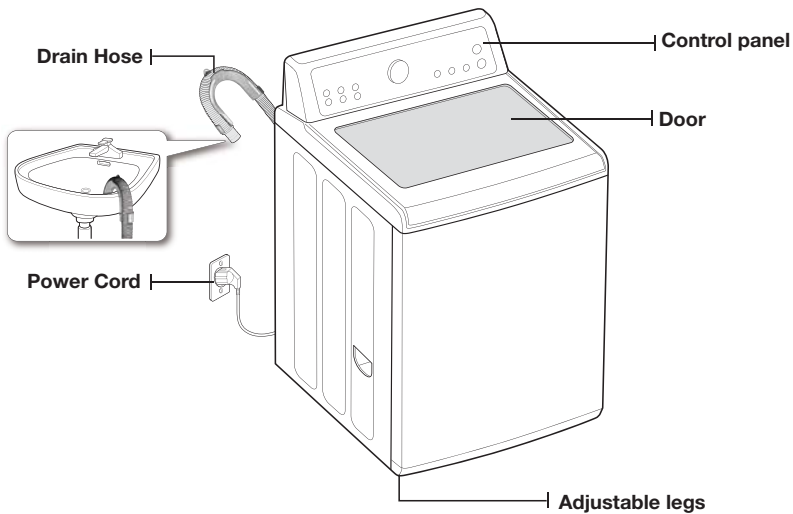

Parts supplied



Hose guide



User manual book

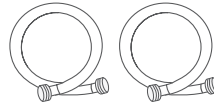

Water supply hoses



Plastic zip hose tie

Tools needed



Pliers



Flat screwdriver

installing your washer

BASIC LOCATION REQUIREMENTS

Electrical

- 220~240V / 50Hz fuse or circuit breaker
- Individual branch circuit serving only your Washer is recommended.
- Your Washer is equipped with a power cord.



NEVER USE AN EXTENSION CORD.

Grounding

ELECTRICAL GROUNDING IS REQUIRED FOR THIS APPLIANCE.

This appliance must be grounded. In the event of malfunction or breakdown, grounding will reduce the risk of electric shock by providing a path of least resistance for electric current.

This appliance is equipped with a power cord having a three-prong grounding plug for use in a properly installed and grounded outlet.

The plug must be plugged into an appropriate outlet that is properly installed and grounded in accordance with all local codes and ordinances.



An improperly connected equipment-grounding conductor can increase the risk of electrical shock. Check with a qualified electrician or serviceman if you are not sure whether the appliance is properly grounded. Do not modify the plug provided with the appliance – if it does not fit the outlet, have a proper outlet installed by a qualified electrician.

IMPORTANT SAFETY PRECAUTIONS

- To prevent unnecessary risk of fire, electrical shock or personal injury, all wiring and grounding must be done in accordance with the National Electrical Code ANSI/FNPA, No. 70 Latest Revision and local codes and ordinances. It is the personal responsibility of the appliance owner to provide adequate electrical service for this appliance.



NEVER CONNECT THE GROUND WIRE TO PLASTIC PLUMBING LINES, GAS LINES, OR HOT WATER PIPES.

Water

To correctly fill your Washer in the proper amount of time, water pressure of 20 to 116psi (137 to 800kPa) is required.

Water pressure less than 20 psi may cause water valve failure, or may not allow the water valve to shut off completely, or may extend the fill time beyond what your Washer controls allow, causing your Washer to turn off. A time limit is built into the controls to prevent flooding in your home if a hose becomes loose.

The water faucets must be within 4 feet/122cm of the back of your Washer to match the inlet hoses provided with your Washer.



Accessory inlet hoses are available in various lengths up to 10 feet/305cm for faucets that are further away from the back of your Washer.

To avoid the possibility of water damage:

- Have water faucets easily accessible
- Turn off faucets when the washer is not in use.
- Periodically check that there is no leakage from the water inlet hose fittings.



CHECK ALL CONNECTIONS AT THE WATER VALVE AND FAUCET FOR LEAKS.

Drain facility

The recommended height of the standpipe is 39 in/ 99 cm. The drain hose must be routed through the drain hose clip to the standpipe. The standpipe must be large enough to accept the outside diameter of the drain hose. The drain hose is attached to the washer at the factory.

Flooring

For best performance, you must install your washer on a solidly constructed floor. Wood floors may need to be reinforced to minimize vibration and/or unbalanced load situations. Carpeting and soft tile surfaces are contributing factors to vibration which can cause your washer to move slightly during the spin cycle.

Never install your washer on a platform or weakly supported structure.

Location considerations

Do not install your washer in areas where water may freeze, since your washer will always retain some water in its water valve, pump, and hose areas. Frozen water can damage the belts, the pump, hoses, and other components.

Alcove or closet installation

MINIMUM CLEARANCES FOR CLOSET AND ALCOVE INSTALLATIONS:

Sides – 1 in / 25 mm

Closet Front – 2 in / 51 mm

Rear – 6 in / 152 mm

TOP - 21 in / 533 mm

If the washer and dryer are installed together, the closet front must have at least a 72 in² (465 cm²) unobstructed air opening. Your washer alone does not require a specific air opening.

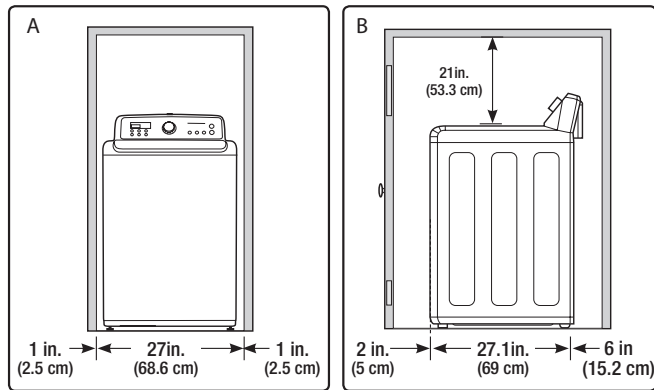

A. Recessed area

B. Side view - closet or confined area

installing your washer

Required Dimensions for Installation

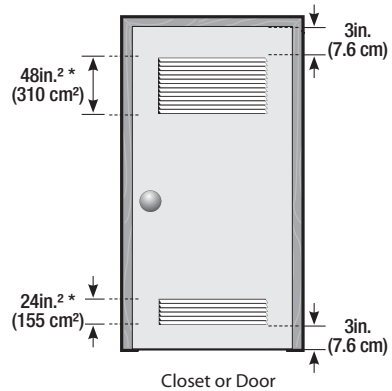
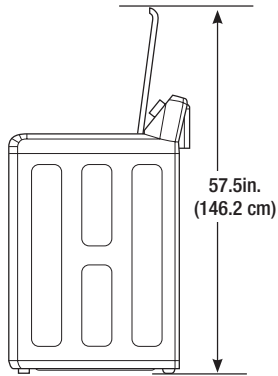
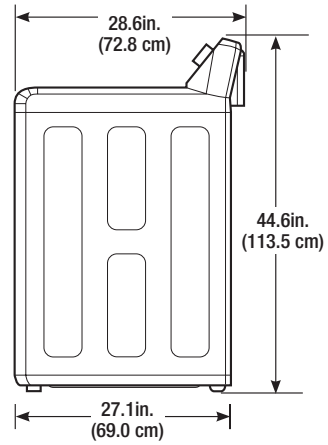
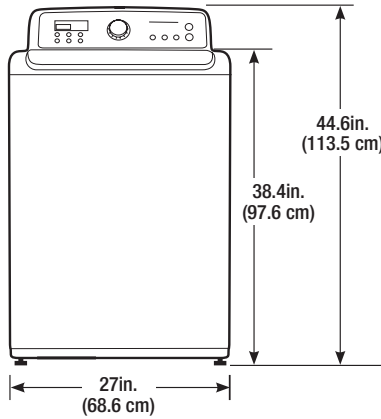

* Required spacing

** External exhaust elbow requires additional space.

IMPORTANT NOTE TO INSTALLER

Please read the following instructions carefully before installing your Washer.

These instructions should be retained for future reference.

We recommend you hire a professional to install this washer.

STEP 1

Selecting a Location



Before you install your washer, make sure the location:

- Has a hard, level surface without carpeting or flooring that may obstruct ventilation.
- Has no dust, oil and detergent etc.
- Is away from direct sunlight
- Has adequate ventilation
- Will not freeze (temperatures are never below 32°F or 0°C)
- Is away from heat sources such as oil or gas
- Provides enough slack for the power cord.
- Doesn't have any carpeting that will obstruct ventilation openings.

STEP 2

Installing your Washer

1. If you use a stand pipe, make sure the connection between the drain hose and the standpipe is NOT airtight.

The standpipe must be at least 39 in or 99 cm high.



You must always exercise caution to avoid collapsing or damaging the drain hose. For best results, the drain hose should not be restricted in any way – by elbows, couplings, or excessive length. For situations where the drain hose cannot be conveniently elevated to at least 39 in or 99 cm, the drain hose must be supported.

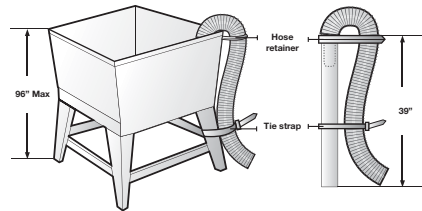

Do not insert the drain hose too far into the stand pipe: 6 - 8 inches, and no more.

installing your washer

2. Check the inlet hoses to ensure a washer is inside the coupling of each fill hose.
Thread the inlet hoses onto the HOT and COLD faucet connections.
On the other end of the hose, check for one rubber washer per hose and attach each fill hose to the water valve. Make sure the hose with Hot printed on it is attached to the HOT faucet. Tighten by hand until snug, then add two-thirds of a turn with pliers.

 For correct water use, connect both HOT and COLD water valves. If either or both are not connected, an "nF" (no fill) error can occur.

3. Turn on the "HOT" and "COLD" water supplies and check all the water valve and the faucet connections for leaks.

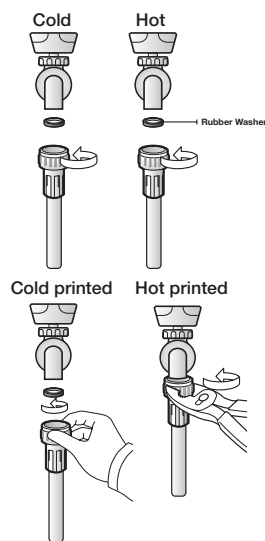

4. Plug the power cord into a 3-Prong, well grounded 220~240V/50Hz approved electrical outlet protected by a comparable circuit breaker.

Your washer is grounded through the third prong of the power cord when plugged into a three-prong grounded receptacle.

5. Slide your washer into position.
6. Level your washer by turning the leveling legs in or out as necessary by hand.

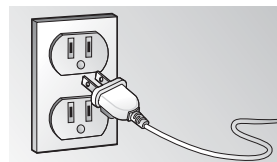

 Your Washer must be level back to front and side to side. Use a carpenter's level on all four corners of your Washer to level it. It's a good idea after the first dozen washes to recheck your washer to ensure it is still level.

ENVIRONMENT

Please dispose of the packaging materials for this product in an "environmentally friendly" manner. For further detail, please contact your local area authority.

operating instructions

LOADING YOUR WASHER

- You can fill the tub with dry, unfolded clothes, but **DO NOT OVERLOAD** the tub, No more than 3/4 full.
- Overloading may reduce washing efficiency, cause excess wear, and possibly cause creasing or wrinkling of the load.
- Wash delicate items such as bras, hosiery, and other lingerie in the Delicates/Hand Wash cycle with similar lightweight items.
- When washing big bulky items or a few smaller items that don't fill the tub completely – a rug, a pillow, stuffed toys, or one or two sweaters, for example – add a few towels to improve spin performance.

 During the spin cycle, the washer may add additional water to redistribute the clothes and correct an unbalance inside the drum.

- When washing heavily soiled loads, do not overload your Washer to ensure good cleaning results.
- To add a forgotten item:
 1. Press the **Start/Pause** button to pause the washer.
 2. Wait for the door to unlock automatically, and then open the door.
 3. Add the item, close the door, and then press the Start/Pause Button. The cycle will resume.

GETTING STARTED

1. Load your Washer.
2. Add liquid detergent only and additives to the dispenser (see pages 23~24).
3. Select the appropriate cycle and options for the load (see pages 18~19).
4. Close the door.
5. Press the Start/Pause Button.
6. The Wash Indicator light illuminates.
7. The estimated cycle time will appear in the display.
The time may fluctuate to indicate the time remaining in the cycle better.

 The actual time required for a cycle may differ from the estimated time in the display depending on the water pressure, water temperature, detergent, and laundry.

8. Before your washer starts to fill, it will make a series of clicking noises to check the door lock and do a quick drain.

- 
- When the cycle is complete, the Door Lock light will go out and “End” will appear in the display.
 - Pressing the Power button cancels the cycle and stops your washer.
 - The Wash, Rinse ,and Spin indicator lights will illuminate during those portions of the cycle.

washing a load of laundry

OVERVIEW OF THE CONTROL PANEL

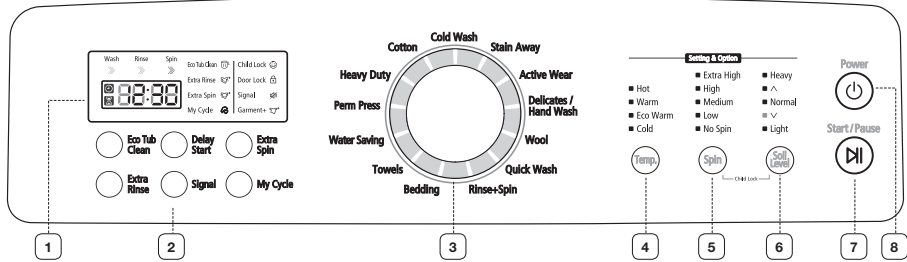

<p>1 Display</p>	<p>Provides instructions and diagnostics while keeping you updated on the cycle status and time remaining.</p>
<p>2 Select Cycle Option</p>	<p>Press these buttons to select different cycle options.</p> <p>Eco Tub Clean - Use to clean dirt and bacteria from the drum. Regular use (after every 21 washes) is recommended. No detergent or bleach is needed (see page 27).</p> <p>Delay Start - Delay the start of any cycle for up to 24 hours in one-hour increments. Displayed hour indicates the time the wash will be started.</p> <p>Extra Spin - Add additional spin time to remove more water from loads.</p> <p>Extra Rinse - Add an additional rinse at the end of the cycle to more thoroughly remove laundry additives and perfumes.</p> <p>Signal - Press to turn the signal (chime) on or off.</p> <p>My Cycle - Create and/or use a cycle you create with customized temperature, spin, soil level, option, etc.</p>
<p>3 Cycle Selector</p>	<p>Select the appropriate cycle for the type of load. The cycle you select determines the tumble pattern and spin speed for the cycle.</p> <p> To minimize wrinkling of laundry, select the Perm Press cycle.</p> <p>Cotton - For most fabrics including cottons, linens, and normally soiled garments.</p> <p>Heavy Duty - For sturdy, colorfast fabrics and heavily soiled garments.</p> <p>Perm Press - For wash-and-wear, synthetic fabrics, and lightly to normally soiled garments.</p> <p>Water Saving - This is a specifically designed course that enables you to wash laundry effectively with low amounts of water. Water Saving, Warm water temperature, Extra High spin, Normal soil level, Extra Spin is suitable for a normally soiled cotton load.</p> <p>Towels - For bath towels, washcloths, and mats.</p> <p>Bedding - For bulky items such as blankets and sheets. When you are washing comforters, use liquid detergent.</p> <p>Cold Wash - Provides useful, gentle, daily care for normally and lightly soiled laundry by using only cold water.</p> <p>Stain Away - For stained clothes. The Stain Away cycle provides outstanding stain removal performance with the gentlest care and frees you from the need to pre-treat stains.</p>

	<p>Active Wear - Use this cycle to wash exercise wear such as sports jerseys, training pants, shirts/tops and other performance clothing. This cycle provides effective soil removal with gentle action for special fabric care.</p> <p>Delicates/Hand Wash - For sheer fabrics, bras, lingerie, silks, and other handwash-only fabrics. For best results, use liquid detergent.</p> <p>Wool - For machine-washable wool. Loads should be under 8 pounds. For best results, we recommend a load of 4.4 pounds or less.</p> <ul style="list-style-type: none"> The Wool cycle washes laundry by moving the wash drum horizontally to maintain the characteristics of the wool fibers and to prevent damage to the cloth. It then stops for a while to allow the laundry to soak in the water. This pause in the operation of the Wool cycle is normal. We recommend you use a neutral detergent to prevent damage to the cloth and to improve the washing results. <p>Quick Wash - For lightly soiled garments needed quickly.</p> <p>Rinse + Spin - Use for loads that need rinsing only or to add rinse-added fabric softener to a load.</p>
<p>4 Temperature selection button</p>	<p>Press the button repeatedly to cycle through the different water temperature options.</p> <p>Hot - Whites and heavily soiled, colorfast items.</p> <p>Warm - Colorfast items.</p> <p>Eco Warm - Moderately soiled, colorfast items; most wrinkle-free items.</p> <p>Cold - Brightly colored, very lightly soiled items.</p>
<p>5 Spin selection button</p>	<p>Press the button repeatedly to cycle through the different spin speed options.</p> <p>Extra High - Removes more water from loads during spin.</p> <p> To minimize wrinkling of wrinkle-free and no-iron fabrics, DO NOT use the Extra High spin option for these loads, nor overload your Washer.</p> <p>High - Use for underwear, t-shirts, jeans, and sturdy cottons.</p> <p>Medium - Use for jeans, wrinkle-free or wash-and-wear items, and synthetics.</p> <p>Low - Use for delicate items needing a slow spin speed.</p> <p>No Spin - Drains your Washer without spinning. Use for extremely delicate items that cannot tolerate any spin.</p>
<p>6 Soil Level selection button</p>	<p>Press the button to select the soil level/washing time. (Normal → ▲ → Heavy → Light → ▼)</p> <p>Heavy - For heavily soiled loads.</p> <p>▲</p> <p>Normal - For moderately soiled loads. This setting is best for most loads.</p> <p>▼</p> <p>Light - For lightly soiled loads.</p>
<p>7 Start/Pause selection button</p>	<p>Press to pause and restart cycles.</p>
<p>8 Power button</p>	<p>Press once to turn your washer on. Press again to turn your washer off. If the washer is left on for more than 10 minutes without any buttons being touched, the power automatically turns off.</p>

washing a load of laundry

Child Lock

Child Lock prevents children from playing with your washer.

Activating the Child Lock function

Press and hold the **Spin** and **Soil Level** buttons simultaneously for approximately 3 seconds.

- When you activate the Child Lock function, the “Child Lock [🔒]” lamp blinks.

Using the Child Lock function

If the door is opened when the Child Lock function is on, “ds” is displayed and an alarm sounds.

- If the door is closed while “ds” is displayed, the alarm sound stops and the information code turns from “ds” to “Child Lock [🔒]”.
- 30 seconds after the control panel displays “ds”, the washer performs a compulsory drain.
- Even if the power is off, if Child Lock is on and the door is opened for 30 seconds, the washer displays the “Child Lock [🔒]” code and performs a compulsory drain.
- After the compulsory drain, the “CL” code display blinks at 1 second intervals and the product enters the “Child Lock [🔒]” mode. (When the product is in the “Child Lock [🔒]” mode, only the Power button works.)
- To cancel the “Child Lock [🔒]” mode, you need to turn the power off and then on again.
- To cancel the “ds” mode, deactivate the Child Lock function. To deactivate the Child Lock function, press and hold the Spin and the Soil Level buttons simultaneously for at least 3 seconds.



Adding laundry when Child Lock is on

- To add laundry, deactivate the Child Lock function. To deactivate the Child Lock function, press and hold the Spin and the Soil Level buttons simultaneously for at least 3 seconds. See “Pause Option” on page 22 for additional details.

Deactivating the Child Lock function

Press and hold both the **Spin** and **Soil Level** buttons simultaneously for approximately 3 seconds.

- When you deactivate the Child Lock function, the “Child Lock [🔒]” lamp is turned off.
- The Child Lock function prevents children or the infirm from accidentally operating the washer and injuring themselves.



WARNING

- If a child enters the washing machine, the child may become trapped and suffocate.



CAUTION

- Once you have activated the Child Lock function, it continues working even if the power is turned off.
- Opening the door by force can result in injury or damage to the product.



- To add laundry after you have activated the Child Lock function, you must first pause or deactivate the Child Lock function.

Spin Only Adjustment

If you press the **Power** button, and then press and hold the **Spin** button for 2 seconds, the spin time is displayed on the display panel.

You can then change the spin level independently of any other setting by pressing the **Spin** button repeatedly until the spin level you want (High, Medium, etc.) is selected on the control panel. Then, press the **Start/Pause** button.

 Make a Spin Only adjustment before you select a cycle. If you have selected a cycle, you can only select the corresponding spin level.

Garment+

You can add or take out laundry items even after the wash has started, as long as the “**Garment+**” light is on. Pushing the **Start/Pause** button unlocks the door, unless the water is too hot or there is too much water in your Washer. If you open the door and want to continue the wash cycle, close the door, and then press the **Start/Pause** button.

 If you have activated Child Lock, you must deactivate it first. See page 20.

My cycle

My Cycle lets you create a custom wash cycle (with custom temperature, spin, soil level, etc.) and activate your custom wash cycle with one-button convenience.

Creating a custom wash cycle

To create a custom wash cycle, follow these steps:

1. Press the Power button, and then open the door.
 2. Load the washer with clothes.
 3. Add detergent (and softener and/or bleach if needed) to the appropriate compartments, and then close the door.
 4. Press the My Cycle button. The My Cycle indicator light illuminates.
 5. Select the cycle you want on the Cycle Selector dial.
 6. Set the options available for the cycle you selected.
-  See pages 33 for the options available with each cycle.
7. Push the Start/Pause button to start the cycle. The next time you press My Cycle, the washer will return to these settings automatically.

 To program in “My Cycle” settings, the washer needs to complete an entire wash cycle. If for any reason the wash cycle is interrupted and the washer does not finish the cycle, it will not program in the settings for later use.

 You can change the “My Cycle” settings by repeating the process above. The washer uses the latest programmed settings whenever you choose “My Cycle”.

Running your custom cycle using My Cycle

To run your custom cycle, follow these steps:

1. Press the Power button, and then open the door.
2. Load the washer with clothes.
3. Add detergent (and softener and/or bleach if needed) to the appropriate compartments, and then close the door.
4. Press the My Cycle button. The My Cycle indicator light illuminates and the cycle begins.

washing a load of laundry

Washing clothes using the cycle selector

Your new washing machine makes washing clothes easy, using Samsung's "Fuzzy Control" automatic control system. When you select a wash program, the machine will set the correct temperature, washing time, and washing speed.

1. Press the **Power** button.
2. Open the door.
3. Load the articles of clothing one at a time loosely into the drum, without overfilling it.
4. Add liquid detergent only, softener, and/or bleach (if necessary) to the appropriate compartments. See pages 23~24.
5. Close the door.
6. Use the Cycle Selector to select the appropriate cycle according to the type of material: Cotton, Heavy Duty, Perm Press, Water Saving, Towels, Bedding, Cold Wash, Stain Away, Active Wear, Delicates/Hand Wash, Wool, Quick Wash, Rinse + Spin. The relevant indicators will illuminate on the control panel.
7. At this time, you can control the wash temperature, the number of rinse cycles, the spinning speed, and the delay time by pressing the appropriate option button.
8. Press the Start/Pause button on the Cycle Selector and the wash will begin. The process indicator will light up and the remaining time for the cycle will appear in the display.

Pause Option

When the Garment + LED is on, you can add laundry items to or remove laundry items from the wash.

To remove or add laundry items when the Garment + LED is on, follow these steps:

1. Press the Start/Pause button to unlock the door.
2. Remove or add laundry items.
3. Close the door, and then press the Start/Pause button to restart the wash.

 If you have Child Lock on, you must deactivate it first. See page 21.

When the cycle is finished:

After the total cycle has finished, the power will turn off automatically.

1. Open the door.
2. Remove laundry.

WHICH DETERGENT TO USE

The type of detergent you should use is based on the type of fabric (cotton, synthetic, delicate items, wool), colour, wash temperature, and degree of soiling. Always use "low suds" laundry detergent, which is designed for automatic washing machines.

Follow the detergent manufacturer's recommendations based on the weight of the laundry, the degree of soiling, and the hardness of the water in your area. If you do not know how hard your water is, enquire at your local water authority.

- ☞ Do not use detergent that has hardened or solidified as the detergent may remain in the rinse cycle. It may cause your washing machine to not rinse properly or result in the overflow becoming blocked.

Detergent use

Your Washer is designed to use high efficiency (HE) detergents.

- For best cleaning results, use a high efficiency detergents. High efficiency detergents contain suds suppressors that reduce or eliminate suds. When fewer suds are produced, the load tumbles more efficiently and cleaning is maximized.
- ☞ Reducing the amount of detergent may reduce the quality of cleaning. It is important to pre-treat stains, sort carefully by color and soil level, and avoid overloading.



FEATURES

Automatic dispenser

Your Washer has separate compartments for dispensing detergent and colour-safe bleach and fabric softener. Add all laundry additives to their respective compartments before starting your Washer.

The automatic dispenser **MUST ALWAYS** be in place before you start your Washer.

DO NOT open the automatic dispenser when your washer is running.

- ☞ • Never exceed the manufacturer's recommendations when adding detergent.
- This compartment holds liquid detergent for the main wash cycle, which is added to the load at the beginning of the cycle.

To add detergent to the automatic dispenser:

1. Open the dispenser drawer.
2. Load the recommended amount of liquid detergent into the detergent compartment before you start your wash.
3. Close the drawer slowly and smoothly to avoid spilling, splashing, or premature dispensing of the contents.

- ☞ It is normal for a small amount of water to remain in the dispenser compartments at the end of the cycle.

- ☞ Do not put chlorine bleach in the dispenser drawer.

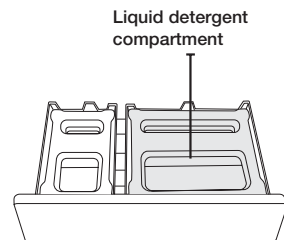

washing a load of laundry

Loading the Liquid detergent compartment

1. Pour the recommended amount of laundry detergent directly into the detergent compartment before starting your Washer.
2. If you are using color-safe bleach, add it with the detergent to the detergent compartment.

 When adding color-safe bleach with detergent, it is best if both laundry products are in the same form – liquid.

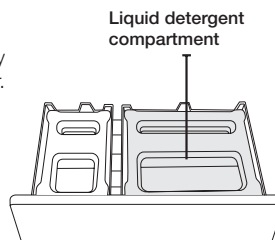

Loading the Bleach compartment

(Liquid chlorine bleach only)

1. Add chlorine bleach to the bleach compartment.
DO NOT exceed the MAX FILL line.
 - Avoid splashing or over-filling the compartment.
 - Your Washer automatically dispenses bleach into the tub at the appropriate time.
2. The dispenser automatically dilutes liquid chlorine bleach before it reaches the wash load.



- Never pour undiluted liquid chlorine bleach directly onto the load or into the tub. It is a powerful chemical and can cause fabric damage, such as weakening of the fibers or color loss, if not used properly.
- If you prefer to use color-safe, non-chlorine bleach, add it to the appropriate detergent compartment. DO NOT pour color-safe bleach into the Bleach compartment.

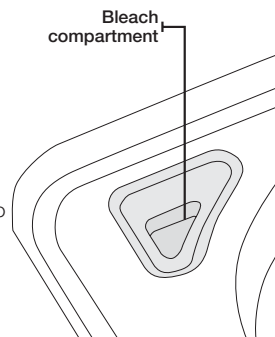

Loading the Fabric softener compartment

1. Pour the recommended amount of liquid fabric softener into the softener compartment. For smaller loads, use less than one capful.
2. Dilute the fabric softener with water until it reaches MAX FILL in the compartment.
3. The dispenser automatically releases liquid fabric softener at the proper time during the rinse cycle.



- Use the softener compartment ONLY for liquid fabric softeners.
- DO NOT use the Downy Ball* in the fabric softener compartment with this Washer. It will not add fabric softener at the appropriate time. Use the detergent Compartment.
- Do not use liquid fabric softener that is too sticky as it may not mix with the water sufficiently.
- * Brand names are trademarks of their respective manufacturers.

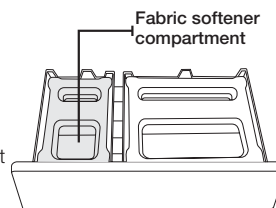

maintaining your washer

CLEANING THE EXTERIOR

Turn off the water faucets after finishing the day's washing.

This will shut off the water supply to your Washer and prevent the unlikely possibility of damage from escaping water. Leave the door open to allow the inside of your Washer to dry out.

Use a soft cloth to wipe up all detergent, bleach or other spills as they occur.

Clean the following as recommended:

Control Panel – Clean with a soft, damp cloth. Do not use abrasive powders or cleaning pads. Do not spray cleaners directly on the panel.

CLEANING THE INTERIOR

Clean the interior of your Washer periodically to remove any dirt, soil, odor, mold, mildew, or bacterial residue that may remain in your Washer as a result of washing clothes.

Failure to follow these instructions may result in unpleasant conditions, including odors and/or permanent stains on your Washer or laundry.

Hard water deposits may be removed, if needed. Use cleaners labeled "Washer safe".

STORING YOUR WASHER

Washers can be damaged if water is not removed from hoses and internal components before storage. Prepare your Washer for storage as follows:

- Select the Quick Wash cycle and add bleach to the automatic dispenser. Run your Washer through the cycle without a load.
- Turn the water faucets off and disconnect the inlet hoses.
- Unplug your Washer from the electrical outlet and leave your Washer door open to let air circulate inside the tumbler.
- If your Washer has been stored in below-freezing temperatures, allow time for any leftover water in your Washer to thaw out before use.

PRESERVING THE TOP COVER AND THE FRONT FRAME

Do not place any heavy or sharp objects or a detergent box on the washing machine. They can scratch or damage the top cover of the unit.

-  Since the entire washing machine has a high-gloss finish, the surface can be scratched or damaged. Avoid scratching or damaging the surface when using the washing machine.

maintaining your washer

CLEANING THE DISPENSERS

The automatic dispenser may need to be cleaned periodically due to laundry additive buildup.

1. Pull the dispenser drawer straight back until it stops.

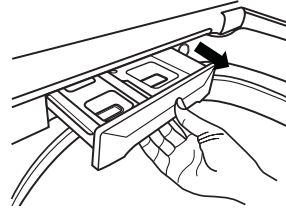

2. Tilt the dispenser drawer upward and remove it.

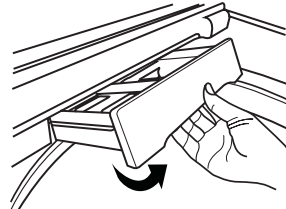

3. Remove the inserts from the 2 compartments. Rinse the inserts and the drawer with warm water to remove traces of accumulated laundry products.

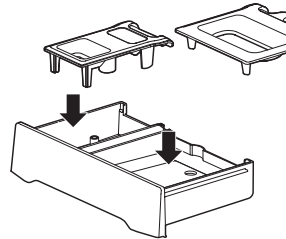

4. To clean the drawer opening, use a small, non-metal brush to clean the recess. Remove all residue from the upper and lower parts of the recess.

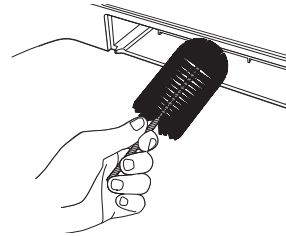

5. Return the inserts to the proper compartments and replace the drawer. by placing the dispenser drawer rail ② on top of the compartment rail ①, and then pushing the drawer in firmly

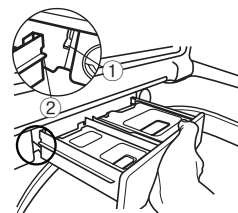

ECO TUB CLEAN

Eco Tub Clean is a self-cleaning cycle that removes mold that may occur inside the washing machine.

1. Press the **Power** button.
2. Press the **Eco Tub Clean** button.
 - Once the Eco Tub Clean button is pressed, the only function that can be set is Delay Start.
3. Press the **Start/Pause** button.
 - If you press the Start/Pause button, Eco Tub Clean begins.



- Using Eco Tub Clean, you can clean the drum without using a cleansing agent.
- Never use Eco Tub Clean when laundry is in the washing machine. This may cause damage to the laundry or a problem with the washing machine.



The Eco Tub Clean Auto Indicator Function

- If the “Eco Tub Clean” button is lit after a wash, it indicates that tub (drum) cleaning is required. In this case, remove the laundry from the washing machine, turn the power on, and clean the drum by running Eco Tub Clean.
- If you do not run Eco Tub Clean, the “Eco Tub Clean” indicator turns off. However, the “Eco Tub Clean” indicator will light again after two washes. Not running Eco Tub Clean at this point will not cause a problem with the washing machine.
- Although the Eco Tub Clean Auto Indicator appears once a month or so, the frequency may differ depending on the number of times the washing machine is used.

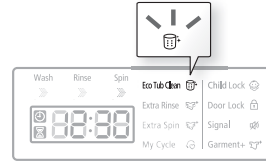

troubleshooting

CHECK THESE SOLUTIONS IF YOUR WASHER...

PROBLEM	SOLUTION
Will not start.	<ul style="list-style-type: none">• Make sure the door is closed.• Make sure your Washer is plugged in.• Make sure the water source faucets are open.• Make sure to press the Start/Pause Button to start your Washer.• Make sure Child Lock is not activated. See page 21.• Before your Washer starts to fill, it will make a series of clicking noises to check the door lock and do a quick drain.• Check the fuse or reset the circuit breaker
Has no water or not enough water..	<ul style="list-style-type: none">• Turn both faucets on fully.• Straighten the water inlet hoses.• Disconnect hoses and clean the screens. Hose filter screens may be clogged.• Open and close the door, then press the Start/Pause Button.
Has detergent remaining in the automatic dispenser after the wash cycle is complete.	<ul style="list-style-type: none">• Make sure your Washer is running with sufficient water pressure.
Vibrates or is too noisy.	<ul style="list-style-type: none">• Make sure your Washer is set on a level surface. If the surface is not level, adjust your Washer feet to level the appliance.• Make sure that the shipping bolts are removed.• Make sure your Washer is not touching any other object.• Make sure the laundry load is balanced.
Stops	<ul style="list-style-type: none">• Plug the power cord into a live electrical outlet.• Check the fuse or reset the circuit breaker.• Close the door and press the Start/Pause Button to start your Washer. For your safety, your Washer will not spin unless the door is closed.• Before your Washer starts to fill, it will make a series of clicking noises to check the door lock and do a quick drain.• There may be a pause or soak period in the cycle. Wait and it may start.• Check the screens on the inlet hoses at the faucets for obstructions. Clean the screens periodically.



PROBLEM	SOLUTION
Fills with the wrong temperature water.	<ul style="list-style-type: none"> • Turn both faucets on fully. • Make sure the temperature selection is correct. • Make sure the hoses are connected to the correct faucets. Flush water lines. • Disconnect the hoses and clean the screens. The hose filter screens may be plugged. • As your Washer is filling, the water temperature may change as the automatic temperature control feature checks incoming water temperature. This is normal. • While your Washer is filling, you may notice just hot and/or just cold water going through the dispenser when you have selected cold or warm wash temperatures. This is a normal function of the automatic temperature control feature as your Washer determines the temperature of the water.
Door locked or will not open.	<ul style="list-style-type: none"> • Press the Start/Pause Button to stop your Washer. • It may take a few moments for the door lock mechanism to disengage.
Does not drain and/or spin.	<ul style="list-style-type: none"> • Check the fuse or reset the circuit breaker. • Straighten the drain hoses. Eliminate kinked hoses. If there is a drain restriction, call for service. • Close the door and press the Start/Pause Button. For your safety, your Washer will not spin unless the door is closed.
Load is too wet at the end of the cycle.	<ul style="list-style-type: none"> • Use the High or Extra High spin speed. • Use high efficiency detergent to reduce over-sudsing. • The Load is too small. Very small loads (one or two items) may become unbalanced and not spin out completely.
Leaks water.	<ul style="list-style-type: none"> • Make sure all hose connections are tight. • Make sure the end of the drain hose is correctly inserted and secured to the drainage system. • Avoid overloading. • Use high efficiency detergent to prevent over-sudsing.
Has excessive suds.	<ul style="list-style-type: none"> • Use high efficiency detergent to prevent over-sudsing. • Reduce the detergent amount for soft water, small or lightly soiled loads. • Non-HE detergent is NOT recommended.

troubleshooting

INFORMATION CODES

The Washer may display information codes to help you understand what is occurring with your Washer better.

CODE SYMBOL	MEANING	SOLUTION
dc	Unbalanced load prevented your Washer from spinning.	Redistribute the load, press the Start/Pause Button.
ds	Door is open when Washer is running.	Close the door tightly and restart the cycle. If the code reappears, call for service.
FL	Your Washer failed to lock the door.	Close the door tightly and restart the cycle. If the code reappears, call for service.
HE	Water temperature control problem. (Heater Control problem)	Call for service.
LE	Your Washer has tried to fill but has not reached the proper water level.	Call for service.
LO	The door will not unlock.	Make sure the door is firmly closed. Push the Power button to turn off your Washer, then turn it on again. If the code reappears, call for service.
3E	Motor not running properly.	Restart the cycle pressing the Start/Pause Button. If the code reappears, call for service.
nd	Your washer is not draining. It can also mean that the unit senses a small clog while draining.	Do the following: 1) Turn off the unit and turn it on again. 2) Select only the Spin Cycle. 3) Press the Start/Pause to drain the water. If it still does not drain, call for service.
nF	Your Washer has tried to fill but was unsuccessful.	Make sure the water faucets are open all the way. Check for kinked hoses. Check the inlet screens on the fill hoses. If you use a Flood Safety Device, then please remove the device and connect the water hoses directly to the unit.
	Check if the hot water supply hose is connected.	You must connect the hot water supply hose because hot water is supplied by the Auto Temperature Control (A.T.C.) function.
nFi	The hot/cold water hose connection is not correct.	Please connect the hot/cold water hose connection correctly.
OE	A fault is detected in the water level sensor.	Call for service
E2	Jammed Key.	Call for service
EE1	Temperature sensor problem.	Restart the cycle. If the code reappears, call for service.



































	<p>High current detected.</p>	<p>Restart the cycle. If the code reappears, call for service.</p>
	<p>Too much suds has been detected during the washing cycle.</p> <p>The unit pauses until the suds dissapate. Then, the unit will go back into operation.</p> <p>When it finishes washing, End and the SUdS code will blink in turn.</p>	<p>To prevent, reduce the amount of detergent.</p>

For any codes not listed above, call contact Samsung Customer Service or your Samsung dealer.

appendix

FABRIC CARE CHART

The following symbols provide garment care direction. The Clothing care labels include symbols for washing, bleaching, drying and ironing, or dry cleaning when necessary. The use of symbols ensures consistency among garment manufacturers of domestic and imported items. Follow care label directions to maximize garment life and reduce laundering problems.

Wash Cycle		Special Instructions		Warning Symbols for Laundering	
	Normal		Line Dry/ Hang to Dry		Do Not Wash
	Permanent Press / Wrinkle Resistant / Wrinkle Control		Drip Dry		Do Not Wring
	Gentle/Delicates		Dry Flat		Do Not Bleach
	Hand Wash	Heat Setting			Do Not Tumble Dry
Water Temperature**			High		No Steam (added to iron)
	Hot		Medium		Do Not Iron
	Warm		Low	Dryclean	
	Cold		Any Heat		Dry Clean
Bleach			No Heat/Air		Do Not Dry Clean
	Any Bleach (when needed)	Iron-Dry or Steam Temperatures			Line Dry/ Hang to Dry
	Only Non-Chlorine (color-safe) Bleach (when needed)		High		Drip Dry
	Tumble Dry Cycle		Medium		Dry Flat
Normal			Low		For machine-washable wool. Loads should be under 8 pounds.
	Permanent Press/ Wrinkle Resistant/ Wrinkle Control				
	Gentle/ Delicates				

** The dot symbols represent appropriate wash water temperatures for various items. The temperature range for Hot is 105° - 125° F/ 41° - 52°C, for Warm 85° - 105° F/29° - 41° C and for Cold 60° - 85° F/16° - 29° C. (Wash water temperature must be a minimum of 60° F/16°C for detergent activation and effective cleaning.) The clothes Washer can not ensure these temperatures because the actual temperature of the water entering your Washer depends on water heater settings and regional water supply temperatures. For example, cold water entering the home during winter may be 40° F/4° C which is too cold for effective cleaning. In this situation, you will need to adjust the water temperature by selecting a warm setting, adding some hot water to the MAX FILL line, or using your Washer's heating option, if available.

CYCLE CHART

Use this chart to set the best cycle and options for your laundry.

WA5471*

(●: factory setting, ●: selectable)

	Functions													
	Temp				Spin					Soil Level				
	Hot	Warm	Eco Warm	Cold	Extra High	High	Medium	Low	No Spin	Heavy	▲	Normal	▼	Light
Cotton	●	●	●	●	●	●	●	●	●	●	●	●	●	●
Heavy Duty	●	●	●	●	●	●	●	●	●	●	●	●	●	●
Perm Press		●	●	●		●	●	●	●	●	●	●	●	●
Water Saving	●	●	●	●	●	●	●	●	●			●	●	●
Towels	●	●	●	●	●	●	●		●	●	●	●	●	●
Bedding	●	●	●	●		●	●	●	●	●	●	●	●	●
Rinse + Spin				●	●	●	●	●						
Quick Wash		●	●	●	●	●	●	●	●	●	●	●	●	●
Wool		●		●				●	●					●
Delicates/Hand Wash		●	●	●			●	●	●	●	●	●	●	●
Active Wear		●	●	●		●	●	●	●	●	●	●	●	●
Stain Away	●	●	●		●	●	●	●	●	●	●	●	●	●
Cold Wash			●	●	●	●	●	●	●			●	●	●
Eco Tub Clean	●						●							

	Options					
	Eco Tub Clean	Delay Start	Extra Spin	Extra Rinse	Signal	My Cycle
Cotton	TUB CLEAN COURSE	●	●	●	●	●
Heavy Duty		●	●	●	●	●
Perm Press		●	●	●	●	●
Water Saving		●	●	●	●	●
Towels		●	●	●	●	●
Bedding		●	●	●	●	●
Rinse + Spin		●	●	●	●	●
Quick Wash		●		●	●	●
Wool		●			●	●
Delicates/Hand Wash		●		●	●	●
Active Wear		●		●	●	●
Stain Away		●		●	●	●
Cold Wash		●	●	●	●	●
Eco Tub Clean		●			●	●

appendix

HELPING THE ENVIRONMENT

- Your Washer is manufactured from recyclable materials. If you decide to dispose of it, please observe local waste disposal regulations. Cut off the power cord so that the appliance cannot be connected to a power source. Remove the door so that animals and small children cannot get trapped inside the appliance.
- Do not exceed the detergent quantities recommended in the detergent manufacturers' instructions.
- Use stain removal products and bleaches before the wash cycle only when necessary.
- Save water and electricity by only washing full loads (the exact amount depends upon the program used).

DECLARATION OF CONFORMITY

This appliance complies with European safety standards, EC directive 93/68 and EN Standard 60335.

SPECIFICATION

TYPE	FRONT LOADING WASHER	
DIMENSIONS	Div	Inches (mm)
	A. Height	44.6" (1135)
	B. Width	27" (686)
	C. Height with door open	57.5" (1462)
	D. Depth	28.6" (728)

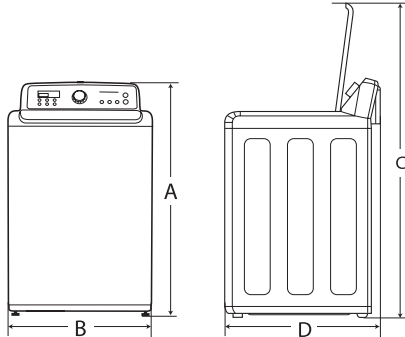

WATER PRESSURE		20-116psi (137-800kPa)	
WEIGHT		68kg (152.1 lb)	
WATER VOLUME		102.9 ℓ	
POWER CONSUMPTION	WASHING	220 V	700W
	SPIN	220 V	400W
	DRAIN	220 V	80W
SPIN REVOLUTION	WA5471*	1100 rpm	

The appearance and specifications of the product are subject to change without prior notice for purposes of product enhancement.

memo

06 appendix



QUESTIONS OR COMMENTS?

Country	CALL	OR VISIT US ONLINE AT
AUSTRALIA	1300 362 603	www.samsung.com

Code No. DC68-03050B_EN