

Fisher & Paykel

Clothes washer

**Installation instructions
and User guide**

NZ AU PAC

Intelligence working for you

smart drive[™]

75 years of laundry experience has led to the development of one of the world's most advanced wash systems, the *Smart Drive*[™].

Unlike conventional machines, *Smart Drive*[™] clothes washers use intelligence to adapt the wash action and water levels to save on water and electricity use; making it kinder on your wallet and the environment.

Intelligent electronics

A powerful microprocessor controls every aspect of the *Smart Drive*[™], allowing it to continually monitor and respond to each wash. It contains over 10,000 lines of instructions in its 'brain' – the result of many years of testing and fine-tuning, to give you the best possible performance.

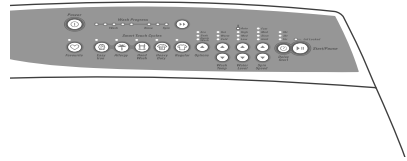

Direct drive motor

Our revolutionary direct drive motor is capable of infinite wash actions, continuously adjusting its speed to the movement of your clothes, removing dirt while caring for the fabric, delivering the ultimate wash.

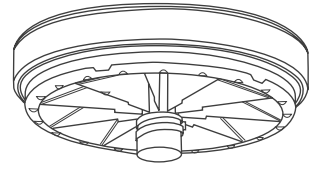

Reliability

The *Smart Drive*[™] has no mechanical brake, pulleys or gears, which means fewer moving parts and greater reliability.

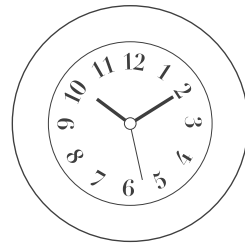

Saves time

With a top spin speed of 1000 rpm, *Smart Drive*[™] reduces clothes drying time by up to 30%.

Energy conservation

The unique wash action means a typical load uses only the same amount of electricity as a 100-watt light bulb left on for an hour.

Eco

Designed to make every drop count, using up to 25% less water than a traditional rinse.



Installation Instructions	2
Getting started	
Before you do your first wash	5
Using your EXCELLENCE washer	6
Using your PRIDE washer	8
Lid lock	10
Wash cycles and options	
Wash cycles and options	11
Wash options and advancing the cycle	12
Water levels	13
Saving water & time – ECO & QUICK WASH options	14
SOAK, SPIN HOLD, DELAY START	15
Washing bulky items, Washing woollens	16
FAVOURITE cycle	17
Customising the wash cycles	18
Before you wash	
Sorting, Loading	19
Detergent	20
Fabric softener, Scrud	21
Changing pre-set options	
Option adjustment mode	22
Wash temperatures, Rinse options	24
CONTROLLED COLD, End of cycle beeps, AUTO water level	25
Out of balance recovery routine	26
Machine information	
Specifications	26
Cleaning your <i>Smart Drive</i> ™	27
Products that might damage your <i>Smart Drive</i> ™	28
<i>Smart Drive</i> ™ sounds and beeps, Automatic lint system	28
Saving water	29
Problem solving	
If your <i>Smart Drive</i> ™ beeps for help	31
Operating problems	33
Wash problems	34
Manufacturer's Warranty	36
Customer Care	37

Important!

SAVE THESE INSTRUCTIONS

The models shown in this User Guide may not be available in all markets and are subject to change at any time. For current details about model and specification availability in your country, please visit our local website listed on the back cover or contact your local Fisher & Paykel dealer.



2 Installation instructions

Unpacking

To ensure the best performance from your new *Smart Drive™* please follow the instructions below.

Removing the packaging

- 1 Remove the outer packaging.
- 2 Tilt the machine backwards and walk it off the bottom packer one foot at a time.
- 3 Remove the bottom packer from under the machine by pulling it out the front.
- 4 Lift the lid and remove the bowl packer from the bowl.
- 5 Remove the hoses and accessories.
- 6 Keep the bottom packer and bowl packer in case they are required for future transit.

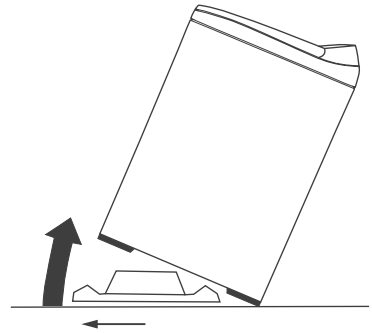

Fig.1 Tilt washer backwards to remove packer

Important!

Please ensure that the bottom packer has been removed before operating your machine.

Location

Your washer must be installed on a level surface, and not on any textured floor coverings (eg carpet, rugs) to ensure that the opening at the bottom of the machine is not obstructed.

In your clothes washer you will find:

- 4 rubber inserts for the levelling feet (joined together).
- 1 hose guide.
- 2 inlet hoses.

Drain hose

- 1 Carefully pull the drain hose out from the back of the machine by pulling the exposed part of the hose downward and outward.
- 2 To guide the drain hose over the tub or standpipe the hose guide MUST be fitted to the drain hose.

To prevent syphoning:

The drain hose should not extend more than 20 mm from the end of the guide.

The height of the standpipe or tub should be between 850 – 1200 mm.

The drain hose can be trimmed to length.

- 3 Place the drain hose in the tub or standpipe.

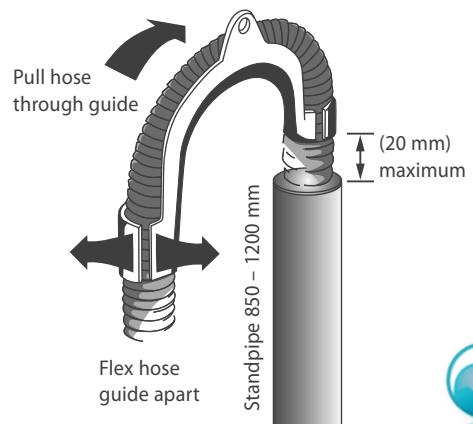

Fig.2 Fitting the drain hose guide



Inlet hoses

- 1 Connect the straight ends of the inlet hoses to the taps. There are washers fitted in both ends.
- 2 Connect the elbow ends of the inlet hoses to the machine inlet valves. Inlet valves are marked on the back of the machine
 H=Hot C=Cold
- 3 Ensure you have correctly connected hot to hot, and cold to cold.

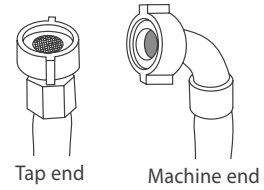

Fig.3 Inlet hose ends

Cold supply only:

If you only have a cold water supply, an inlet valve cap (blanking cap) **MUST** be connected to the hot inlet valve. The cap prevents water leaking out of the hot valve. The cap is available from your Fisher & Paykel Dealer or Authorised Repairer, Part No. 388491. This appliance incorporates backflow protection complying with AS3500.1. No further backflow protection is required for connection to the water supply.

Levelling

It is **IMPORTANT** to level the machine to ensure even spin performance.

- 1 Separate the four rubber foot inserts from the moulding and fit into the feet on the base of the machine.
- 2 Move the machine to its final position (we suggest a minimum clearance of 20 mm each side).
- 3 Adjust the feet (wind down) so the machine is level and cannot rock.

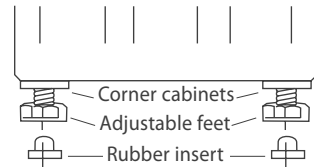

Fig.4 Adjusting levelling feet

To check if your machine is level:

Look down on the wash bowl and make sure it sits slightly forward of centre. Close the lid. Visually check that the lid fits evenly on both sides (see Fig.5). If not, adjust one of the front feet slightly until it matches. The diagram on the top and bottom are not correct.



Correct



Incorrect

To check levelling look down on the wash bowl

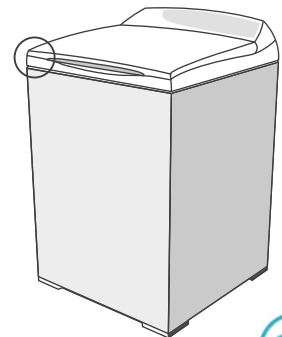
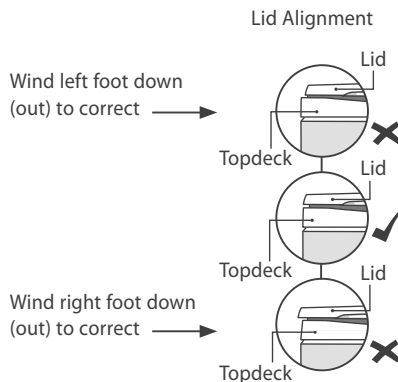

Fig.5 To assess levelling check lid alignment

- 4 Turn on the water and check all hose connections for leaks. Make sure there are no kinks in the hoses.
- 5 Uncoil power cord, remove and discard the plastic pin cover and plug into wall socket.

4 Installation instructions

Water supply

- For best operating conditions your hot water should be approximately 65°C. Your cold water should not exceed 35°C or your hot water exceed 75°C. Temperatures above these may cause the machine to fault or cause damage to the machine.
- If you have an uncontrolled water heating source (eg a wet back or solar heating system) you should fit a Safe Valve. This will ensure the hot water temperature remains within safe limits.
- Inlet water pressure: Max.1 MPa (150 psi) Min. 34 Pa (5 psi)
- Inlet water flow rate: Min. 3 litres/min
- Minimum height of taps to clear the top of the machine is 1150 mm.

Draining

- Regularly check that your standpipe or tub is free from lint or other obstructions, which may affect how your machine works or may cause flooding.
- In multi-storey apartments or any upper floor, the machine should be installed on a drained floor.
- Draining must comply with local by-laws.

Clothes washer safety

- This clothes washer is not intended for use by children and persons with reduced physical, sensory or mental capabilities, or lack of experience and knowledge, unless they have been given supervision or instruction concerning use of the appliance by a person responsible for their safety.
- Your *Smart Drive™* can be opened while it is filling and agitating. Supervise children at all times to ensure they do not play with the washer.

⚠ WARNING!



Electrical Shock Hazard

If you are using an extension cord or a portable electrical outlet device (eg multi-socket outlet box), ensure that it is positioned so that it does not come into contact with water or moisture.

Failure to do so may result in death or electrical shock.

Accessories and spare parts

Available from your Fisher & Paykel Dealer or Authorised Repairer.

Inlet Valve Cap	Part No. 388491
Hose Inlet Long (2m)	Part No. 422680
Hose Inlet Large Bore	Part No. 426123
Drain Hose Extension	Part No. 425627p
Power Cord	If the power cord of your clothes washer is damaged it must be replaced by a Fisher & Paykel Authorised Repairer, as it is not a standard power cord.

Thank you for buying a Fisher & Paykel *Smart Drive™* washing machine. We are very proud of this washer and trust it will serve you well for many years.

At Fisher & Paykel we aim to provide innovative products that are simple to use, ergonomic and energy efficient. Thousands of tonnes of washing and 75 years of laundry experience have been programmed into your washing machine to help give you the best possible performance.

We hope you enjoy your new washing machine, we have certainly enjoyed designing it.

Before you do your first wash

You owe it to yourself and your *Smart Drive™* to have it installed correctly by a technician from a Fisher & Paykel Authorised Repairer.

Before you start, it is a good idea to go through the following checklist:

- 1 Has the basepacker been removed?
- 2 Is the hot hose connected to the hot valve marked 'H'? Is the cold hose connected to the cold valve marked 'C'?
- 3 Is the drain hose threaded through the 'U bend' (with no more than 20 mm extended) and on to your standpipe?
- 4 Are the rubber inserts secured into the feet on the base of your machine and is the machine levelled? Refer to 'Installation instructions', page 3.

If you have bought a PRIDE model it is a good idea to check the warm fill temperature. (Refer to page 24).

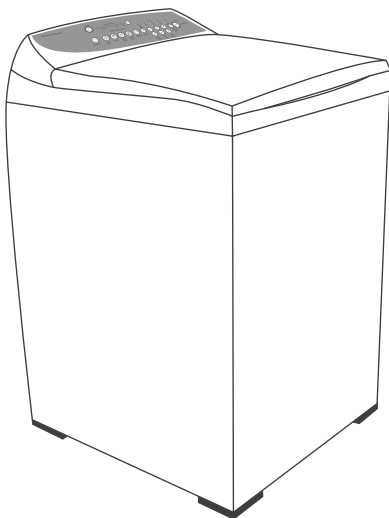

Fig.6 EXCELLENCE washer

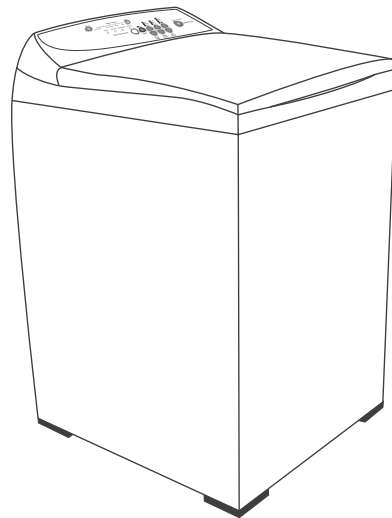

Fig.7 PRIDE washer



6 Using your EXCELLENCE washer

- Place the load evenly around the agitator (refer to 'Sorting' and 'Loading', page 19).
- Remove fabric softener dispenser.

A. Detergent

- Follow the instructions on the detergent package.
- Use the mark on the agitator, nearest to the top of the clothes, as a guide to the correct amount of detergent to use (refer to 'Detergent', page 20).
- Pour the detergent down the centre of the agitator stem.
- Replace the fabric softener dispenser (this stops small articles falling down the centre of the agitator).

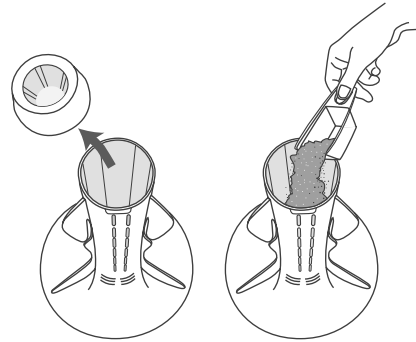

EXCELLENCE – WA75T65GW1, WA65T60GW1, WA55T56GW1

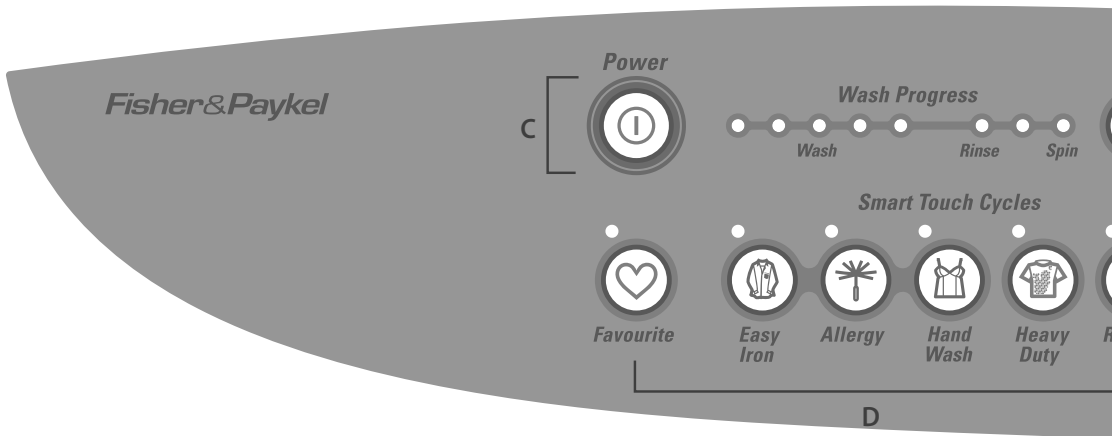

B. Fabric softener

- If you wish to use fabric softener, place it in the dispenser on the top of the agitator.

Important!

Fabric softener must not be used if you have selected the ECO or QUICK WASH option.

(Refer to 'Fabric softener', page 21).

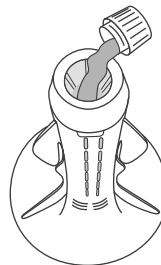

Using your EXCELLENCE washer 7

C. Power

- Press POWER to turn the machine on.

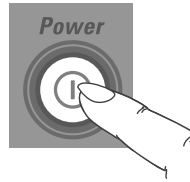

D. Wash cycles

- Select the desired wash cycle by pressing the button.

E. Wash options

- Select the WASH TEMPERATURE and other wash options (refer to pages 12 – 16).

F. Advance

- Use to advance through to the desired part of the wash cycle (refer to page 12).

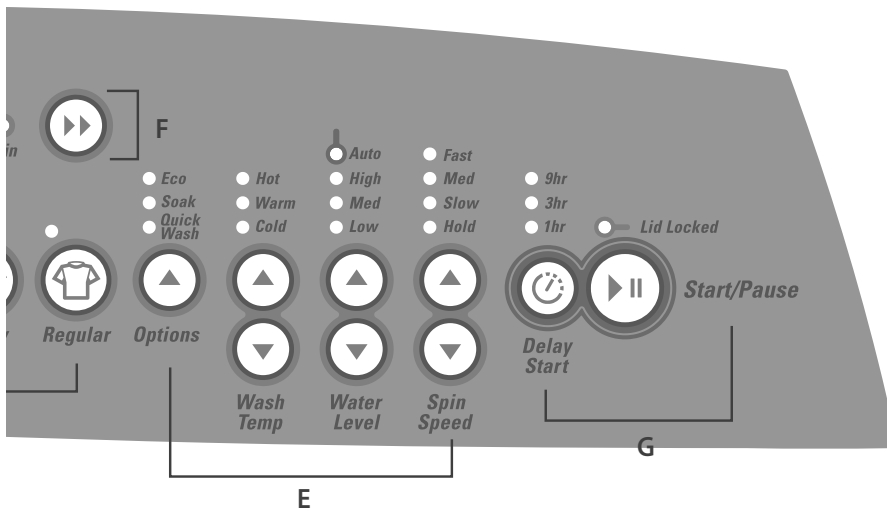

G. Start

- Press START/PAUSE to start the machine.

If you wish to stop your EXCELLENCE washer

- Press START/PAUSE.
- If it is during spray rinse or spin there is a slight delay while the bowl is coasted to a stop and the lid is unlocked.

Important!

For best fabric and colour care remove your clothes as soon as the cycle has finished.



8 Using your PRIDE washer

- Place the load evenly around the agitator (refer to 'Sorting' and 'Loading', page 19).
- Remove fabric softener dispenser.

A. Detergent

- Follow the instructions on the detergent package.
- Use the mark on the agitator, nearest to the top of the clothes, as a guide to the correct amount of detergent to use (refer to 'Detergent', page 20).
- Pour the detergent down the centre of the agitator stem.
- Replace the fabric softener dispenser (this stops small articles falling down the centre of the agitator).

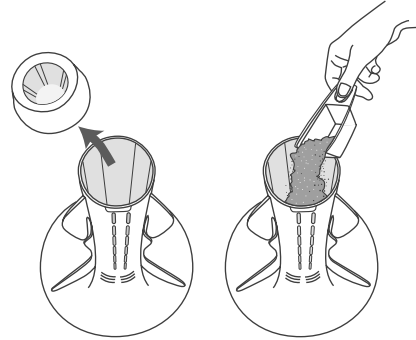

PRIDE – WA55T56MW1 (MW512)

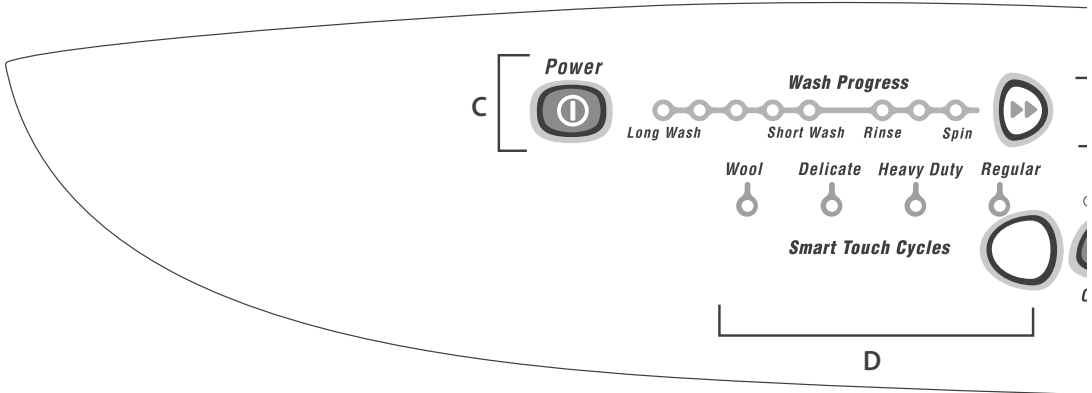

B. Fabric softener

- If you wish to use fabric softener, place it in the dispenser on the top of the agitator.

Important!

Fabric softener must not be used if you have selected the ECO option.

(Refer to 'Fabric softener', page 21).

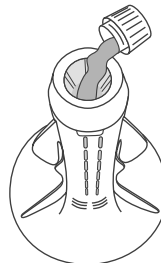

C. Power

- Press POWER to turn the machine on.

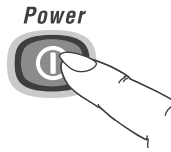

D. Wash cycles

- Select the cycle you want by pressing the SMART TOUCH CYCLES button located below the REGULAR option. Scroll through the cycles until the light for the one you want is lit.

E. Wash options

- Select the WASH TEMPERATURE and other wash options (refer to pages 12 – 16).

F. Advance

- Use to advance through to the desired part of the wash cycle (refer to page 12).

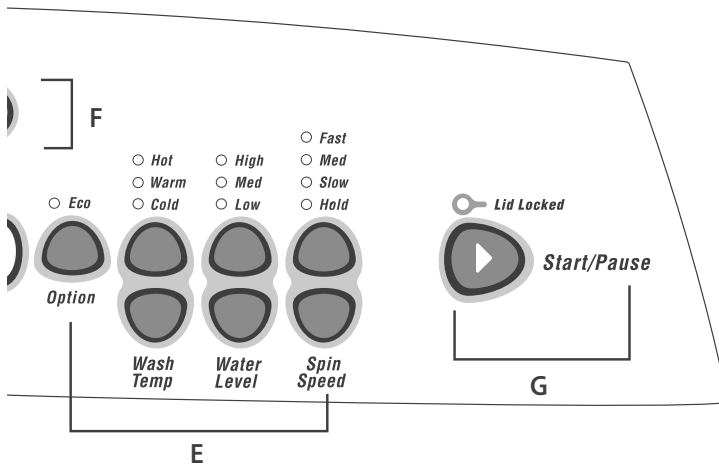

G. Start

- Press START/PAUSE to start the machine.

If you wish to stop your PRIDE washer

- Press START/PAUSE.
- If it is during spray rinse or spin there is a slight delay while the bowl coasts to a stop and the lid is unlocked.

Important!

For best fabric and colour care remove your clothes as soon as the cycle has finished.



10 Lid lock

Your *Smart Drive™* has a lid lock, which locks when your machine is spinning. This ensures the lid cannot be opened during hazardous parts of the cycle, providing added safety for you and your family.

The LID LOCK light (above the START/PAUSE button) comes on when the lid is locked to tell you when you cannot open the lid. In short it means you can open the lid while your *Smart Drive™* is filling, agitating and draining, but not while it is spinning.

- When the LID LOCK light is on, the lid is locked.
- When the LID LOCK light is off, the lid is not locked and the lid can be opened.
- If the LID LOCK light is flashing the lid lock is in process of locking or unlocking (ie while the machine coasts down or START/PAUSE has been pressed). During this stage the lid still cannot be lifted.

Important!

If the lid is left open, the machine will be unable to lock and the cycle will be halted. The machine will play a tune and the LID LOCK light will flash until the lid is closed and START/PAUSE is pressed.

The lid lock remains unlocked for the majority of the cycle allowing you to add clothes, dissolve detergent or to add fabric softener (if you do not want to use the Automatic Fabric Softener Dispenser).

The chart below shows the stages when the lid is locked.

Fill	Unlocked
Agitate	Unlocked
Spray Rinse	Locked
Deep Rinse	Unlocked
Spin	Locked

Important!

- *Keep children away from the machine, especially when you are using hot water, as the lid can be opened during fill and agitate.*
- *DO NOT put anything down the slot in the top deck of your machine.*
- *DO NOT try to disable the lid lock.*

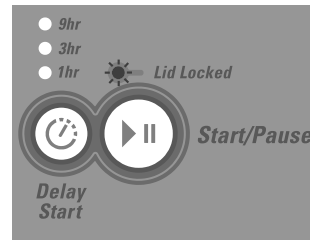

EXCELLENCE

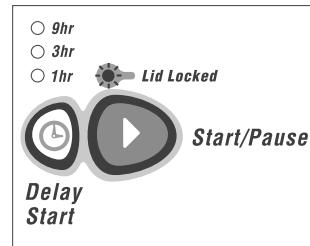

PRIDE

Fig.8 LID LOCK light

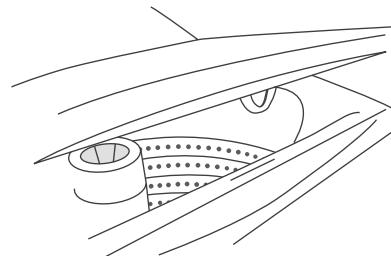

Fig.9 Lid lock



Default settings

EXCELLENCE model

	REGULAR	HEAVY DUTY	HAND WASH	ALLERGY	EASY IRON
Wash time	12 min	15 min	6 min	12 min	9 min
Wash action	REGULAR	HEAVY DUTY	HAND WASH	REGULAR	REGULAR
Wash temp	WARM-COLD	WARM	WARM-COLD	HOT	WARM-COLD
Rinse	Spray rinse + cold deep rinse	Spray rinse + cold deep rinse	2 cold deep rinses	2 cold deep rinses	2 cold deep rinses
Spin speed	FAST	FAST	SLOW	FAST	SLOW
Spin time	6 min	6 min	4 min	6 min	2 min

PRIDE model

	REGULAR	HEAVY DUTY	DELICATE	WOOL
Wash time	12 min	15 min	6 min	6 min
Wash action	REGULAR	HEAVY DUTY	DELICATE	DELICATE
Wash temp	WARM	WARM	WARM	WARM
Rinse	Spray rinse + cold deep rinse	Spray rinse + cold deep rinse	2 cold deep rinses	Spray rinse + cold deep rinse
Spin speed	FAST	FAST	SLOW	MEDIUM
Spin time	6 min	6 min	4 min	6 min

Model variations

EXCELLENCE model – Fully featured, with REGULAR, HEAVY DUTY, HAND WASH, ALLERGY and EASY IRON cycles, and a FAVOURITE cycle.

PRIDE model – REGULAR, HEAVY DUTY, DELICATE and WOOL cycles.

Basic cycle descriptions

- REGULAR cycle (with the ECO option) has been designed for normally soiled, everyday washing, eg sheets, towels, T-shirts.
- HEAVY DUTY cycle is for heavily soiled durable garments, eg overalls, jeans, tea towels.
- HAND WASH cycle is designed for your most delicate garments.
- ALLERGY cycle has been designed for those with skin and other sensitivities.
- EASY IRON cycle is for items susceptible to creasing, eg shirts, dress trousers.
- DELICATE cycle uses a slow, gentle agitation designed to care for your delicate items, eg lingerie, blouses.
- WOOL cycle is for machine washable woollens.



12 Wash options and advancing the cycle

To select the wash options

EXCELLENCE model

- 1 Select the wash cycle, temperature, water level and spin speed (refer to page 7).
- 2 Press the OPTIONS button if you want to choose ECO, SOAK or QUICK WASH (refer to pages 14 and 15).
- 3 Press START/PAUSE.

PRIDE model

- 1 Select the wash cycle, temperature, water level and spin speed (refer to page 9).
- 2 If you wish to save water press the ECO option button (refer to page 14).
- 3 Press START/PAUSE.

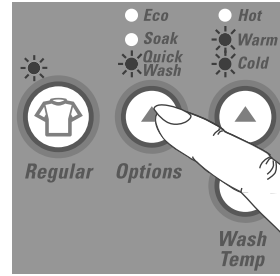

EXCELLENCE

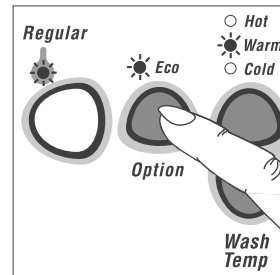

PRIDE

Fig.10 Selecting wash options

The wash progress lights

The wash progress lights show all the tasks your *Smart Drive™* will do during the wash cycle. As each task is completed a light goes out, so you can tell at a glance how far the cycle has to go.

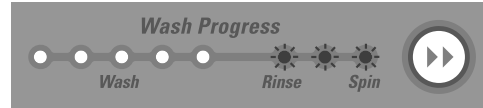

Fig.11 Wash progress lights

Note: while EXCELLENCE model is shown, PRIDE model is identical

To advance the wash cycle

- 1 Press POWER.
- 2 Press the button with the 'two arrows' repeatedly to advance the cycle, to the desired position.
- 3 Press START/PAUSE.

Note: each wash progress light equals 3 minutes of agitation. The ECO option wash progress lights may in some cases wash for longer. This is dependent on the water level. The QUICK WASH option shortens the agitation time for each progress light (EXCELLENCE model only).



EXCELLENCE

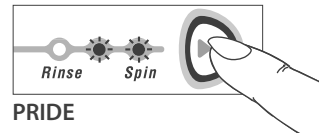

PRIDE

Fig.12 Advancing the wash cycle

Clothes care safeguards

To avoid accidentally damaging your clothes there are a few options that your *Smart Drive™* will not accept. For example, you cannot select a HOT wash on HAND WASH or EASY IRON cycles (EXCELLENCE model) or DELICATE or WOOL cycles (PRIDE model), or choose the ECO option on anything other than the HEAVY DUTY or REGULAR cycles (both models).



Manual water level selection

The agitator has five levels marked on its stem that can be used to help you select the correct water level. Select the correct water level by using the mark nearest to the top of the load.

- The levels marked on the agitator do not correspond exactly to the level of the water. They indicate the level of dry clothes suitable for the water level.
- Your *Smart Drive™* may occasionally add water during agitation. This is to maintain the water level due to the release of air trapped in the garments.
- The medium/high and medium/low settings are available on EXCELLENCE model only.
- Out of balance loads, tangling or splash-over can be caused by selecting a water level that is too high.

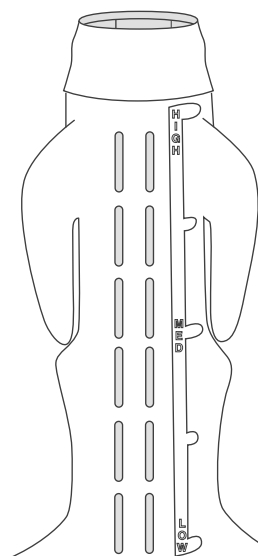

Fig.13 Water level guide on agitator

Auto water level

EXCELLENCE model only

Your *Smart Drive™* can automatically select the appropriate water level for the load.

- 1 Place your clothes in the machine.
- 2 Select the wash cycle (select AUTO if not automatically selected).
- 3 Press START/PAUSE.

During fill, the machine will pause occasionally to sense the water level. The machine will check if the water level is correct by using a series of two different agitate strokes. A slow stroke to sense the load and an agitate stroke to mix the load. (This may take over a minute.) If it detects that the water level is not high enough, it will fill with more water and check the level.

- When washing an unusual load, eg large bulky garments or pillows, we recommend you manually select the water level and select the HAND WASH cycle (EXCELLENCE model) or the DELICATE cycle (PRIDE model).
- Manually select the water level if there is already water in the bowl.



Fig.14 Selecting AUTO water level

Note: if you feel the AUTO water level does not fill to the correct level, you can adjust the level the machine selects (refer to 'Changing pre-set options', pages 22 and 25).



14 Wash options – saving water and time

Eco

EXCELLENCE and PRIDE model

Press the ECO option in order to save water. The ECO option uses an Eco Spray rinse which has been specially designed to use at least 25% less water than a traditional rinse. Use this option when you want to use less detergent and less water. However, If you have low water pressure or sensitive skin it is better to use a traditional rinse.

The ECO option has not been designed to be used with fabric softener as it does not have a second deep rinse to dispense the softener correctly. Fabric softener should not be used if this option is selected.

Note: the ECO option is only available on the REGULAR and HEAVY DUTY cycles. If you try to select these options on the HAND WASH, ALLERGY or EASY IRON cycles (EXCELLENCE model), or the WOOL or DELICATE cycles (PRIDE model), your *Smart Drive™* will skip over the option. ECO will take slightly longer than a normal spray and deep rinse.

There are some wash loads that may not suit being washed using the ECO option. For instance, loads that have a lot of sand or sawdust in them or garments where the colour still runs from them.

Quick wash

EXCELLENCE model only

Our EXCELLENCE model provides an excellent opportunity to save on water and time. Use the QUICK WASH option when you want to save time and reduce the amount of water used during the REGULAR, HEAVY DUTY, HAND WASH or EASY IRON wash cycles.

The QUICK WASH option has not been designed to be used with fabric softener as it does not have a second deep rinse to dispense the softener correctly. Fabric softener should not be used if this option is selected.

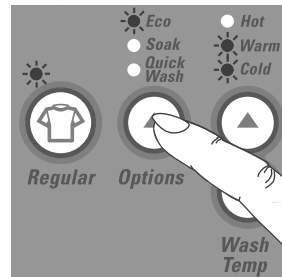

EXCELLENCE

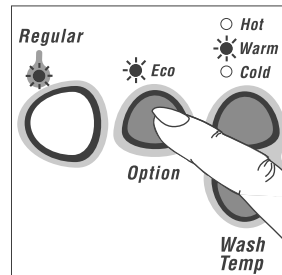

PRIDE

Fig.15 Selecting the ECO option

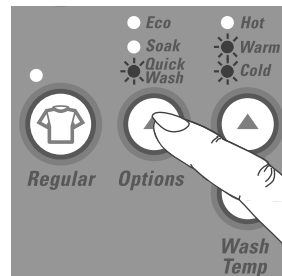

EXCELLENCE

Fig.16 Selecting the QUICK WASH option



Soak

EXCELLENCE model only

Use the SOAK option to soak clothes at the end of the wash phase or when you wish to re-use the wash water.

When you select SOAK your *Smart Drive™* will soak for a period of 2 hours before completing RINSE and SPIN. During SOAK your *Smart Drive™* will agitate for a few seconds every minute.

Nappy sanitisers/bleach

Nappy sanitisers and bleach are very corrosive to metal surfaces. These should not be used in your machine.

Important!

DO NOT use your *Smart Drive™* to soak items in bleach or sanitiser, or tip the contents of the nappy bucket into your machine. The chemicals in these products can damage your washer. Rinse and wring items out thoroughly before placing them in your machine.

Spin Hold

EXCELLENCE & PRIDE model

Use the SPIN HOLD option to:

- Remove drip dry garments from a mixed load before the wash goes into SPIN.
- Minimise the clothes creasing when they are left to sit in the bottom of the bowl at the end of the cycle.

When you have selected SPIN HOLD, your *Smart Drive™* will pause at the end of RINSE, beep and the SPIN light will flash to tell you that it is waiting for another instruction.

Press START/PAUSE to begin the spin.

Delay Start

EXCELLENCE model only

DELAY START will delay the start of the wash cycle for 1, 3 or 9 hours.

Press DELAY START once for a delay of 1 hour. Press again for 3 hours, a third time for 9 hours (and again to return to normal).

- Once you press DELAY START your *Smart Drive™* will begin the delay period, you do not have to press START/PAUSE.
- Be careful if using DELAY START for non-colourfast clothes as dyes may run if the clothes are damp.
- Your *Smart Drive™* will not beep at the end of the cycle if DELAY START is selected.

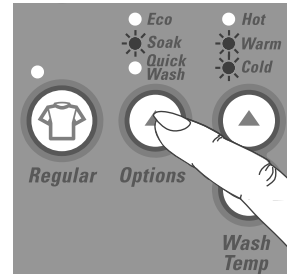

EXCELLENCE

Fig.17 Selecting the SOAK option



EXCELLENCE

Fig.18 Selecting the SPIN HOLD option

Note: while EXCELLENCE model is shown, setting of the PRIDE model is identical

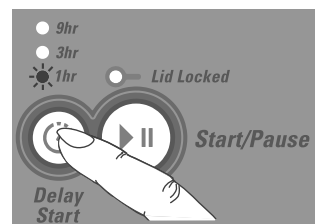

Fig.19 Selecting DELAY START

16 Wash options

Washing bulky items

Forcing large items into the machine may result in them being damaged during washing. Make sure there is enough room in the machine for items to move when being washed.

Some items float up during the wash (eg duvets/ doonas and pillows). If they sit too high they may touch stationary parts of the machine during agitate or spin. To minimise the chance of this happening, bulky items should be pushed down below the water level after fill and pushed to sit below the medium high water level mark on the agitator before spinning. Select a SLOW spin.

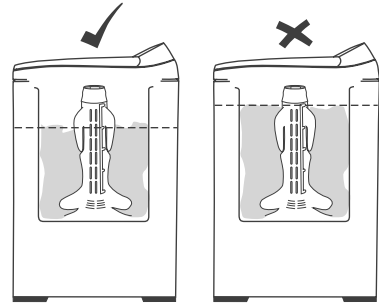

Fig.20 Bulky items should sit below the medium high water level mark.

Important!

To prevent an out of balance load or splash-over we recommend washing these items on the **HAND WASH cycle (EXCELLENCE model) or the DELICATE cycle (PRIDE model).**

If you wish to re-spin the load at a faster speed make sure the load is sitting below the medium-high mark before spinning.

Washing woollens

Many woollen items carry a MACHINE WASHABLE care claim. The fibres of these woollens have been treated to prevent felting when they are machine washed.

- Check the care label.
- Use a wool detergent.
- Use the specially designed **HAND WASH cycle (EXCELLENCE model) or WOOL cycle (PRIDE model)**. For your more durable woollens you may want to use the **EASY IRON cycle (EXCELLENCE model only)**.
- Hand washed woollens may be spun in your *Smart Drive™*.
- To dry woollens lie them flat on a towel and pat into shape. Dry out of direct sunlight.

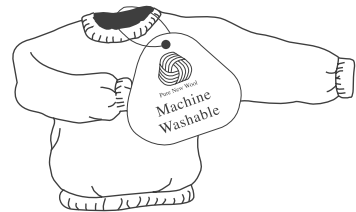

Most handcrafted garments are not made of machine washable wool and we recommend that you wash them by hand only.

Note: some wool underlays and sheepskin products can be washed in a washing machine but could produce excessive amounts of lint that may cause pump blockages.



FAVOURITE cycle

EXCELLENCE model only

The FAVOURITE cycle lets *you* design the wash cycle. It can be any wash cycle with any of its wash options and it can start from any point in the cycle. For instance, it may be a cycle to wash your gym gear or it may be a rinse and spin to finish washing the nappies.

To set your favourite cycle

- 1 Press POWER.
- 2 Press the FAVOURITE cycle button. Hold down for 2 seconds.
- 3 You will hear 2 quick beeps and the FAVOURITE light will flash.
- 4 Select your most preferred ('favourite') cycle, (eg REGULAR, ALLERGY).
- 5 Select the wash options (eg COLD wash, SOAK). Use ADVANCE if you want part of a cycle (eg to rinse nappies).
- 6 Press FAVOURITE again to store your favourite cycle.

To change your FAVOURITE cycle simply repeat these steps.

Note: your *Smart Drive*™ will remember your FAVOURITE cycle even when it is turned off at the wall. It is not possible to program a delayed start into the FAVOURITE cycle.

To use your favourite cycle

- 1 Press POWER.
- 2 Press FAVOURITE.
(Your favourite cycle and wash options will be automatically selected).
- 3 Press START/PAUSE.

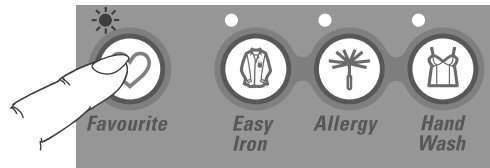

Fig.21 The FAVOURITE cycle



18 Customising the wash cycles

To customise a cycle

EXCELLENCE model only

You can program your *Smart Drive*™ to remember the wash options you prefer for each wash cycle. For instance, you may want to set the REGULAR cycle to a COLD wash or set HEAVY DUTY to include a SOAK.

- 1 Press POWER.
- 2 Press the wash cycle button. Hold down for 2 seconds.
You will hear 2 quick beeps and the wash cycle light will flash.
- 3 Select your wash options (eg COLD wash, SOAK).
- 4 Press the wash cycle again to store your customised cycle.

To change your customised wash cycle simply repeat these steps.

When you are customising a wash cycle you can shorten or lengthen the agitation time.

- To shorten the agitation time, press the ADVANCE button to reduce the number of wash progress lights.
- To increase the agitation time keep pressing the ADVANCE button until all the wash progress lights are on (see page 12).

Note: unlike the FAVOURITE cycle you cannot customise a wash cycle to start at the RINSE or SPIN stage. On HEAVY DUTY and HAND WASH you can only decrease the wash time.

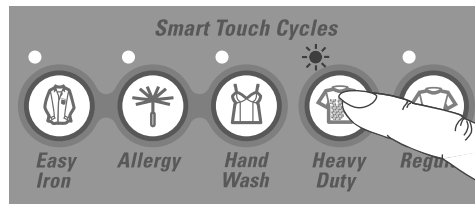

Fig.22 Customising a wash cycle



Sorting

To get the best wash results it pays to sort your clothes before washing.

Care labels

The care label will tell you about the fabric of the garment and how it should be washed.

Soil

Sort clothes according to the type and amount of soil. Some soils suit warmer washes, eg oily soils, while others are best washed in cold water, eg mud, blood.

Colour

Sort white fabrics from coloured fabrics.

Lint

Wash lint givers and lint collectors separately. Where possible, turn lint collectors inside out.

Loading

Check pockets

Loose items can damage both your *Smart Drive™* and your clothes.

Close zippers, hooks and eyes

This is to make sure that these items do not snag on other clothes.

Mend any torn garments or loose buttons

Tears or holes may become larger during washing. Remove any loose bra wires as they can damage your washing machine and/or dryer.

Pretreat any stains

Make sure you use an appropriate surface to apply treatments. Do not use the lid or top of the machine as damage may occur to these surfaces.

Make sure the water level suits the load size

Select the correct water level by using the mark on the agitator nearest to the top of the load. Ensure that the load does not extend above the fabric softener dispenser as splashing may occur.

For a balanced load

- Place unfolded clothes firmly and evenly around the agitator.
- Do not wrap large items, such as sheets, around the agitator.
- A mixture of small and large items will wash the best.

	Machine Washable Warm 40°C max Warm Rinse Well Normal Spin
	Do not bleach
	Do not tumble dry Dry in shade
	Warm iron
	Dry Cleanable

Examples of different care label symbols.

Lint givers	Lint collectors
Towels	Synthetics
Chenille	Corduroy
Nappies	Poly cotton
	Socks



Choosing the right detergent

We recommend using domestic detergent, (powder or liquid).

Soap flakes or granulated soap powders should not be used in your *Smart Drive™*, eg Lux Soap Flakes.

When washing woollens remember to use a recommended detergent.

How much detergent?

Use the instructions on the back of the detergent packet as a guide to the correct amount of detergent to use. The correct amount of detergent will vary depending on the amount of soil in your clothes and the size of your load. Jeans and work clothes may need more detergent, while towels usually need less. The larger your machine, the more detergent you may have to add.

Adding the detergent

Liquid or powdered detergents

- 1 Remove fabric softener dispenser.
- 2 Pour liquid or powdered detergent down the centre of the agitator.
Some detergents **MUST** be fully dissolved before adding to your machine to get the best wash results. Check the instructions on the detergent packet.
Pre-dissolving the detergent when washing in cold water can improve its performance.
- 3 Replace fabric softener dispenser (this prevents small articles falling down the centre of the agitator).

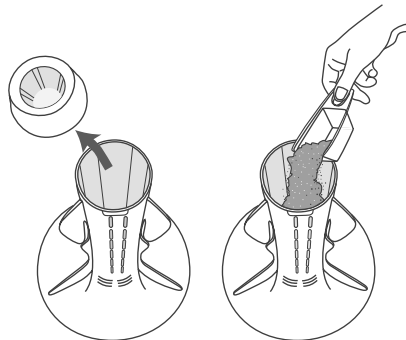

Fig.23 Adding your detergent

Concentrate			
Model	5.5 kg	6.5 kg	7.5 kg
Water level	Number of scoops		
high	1 rounded	1½	1½
med high	1 scant	1 heaped	1½
medium	¾	1 scant	1
med low	½	⅔	¾
low	⅓	⅓	½

Liquid			
Model	5.5 kg	6.5 kg	7.5 kg
Water level	Number of caps		
high	1 cap	1¼ cap	1½ cap
med high	1 cap	1 cap	1¼ cap
medium	¾ cap	¾ cap	1 cap
med low	½ cap	½ cap	¾ cap
low	⅓ cap	⅓ cap	½ cap



How the fabric softener is dispensed

The fabric softener goes into the dispenser on the top of the agitator. During the rinse the machine spins to release the fabric softener, delivering it down the agitator stem as the machine fills for the final deep rinse.

Note: ECO and QUICK WASH options are not designed to be used with fabric softener. Cycles using these options do not use a deep rinse so the machine cannot dispense fabric softener correctly.

How much fabric softener?

The ring on the dispenser cup is a guide for the amount of fabric softener to add for a full load. Smaller loads require less fabric softener.

Cleaning the dispenser

When using fabric softener, rinse your dispenser at the end of each wash.

- 1 Separate the cup from the dispenser body by pushing downward on the base of the cup.
- 2 Rinse both parts of the dispenser using warm soapy water.

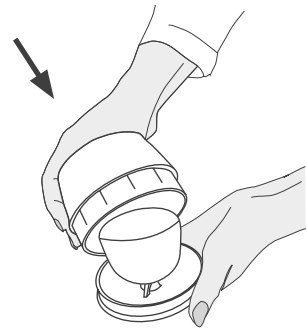

Fig.24 Push cup through dispenser with thumb to remove

Scrud

Scrud is the name given to the waxy build-up that can occur within any washer when the fabric softener comes into contact with detergent. This build-up is not brought about by a fault in the machine. If scrud is allowed to build up in the machine it can result in stains on your clothes or an unpleasant smell in your washer.

If you wish to use fabric softener we recommend:

- Using fabric softener sparingly.
- When filling the dispenser, do not splash or overfill.
- Clean dispenser as soon as the cycle has finished.
- Clean your machine regularly (refer page 27).
- Cold water washing increases the chance of this build-up occurring. We recommend a WARM or HOT wash at regular intervals, eg approximately every 5th wash.
- Fabric softener of a thinner consistency is less likely to leave residue on the dispenser and contribute to a build-up.



22 Changing pre-set options

Option adjustment mode

After using your *Smart Drive*™ you may want to fine tune some of the options to suit your wash needs.

There are a number of pre-set options, which can be altered.

In the EXCELLENCE model the following pre-set options can be changed:

- The wash temperatures.
- The RINSE option on HEAVY DUTY and REGULAR cycles.
- The COLD wash to CONTROLLED COLD.
- The number of beeps at the end of the cycle.
- The fill level selected by AUTO water level.
- The out of balance recovery routine.

In the PRIDE model the following pre-set options can be changed:

- The WARM wash temperature.
- The RINSE option on HEAVY DUTY, REGULAR and WOOL cycles.
- The out of balance recovery routine.

To enter option adjustment mode

- 1 Turn machine on at the wall but do not press POWER. Press START/PAUSE and hold down, then press POWER. You will hear two quick beeps and the machine will show an unusual pattern of lights.

In this mode the lights are used to indicate the different options available.

The diagram on page 23 shows how the lights relate to the options you can change.

Pages 24 – 26 explain the different options in more detail.

- 2 Use the buttons on the panel to make your changes to the pre-set options.
- 3 Press POWER to return to normal mode.
- 4 Your *Smart Drive*™ will automatically remember your changes.

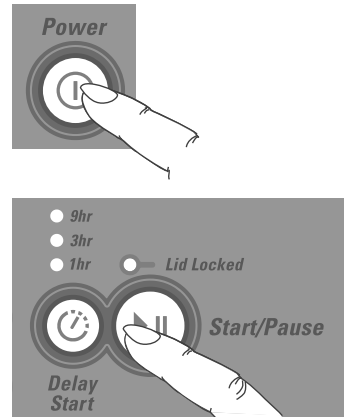

EXCELLENCE

Fig.25 Entering Option Adjustment mode

Note: while EXCELLENCE model is shown, setting of the PRIDE model is identical



- 1 Press START/PAUSE and hold down. Press POWER.
- 2 The diagram below shows how the lights relate to the options you can change. It also shows what lights will be on when you first enter the option adjustment mode.

Use this diagram to help you adjust the options on the EXCELLENCE model.

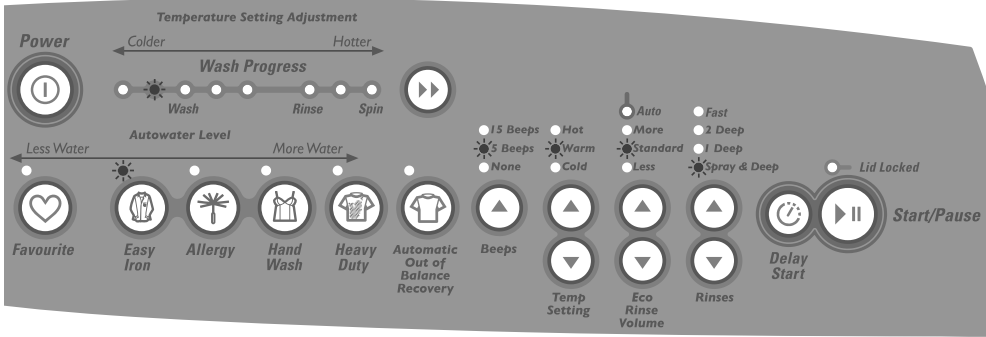

Fig.26 Option adjustment on the EXCELLENCE model

Use this diagram to help you adjust the options on the PRIDE model.

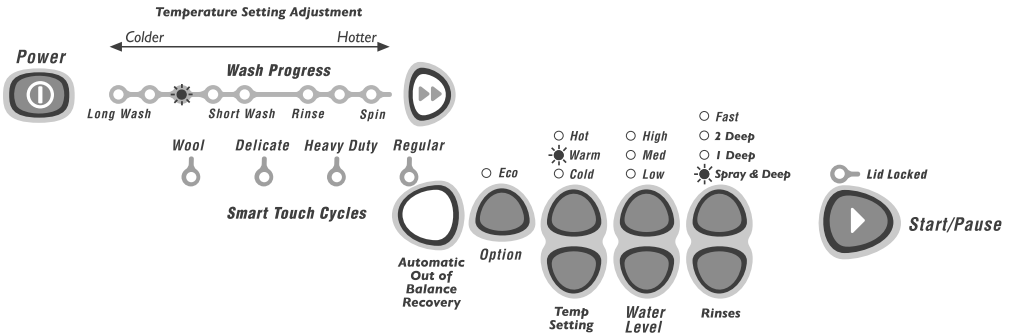

Fig.27 Option adjustment on the PRIDE model

- 3 Use the buttons on the panel to change the pre-set options.



EXCELLENCE

Fig.28 Option adjustment selection
Note: while EXCELLENCE model is shown, setting of the PRIDE model is identical



24 Changing pre-set options

Wash temperatures

On the PRIDE model the WARM temperature can be adjusted if you think it is too hot or too cold. Note: on these models the hot temperature will be the same as the hot water supply temperature.

On EXCELLENCE model all wash temperatures can be individually adjusted.

- 1 Select the WASH TEMPERATURE you want to adjust.
- 2 The wash progress lights show the temperature adjustment possible for that temperature.
 - Pressing the ADVANCE will cause the wash progress light that is on to change.
 - Advancing the wash progress light will increase the wash temperature. If you keep pressing the ADVANCE, the light will scroll back to the coldest setting available for that wash temperature.

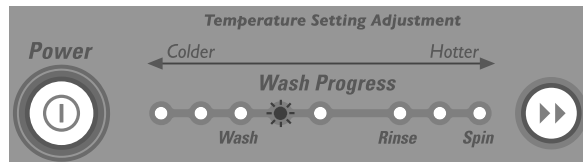

Fig.29 Adjusting the temperature setting

Note: while EXCELLENCE model is shown, the setting of the PRIDE model is identical

Note: if you have a PRIDE model and still can't get the temperature you require, advance the progress light (while in the options adjustment mode) across to SPIN and manually adjust the flow of the taps.

Rinse options

On the HEAVY DUTY and REGULAR cycles (EXCELLENCE model) and on the HEAVY DUTY, REGULAR and WOOL cycles (PRIDE model) you can change the pre-set rinse option.

The default rinse option on these cycles is a spray rinse followed by a deep rinse. The first step of the default rinse can be replaced with a short spin, or a deep rinse, by selecting another option.

If you have a problem with impurities in your water supply you may get a better result if you change the rinse option to 2 DEEP rinses. If you wish to conserve water, change the rinse option to 1 DEEP rinse. If you want to conserve even more water, choose the ECO option.

Rinse options		
	Rinse 1	Rinse 2
MED spin light on	Deep rinse	Deep rinse
SLOW spin light on	Short spin	Deep rinse
HOLD light on (default)	Spray rinse	Deep rinse



Controlled cold

EXCELLENCE model only

If your cold water temperature is very low you will not get a very effective wash. The CONTROLLED COLD option solves this problem by adding a small amount of hot water to raise the temperature of the wash. We have called this "CONTROLLED COLD".

- 1 Select COLD wash temperature.
- 2 The wash progress lights show the temperature adjustment possible.
 - When the first progress light is on, the machine will fill with cold water only.
 - Press the ADVANCE button to select the second light and your *Smart Drive™* will control the temperature to approximately 20°C. Each following light equals approximately a 1°C temperature rise.

Note: if you always use COLD or CONTROLLED COLD water, we recommend that a WARM or HOT wash be used regularly, eg every 5th wash should be at least a warm one.

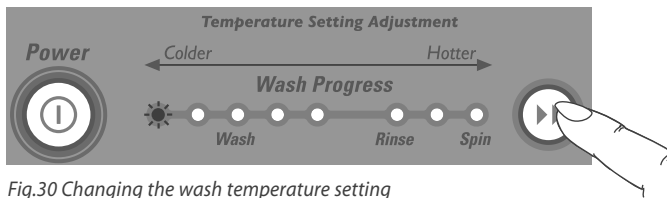

Fig.30 Changing the wash temperature setting

End of cycle beeps

EXCELLENCE model only

The beeps signalling the end of the cycle can be increased or decreased. Press the options button up to increase beeps or down for no beeps.

Auto water fill level

EXCELLENCE model only

If you are not satisfied with the level that your *Smart Drive™* fills to on AUTO water level, you can increase or decrease the fill level that AUTO will select.

Note: if you feel there is not enough water for the load, we recommend you check by pausing the machine and pushing the clothes down to see how much spare water is at the bottom of the bowl. Clothes often float and your *Smart Drive™* can sense the water under the clothes.

Light on	Option
FAVOURITE	less water
EASY IRON	factory setting
ALLERGY	more water +
HAND WASH	more water ++
HEAVY DUTY	more water +++



26 Changing pre-set options

Out of balance recovery routine

When your *Smart Drive™* is spinning it can sense if the wash load is out of balance and will stop and re-try spinning up to three times. If it still senses an unbalanced load there are two options the machine can take.

Automatic recovery option

Your *Smart Drive™* will try to automatically correct the out of balance load. It will fill with water and agitate to redistribute the load before trying to spin up again.

Machine stops option

Your *Smart Drive™* will stop, give a short burst of beeps every five seconds, and the RINSE or SPIN light will flash. You must redistribute the load more evenly yourself (use this option if you wish to conserve water).

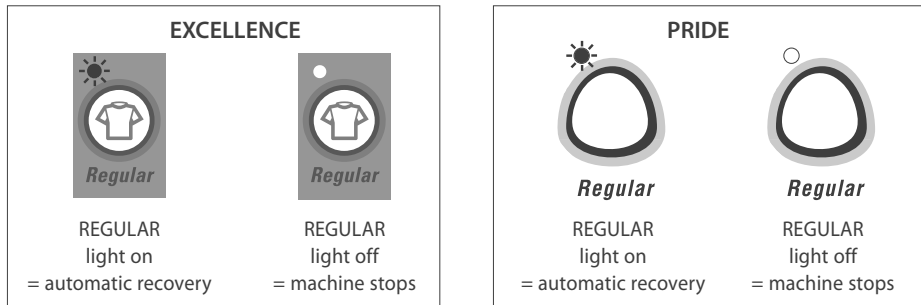

Fig.31 Adjusting the Out of balance recovery routine

Machine information

Specifications

Model	Capacity	Depth	Width	Height*	Height (lid open)
WA75T65GW1	7.5 kg	650 mm	650 mm	1020 – 1050 mm	1410 – 1440 mm
WA65T60GW1	6.5 kg	600 mm	600 mm	1020 – 1050 mm	1360 – 1390 mm
WA55T56GW1	5.5 kg	560 mm	560 mm	1020 – 1050 mm	1320 – 1350 mm
WA55T56MW1 (MW512)	5.5 kg	560 mm	560 mm	1020 – 1050 mm	1320 – 1350 mm

- Electrical Supply: 220 – 240 V, 50 Hz Sinusoidal, 165 W
- Inlet Water Pressure: Max. 1 MPa (150 psi) Min. 34 Pa (5 psi)
- Inlet Water Flow Rate: Min. 3 litres/min
- Standpipe Height: 850 – 1200 mm

Note: exact height of your *Smart Drive™* is dependent on how far the feet are inserted onto the base of the machine.

* Height is measured to the highest point on the console.



When you have finished

- Turn off the taps to prevent the chance of flooding should a hose burst.
- Turn off the power at the wall.

Cold water washing

If you always use cold water, we recommend that a WARM or HOT wash be used at regular intervals, eg every 5th wash should be at least a warm one.

Cleaning your Smart Drive™

- Clean with a soft damp cloth and wipe dry. Do not use scouring cleaners as they can damage the paint, plastic and panel surfaces.
- Clean the fabric softener dispenser after each cycle using warm soapy water.
- You can remove the lid for cleaning. Open the lid fully, hold one side with one hand and gently tap the other side with an upward motion.
To replace the lid, hold the lid vertically and align both hinges before pushing down firmly.
- To remove the agitator for cleaning, unscrew the nut down the centre of the agitator by turning anti-clockwise.

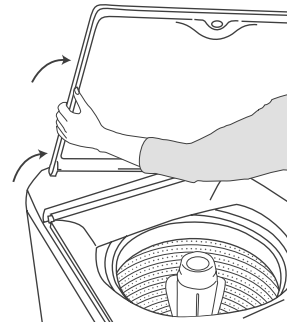
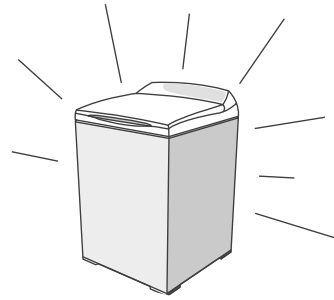

Fig.32 Removing the lid

Important!

The agitator must be fully pushed onto the shaft when refitting. Tighten the nut firmly by hand. Ensure the agitator is not loose.

Cleaning the inside of your Smart Drive™

If you use fabric softener or do regular cold water washing, it is important that you occasionally clean the inside of your machine.

- Fill your machine with hot water. Add about two cups of a powdered detergent.
- Let it agitate for 10 – 15 minutes.
- Stop the machine (press START/PAUSE), **open the lid** and leave it to soak overnight.
- After soaking, drain the machine (advance to SPIN) and then run the machine through a REGULAR cycle.

We do not recommend that you wash clothes during this procedure.



Products that might damage your *Smart Drive*[™]

- Concentrated bleaches, nappy sanitisers and hydrocarbon solvents (eg petrol and paint thinners) can cause damage to the paintwork and components of your washer. (Be careful when washing garments stained with solvents as they are flammable. DO NOT put them in your dryer).
- Do not use pre-treatment sprays or liquids on or near your washer as they can damage your machine's control panel and plastic surfaces.
- Use of dyes in your washer may cause staining of the plastic components. The dye will not damage the machine but we suggest you thoroughly clean your washer afterwards. We do not recommend the use of dye strippers in your washer.

Smart Drive[™] sounds and beeps

Your *Smart Drive*[™] will make sounds that you will not have heard from other clothes washers.

- During drain you will hear the pump in your machine turn off and on quickly about every 10 seconds. This is part of your *Smart Drive*[™] automatic lint removal system.
- While draining your machine may give several low thuds. Your machine is checking that the water has drained before spinning.
- Your *Smart Drive*[™] will beep at the end of the cycle and if you have used SPIN HOLD or SOAK.
- If your machine is beeping continuously or giving a musical series of beeps refer to page 31.

Automatic lint system

Your *Smart Drive*[™] has a self-cleaning lint system. It automatically separates the lint from the wash water, trapping the lint between the inner and outer bowls and flushes it out at the end of the wash.



- Full loads are more efficient than part loads.
- Use the ECO option (refer to page 14).
- Adjust the RINSE option on REGULAR and HEAVY DUTY cycles (EXCELLENCE model), and REGULAR, HEAVY DUTY and WOOL cycles (PRIDE model) to one deep rinse (refer to page 24).
- Adjust AUTO water level to fill with less water (EXCELLENCE model only, page 25).



Recycling the wash water

EXCELLENCE model only

Your *Smart Drive*™ also offers several ways of reusing the wash and rinse water.

- 1 Select SOAK on the first wash cycle.
- 2 Remove the clothes at the end of the wash phase and add the second load to the wash water.
- 3 Select the wash cycle for the second load. You may need to add extra detergent.
- 4 Remove the second load at the end of the cycle.
- 5 Replace the first load, select RINSE and complete the cycle.

Recycling the water from a deep rinse

- 1 Select SPIN HOLD on the first wash cycle (Note: you cannot use the ECO option when recycling the water from a deep rinse).
- 2 Remove the clothes at the end of the rinse and add the second load to the rinse water.
- 3 Select the wash cycle for the second load.
- 4 Remove the second load at the end of the cycle.
- 5 Replace the first load and spin dry.



Manual suds save with syphon back

If you have a large tub near your washing machine and a separate drain outlet you can set up another method of reusing the water.

(The tub should hold a minimum of 100 litres or have an overflow).

- 1 Select SOAK on the first wash cycle.
- 2 At the end of the wash phase place the drain hose in the tub.
- 3 Cancel SOAK (press ADVANCE button). The suds water will be pumped into the tub. Do not leave your machine until pump out is completed.
- 4 Once your tub is filled return the drain hose to the drain. This must be done before the machine starts spinning.
- 5 Allow the machine to complete the rest of the cycle. Remove the first wash load and place the second load in the machine.
- 6 To syphon back the suds place the end of the drain hose in the tub, ensure that the end is near the bottom of the tub.
- 7 Advance to SPIN and allow the machine to pump for a few seconds to clear air from the drain hose, then press POWER to turn the machine off.
- 8 The suds water will syphon back into the machine. It will take several minutes to syphon back the water.
- 9 RETURN HOSE TO DRAIN.
- 10 Select second wash cycle.

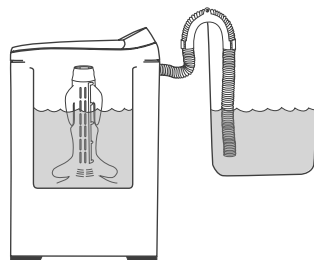

Note: You will only be able to syphon back into the machine until the water level is equal to that in the tub.

Fig.33 Reusing water using syphon back method

The above method can also be used to recycle the water from a deep rinse. Select SPIN HOLD in place of SOAK.

Note: for any of the above methods, manually select the water level for the second wash load. AUTO water level may fill to a level too high for the clothes load if there is already water in the wash bowl.



Your *Smart Drive*™ is capable of diagnosing its own problems. If your *Smart Drive*™ gives a musical series of beeps every 5 seconds it is telling you that it has a problem which you can solve using the checklist below.

* The beeps are the same sound your washer makes when you turn it on at the wall.

Musical series of beeps* every 5 seconds and... possible solutions

HOT water temperature light is flashing.

Hot water supply is not hot enough to maintain the wash temperature you have selected. Select a lower wash temperature.

Inlet hose filters may be blocked.

There may be a kink in the hose.

Hot tap has not been turned on.

Inlet hoses are connected to the wrong taps.

COLD water temperature light is flashing.

Cold tap has not been turned on.

Inlet hose filters may be blocked.

There may be a kink in the hose.

Inlet hoses are connected to the wrong taps.

Cold water temperature exceeds recommended limits (see 'Installation instructions', page 4).

The flow rate of the supply water is too slow.

HOT and COLD water temperature lights are flashing.

The taps have not been turned on.

Inlet hose filters may be blocked.

The hoses may be kinked.

The drain hose is too low or the drain hose is pushed into the standpipe too far and the water is siphoning out of the machine (see 'Installations instructions', page 2).

The flow rate of the supply water is too slow.

HIGH water level light is flashing.

The machine is overloaded and can not agitate. Ensure the machine is stationary. Remove items until the remaining ones can move freely.

Select a higher water level.

The first RINSE progress light or SPIN progress light is flashing.

The machine has a suds build-up (too much detergent may have been used for the amount of soil in the load). Wait for suds to dissolve (about 20 min). Rinse clothes using a deep rinse.



32 If your *Smart Drive*™ beeps for help

LID LOCK light is flashing.

Make sure the lid is closed.

Press START/PAUSE (refer to page 10).

If the symptom persists call your Fisher & Paykel Dealer or Authorised Repairer.

First RINSE or SPIN progress light is flashing as well as the SPIN SPEED light.

Wash load is out of balance. Ensure the machine is stationary. Manually redistribute the load. Check the machine is level (refer to page 3).

Single beep every second and... possible solutions

Some lights are on but the pattern of lights is unfamiliar.

- 1 Turn your machine off at the wall,
- 2 Wait for 60 seconds and turn it back on.
- 3 Check the machine is level (refer to page 3).
- 4 Remove load and retry.
- 5 Put through a deep RINSE and SPIN.
- 6 If the fault re-occurs repeat Step 1.

If the machine still will not work call your Fisher & Paykel Dealer or Authorised Repairer to arrange service (refer to page 37).



Pressing POWER does not turn the machine on.

Is the power switched on at the wall?

Switch the power off at the wall and wait 60 seconds before turning the power on again.

Could your household power supply be at fault? Try plugging in another electrical appliance.

Pressing START/PAUSE does not start the fill.

Are both hot and cold taps turned on?

Are the inlet hose filters blocked?

Is DELAY START on?

Filling continuously.

Check that the machine is not syphoning (refer to page 2 in the 'Installation instructions').

Not spinning properly.

Is the load out of balance? Refer to pages 13, 16 and 26.

Check the machine is level and does not rock (refer page 3).

It may have suds build-up (refer to 'RINSE light or SPIN light flashing', page 31).

Spin speed sounds slower than it should.

The clothes are unevenly distributed in the bowl, your *Smart Drive*™ has compensated by lowering the spin speed.

Machine is continually going out of balance.

Check the machine is level and does not rock (refer to page 3).

Too much water for load (refer to page 13).

Too much or too little water when filling on AUTO water level.

It still may be in the AUTO water level mode (refer to page 13).

Some loads do not suit AUTO water level, eg pillows, bedding, large bulky garments.
Manually select the water level.

Auto fill needs adjusting (refer to pages 22, 23 and 25).

Noises.

Banging – load is out of balance (refer pages 13, 16 and 26).

Other noises – refer page 28.

Small puddle of water coming from under the machine.

The water level is too high for the amount of clothes. This has caused excessive splashing.
Use a lower water level (refer to page 13).

Large bulky, garments (eg pillows, duvets) can cause splashing. Wash on DELICATE cycle (PRIDE model) or HAND WASH cycle (EXCELLENCE model) (refer to page 16).

If the problem persists contact your Fisher & Paykel Dealer or Authorised Repairer (refer to page 37)



34 Wash problems

Listed below are possible causes and solutions to some common wash problems.

Creasing.

Overloading the washer or dryer.

Choose an EASY IRON or HAND WASH cycle (EXCELLENCE model), or a DELICATE cycle (PRIDE model) as these cycles have been designed to minimise creasing.

Try selecting a slower spin speed.

Do not leave wet clothes to sit in the washer or laundry basket.

Poor soil removal.

Warm wash water is too cold. Refer to 'Changing pre-set options', page 24.

Not enough detergent for load size or amount of soil.

White clothes are better washed separately. Separate light and heavily soiled items, as clothes can pick up soil from dirty wash water.

Cold water wash is too cold (refer to 'Controlled cold', page 25, EXCELLENCE model only).

Select the wash temperature according to soil type. For example, blood and mud are better washed in cold water, while oily soils wash better in warmer water.

Overloading the washer.

Loads made up of articles of varying sizes will wash better (eg full loads of sheets may not wash as well).

Hard water requires more detergent than soft water.

Linting.

Wash lint givers (eg towels, flannelette sheets) separately from lint collectors (eg synthetic fabrics).

Overloading the washer.

Not enough detergent to hold the lint in suspension.

Overdrying in a dryer can cause a build-up of static electricity in synthetic fabrics and cause them to attract lint.

Detergent residue.

Overloading the washer.

Try using less detergent.

Some detergents need to be pre-dissolved, check the detergent instructions.

Cold ambient temperatures, cold washes and/or short agitation times may not let the detergent dissolve properly. Try pre-dissolving the detergent.

Black or grey marks on clothes.

A build up caused by the interaction of fabric softener and detergent can flake off and mark clothes (refer to 'Scrud' page 21).

Insufficient detergent, for the amount of soil on the clothes, can result in grey marks on clothes (refer to 'Detergent' page 20).



Dye transfer.

Wash and dry non-colourfast clothes separately.

Non-colourfast clothes left sitting in a washer or laundry basket can transfer dye to other clothes.

Tangling.

Washing with too much water (ie underloading) can cause the clothes to tangle around one another.

Do not load the washer by wrapping clothes around the agitator.



36 Manufacturer's Warranty

You automatically receive a 2 year Manufacturer's Warranty with the purchase of this Product covering parts and labour for servicing within the country of purchase.

Fisher & Paykel undertakes to

Repair or, at its option, replace without cost to the owner either for material or labour any part of the Product, the serial number of which appears on the product, which is found to be defective within TWO YEARS of the date of purchase.

This warranty DOES NOT cover

- A** Service calls which are not related to any defect in the Product. The cost of a service call will be charged if the problem is not found to be a Product fault. For example:
 - 1. Correcting the installation, eg removal of bottom packer and transit bolts (front loading washers), levelling the machine, adjustment of the drain to correct syphoning, noises, crossed, kinked or leaking inlet hose connections, turning on water, noises caused by the waterhammer or power supplies.
 - 2. Providing instruction on use of the product or changing the set-up of the product, eg instruction on correct use of detergents and fabric softeners.
 - 3. Replacing fuses in, or correcting house wiring or correcting house plumbing, eg unblocking drains.
 - 4. Correcting fault(s) caused by the user.
 - 5. Noise or vibration that is considered normal, eg spin sounds, user warning beeps.
 - 6. Correcting damage caused by pests, eg rats, cockroaches, etc.
 - 7. Water on the floor due to incorrect loading or excessive suds.
 - 8. Blocked pumps, removal of foreign objects/substances from the machine, including the pump and inlet hose filters, eg bra wires, bread tags, nails, grit, scrub, etc.
 - 9. Correcting corrosion or discolouration due to chemical attack.
- B** Defects caused by factors other than:
 - 1. Normal domestic use or
 - 2. Use in accordance with the Product's User Guide.
- C** Defects to the Product caused by accident, neglect, misuse or 'Act of God'.
- D** The cost of repairs carried out by non-authorized repairers or the cost of correcting such unauthorised repairs.
- E** Normal recommended maintenance as set out in the Product's User Guide.
- F** Repairs when the appliance has been dismantled, repaired or serviced by other than a Fisher & Paykel Authorised Repairer or the selling dealer.
- G** Pick-up and delivery.
- H** Transportation or travelling costs involved in the repair when the Product is installed outside the Fisher & Paykel Authorised Repairer's normal service area.

This Product has been designed for use in a normal domestic (residential) environment. This Product is not designed for commercial use (whatsoever). Any commercial use by a Customer will affect this Product's Warranty.

Service under this Manufacturer's Warranty must be provided by a Fisher & Paykel Authorised Repairer (refer to the 'Customer Care' section at the back of this book). Such service shall be provided during normal business hours. This Warranty certificate should be shown when making any claim.

Note

This Warranty is an extra benefit and does not affect your legal rights.

Please keep this User Guide in a safe place.



Before you call for service or assistance...

Check the things you can do yourself.
Refer to your User Guide and check:



- 1 Your appliance is correctly installed.
- 2 You are familiar with its normal operation.
- 3 You have read the problem solving at the back of the book.

If after checking these points you still need assistance, please refer to your nearest Fisher & Paykel Authorised Repairer, or contact us through our local website listed on the back cover.

In New Zealand if you need assistance...*

Call your Fisher & Paykel retailer who is trained to provide information on your appliance, or if we can be of any further help, please contact our Customer Care Centre,

Toll Free: 0800 FP CARE or 0800 37 2273 **Fax:** (09) 273 0656

Email: customer.care@fp.co.nz

Postal address: PO Box 58732, Botany, Manukau 2163

If you need service...*

Fisher & Paykel has a network of independent Fisher & Paykel Authorised Repairers whose fully trained technicians can carry out any service necessary on your appliance. Your dealer or our Customer Care Centre can recommend a Fisher & Paykel Authorised Repairer in your area.

In Australia if you need assistance...*

Call the Fisher & Paykel Customer Care Centre and talk to one of our Customer Care Consultants.

Toll Free: 1 300 650 590

Fax: (07) 3826 9298

Email: customer.care@fp.com.au

Postal Address: PO Box 798, Cleveland QLD 4163

If you need service...*

Fisher & Paykel has a network of qualified Fisher & Paykel Authorised Repairers responsible for servicing only Fisher & Paykel branded appliances. Our Customer Care Centre can recommend a qualified Fisher & Paykel Authorised Repairer in your area.

*If you call, write or contact our website please provide: your name and address, model number, serial number, date of purchase and a complete description of the problem. This information is needed in order to better respond to your request for assistance.

Product details can be found on the top left hand side of the console or back panel of the washer cabinet.

Product details

Fisher & Paykel Appliances, Ltd

Model/Serial No.

Date of Purchase _____

Purchaser _____

Dealer _____

Suburb _____

Town _____

Country _____



www.fisherpaykel.co.nz
www.fisherpaykel.com.au

Fisher & Paykel

Copyright © Fisher & Paykel 2009. All rights reserved.

The product specifications in this booklet apply to the specific products and models described at the date of issue. Under our policy of continuous product improvement, these specifications may change at any time. You should therefore check with your Dealer to ensure this booklet correctly describes the product currently available.

NZ AU PAC

F&P PN - 421384

09.2009