

WF8750LS(A/F/G/H/S/V/W/Z)

Washing Machine

user manual

imagine the possibilities

Thank you for purchasing this Samsung product.
To receive a more complete service, please
register your product at

www.samsung.com/register



sonline
.co
line appliance



features of your new samsung washing machine

Your new washing machine will change the way you feel about doing laundry. From its super-size capacity to its energy efficiency, the Samsung washing machine has all the features to turn a mundane chore into a pleasure.

- **Water Saving**

Designed to address concerns on water consumption. Less water is used per wash, while continuing to deliver a clean and effective washing performance. It is certified by the WELS (Water Efficiency Labelling and Standards) scheme in Australia.

- **Child Lock**

The Child Lock function ensures that curious little hands are kept from interfering with your washing program.

- **Wool Certified**

The machine has been tested and passed the required Woolmark Company specification for machine washable wool products.

Fabrics should be washed according to the instructions on the garment label as specified by Woolmark and Samsung.

- **Delay End**

Delay a cycle for up to 19 hours in one-hour increments and increase the convenience of using your washing machine especially when you have to go out.

- **Quick Wash**

No time to lose! Less than 30 minutes wash will give you time to run out before it's too late. Our 29 minute Quick Wash program can be the solution to your busy life. Now you can wash your favourite clothes in only 29 minutes!

- **Delicates & Hand Wash Program**

Special care can be determined by the appropriate temperature, the gentle wash action and the appropriate amount of water.

- **Ceramic Heater for Durability & Energy Saving (selected models)**

Our truly innovative Ceramic Heater is more durable than regular heaters.

Plus, it eliminates the scaling caused by hard water and resulting increased consumption energy.



- **Wide door**

Extra wide door aperture for convenient viewing! Easily add and remove laundry, especially for large sized laundry items such as bedding, towels etc.

This manual contains important information on the installation, use, and care of your new Samsung washing machine. Refer to it for descriptions of the control panel, instructions on how to use the washing machine, and tips for making the most of its state-of-the-art features and functions. The “**Troubleshooting and information codes**” section on page 37 tells you what to do if something goes wrong with your new washing machine.



appliancesonline
.co

Australia's largest online appliance retailer
features _3



safety information

Congratulations on your new Samsung ActivFresh™ washer. This manual contains important information on the installation, use and care of your appliance. Please take time to read this manual to take full advantage of your washer's many benefits and features.

WHAT YOU NEED TO KNOW ABOUT SAFETY INSTRUCTIONS













Please read this manual thoroughly to ensure that you know how to safely and efficiently operate the extensive features and functions of your new appliance and retain it at a safe place near the appliance for your future reference. Use this appliance only for its intended purpose as described in this instruction manual.

Warnings and Important Safety Instructions in this manual do not cover all possible conditions and situations that may occur. It is your responsibility to use common sense, caution, and care when installing, maintaining, and operating your washer.

Because these following operating instructions cover various models, the characteristics of your washer may differ slightly from those described in this manual and not all warning signs may be applicable. If you have any questions or concerns, contact your nearest service center or find help and information online at www.samsung.com.

IMPORTANT SAFETY SYMBOLS AND PRECAUTIONS

What the icons and signs in this user manual mean:

 WARNING	Hazards or unsafe practices that may result in severe personal injury, death and/or property damage.
 CAUTION	Hazards or unsafe practices that may result in personal injury and/or property damage.
 CAUTION	To reduce the risk of fire, explosion, electric shock, or personal injury when using your washer, follow these basic safety precautions:
 CAUTION	To reduce the risk of fire or explosion, follow these basic precautions.
	Do NOT attempt.
	Do NOT disassemble.
	Do NOT touch.
	Follow directions explicitly.
	Unplug the power plug from the wall socket.
	Make sure the machine is grounded to prevent electric shock.
	Call the service centre for help.
	Note

These warning signs are here to prevent injury to you and others.

Please follow them explicitly.

After reading this section, keep it in a safe place for future reference.



appliancesonline
.co

Australia's largest online appliance retailer



- ★ Read all instructions before using the appliance.

As with any equipment using electricity and moving parts, potential hazards exist. To safely operate this appliance, become familiar with its operation and exercise care when using it.



WARNING

This appliance is not intended for use by persons (including children) with reduced physical, sensory or mental capabilities, or lack of experience and knowledge, unless they have been given supervision or instruction concerning use of the appliance by a person responsible for their safety.

Children should be supervised to ensure that they do not play with the appliance.



appliancesonline.co

Australia's largest online appliance retailer
safety information _5



safety information



SEVERE WARNING SIGNS FOR INSTALLATION

- ★ It is recommended that The installation of this appliance be performed by a qualified technician or service company.
 - Failure to do so may result in electric shock, fire, an explosion, problems with the product, or injury.
 - The shipping bolts must be removed before operation of the machine, failure to remove the bolts may cause damage to the machine.

The appliance is heavy, take care when lifting it

Plug the power cord into an AC 220~240V/50Hz/10A wall socket or portable electric outlet device for connecting this appliance and use the socket for this appliance only. In addition, do not use an extension cord.

- The electrical outlet should be protected from splashes and water ingress.
- Sharing a wall socket with other appliances using a power strip or extending the power cord may result in electric shock or fire.
- Ensure that the power voltage, frequency and current are the same as those of the product specifications. Failure to do so may result in electric shock or fire. Plug the power plug into the wall socket firmly.

Remove all foreign substances such as dust or water from the power plug terminals and contact points using a dry cloth on a regular basis.

- Unplug the power plug and clean it with a dry cloth.
- Failure to do so may result in electric shock or fire.

Keep all packaging materials well out of the reach of children, as packaging materials can be dangerous to children.

- If a child places a bag over its head, it may result in suffocation.
- All packaging materials should be disposed off in an environmentally suitable manner.

If the appliance or power plug or power cord is damaged, contact your supplier or nearest service centre.



This appliance must be properly grounded.

Do not ground the appliance to a gas pipe, plastic water pipe, or telephone line.

- This may result in electric shock, fire, an explosion, or problems with the product
- Never plug the power cord into a socket that is not grounded correctly and make sure that it is in accordance with local and national codes.



Do not install this appliance near a heater, inflammable material.

Do not install this appliance in a humid, oily or dusty location, in a location exposed to direct sunlight and water (rain drops).

Do not install this appliance in a location of low temperature

- Frost may cause tubes to burst

Do not install this appliance in a location where gas may leak.

- This may result in electric shock or fire.

Do not use an electric transformer.

- It may result in electric shock or fire.

Do not use a damaged power plug, damaged power cord or loose wall socket.

- This may result in electric shock or fire.



appliancesonline.com.au

Australia's largest online appliance retailer



Do not pull or excessively bend the power cord.

Do not twist or tie the power cord.

Do not hook the power cord over a metal object, place a heavy object on the power cord, insert the power cord between objects, or push the power cord into the space behind the appliance.

- This may result in electric shock or fire.

Do not pull the power cord, when unplugging the power plug.

- Unplug the power plug by holding the plug.
- Failure to do so may result in electric shock or fire.

Do not lay the power cord and tubes where you may fall over them.



CAUTION SIGNS FOR INSTALLATION

- ★ This appliance should be positioned in such a way that the power plug is easily accessible in case of an emergency situation.

Install your appliance on a level and hard floor that can support its weight.

- Failure to do so may result in abnormal vibrations, moves, noise, or problems with the product.



SEVERE WARNING SIGNS FOR USING

- ★ If the appliance is flooded, cut the water supply and power immediately and contact your nearest service centre.

- Do not touch the power plug with wet hands
- Failure to do so may cause electric shock

If the appliance generates a strange noise, a burning smell or smoke, unplug the power plug immediately and contact your nearest service centre.

- Failure to do so may result in electric shock or fire.

In the event of a gas leak (such as propane gas, LP gas, etc.), ventilate the room immediately without touching the power plug. Do not touch the appliance or power cord.

- Do not use a ventilating fan.
- A spark may result in an explosion or fire.

Do not let children play in or on the washer. In addition, when disposing of the appliance, remove the washer door lever.

- If trapped inside, the child may become trapped and suffocate to death.

Make sure to remove the packaging (sponge, styrofoam) attached to the bottom of the washer before using it.



appliancesonline.co

Australia's largest online appliance retailer

safety information _7



safety information

 Do not wash items contaminated with gasoline, kerosene, benzene, paint thinner, alcohol or other flammable or explosive substances.

- This may result in electric shock, fire or an explosion.

Do not open the washer door by force while it is operating (high-temperature washing/drying/spinning).

- Water flowing out of the washer may result in burns or cause the floor to be slippery.

This may result in injury.

- Opening the door by force may result in damage to the product or injury.

Do not insert your hand under the washer.

- This may result in injury.

Do not touch the power plug with wet hands.

- This may result in electric shock.

Do not turn the appliance off by unplugging the power plug while an operation is in progress.

- Plugging the power plug into the wall socket again may cause a spark and result in electric shock or fire.

Do not let children or infirm persons use this washer unsupervised. Do not let children climb in the appliance

- Failure to do so may result in electric shock, burns or injury.

Do not insert your hand or a metal object under the washer while it is operating.

- This may result in injury.

Do not unplug the appliance by pulling at the power cord, always grip the plug firmly and pull straight out from the outlet.

- Damage to the cord may cause short-circuit, fire and/or electric shock

 Do not attempt to repair, disassemble, or modify the appliance yourself.

- Do not use any fuse(such as copper, steel wire, etc.) other than the standard fuse.
- When repairing or reinstalling the appliance is required, contact your nearest service centre.
- Failure to do so may result in electric shock, fire, problems with the product, or injury.

 If any foreign substance such as water has entered the appliance, unplug the power plug and contact your nearest service centre.

- Failure to do so may result in electric shock or fire.

When the water supply hose comes loose from the faucet and floods the appliance, unplug the power plug.

- Failure to do so may result in electric shock or fire.

Unplug the power plug when the appliance is not being used for long periods of time or during a thunder/lightning storm.

- Failure to do so may result in electric shock or fire.



CAUTION SIGNS FOR USING

 When the washer is contaminated by a foreign substance such as detergent, dirt, food waste, etc., unplug the power plug and clean the washer using a damp and soft cloth.

- Failure to do so may result in discoloration, deformation, damage or rust.

The front glass may be broken by a strong impact. Take care when using the washer.

- When the glass is broken, it may result in injury.

After a water supply failure or when reconnecting the water supply hose, open the faucet slowly.

Open the faucet slowly after a long period of non-use.

- The air pressure in the water supply hose or the water pipe may result in damage to a part or in water leakage.

If a drain error occurs during an operation, check if there is a draining problem.

- If the washer is used when it is flooded because of a draining problem, it may result in electric shock or fire due to electric leakage.

Insert the laundry into the washer completely so that laundry does not get caught in the door.

- If laundry gets caught in the door, it may result in damage to the laundry or the washer, or result in water leakage.

Ensure that the faucet is turned off when the washer is not being used.

- Ensure that the screw on the water supply hose connector is properly tightened.
- Failure to do so may result in property damage or injury.

Check if the rubber seal is not contaminated by foreign substances (waste, thread, etc).

- If the door is not closed completely, it may result in water leakage.

Open the faucet and check if the water supply hose connector is firmly tightened and that there is no water leaking before using the product.

- If the screws or the water supply hose connector are loose, it may result in water leakage.

To reduce the risk of fire or explosion:

- Under certain conditions, hydrogen gas may be produced in a hot water system such as your hot water heater that has not been used for two weeks or more. **HYDROGEN GAS IS EXPLOSIVE.** If your hot water system has not been used for two weeks or more, turn on all hot water taps in your home, and let the water flow for several minutes before using your washing machine. This will release any hydrogen gas build-up. Since hydrogen gas is flammable, do not smoke or light an open flame during this time. Ventilate the room immediately without touching the power plug if there is a gas leak.



appliancesonline.co

Australia's largest online appliance retailer

safety information 9

safety information

 Do not stand on top of the appliance or place objects (such as laundry, lighted candles, lighted cigarettes, dishes, chemicals, metal objects, etc.) on the appliance.

- This may result in electric shock, fire, problems with the product, or injury.

Do not spray volatile material such as insecticide onto the surface of the appliance.

- As well as being harmful to humans, it may also result in electric shock, fire or problems with the product.

Do not place an object that generates a electromagnetic field near the washer.

- This may result in injury due to a malfunction.

Since the water drained during a high-temperature wash or drying cycle is hot, do not touch the water.

- This may result in burns or injury.

Do not wash, spin or dry water-proof seats, mats or clothing (*) unless your appliance has a special program for washing these items.

- Do not wash thick, hard mats even if the washer mark is on the care label.
- This may result in injury or damage to the washer, walls, floor or clothing due to abnormal vibrations.

* Woollen bedding, rain covers, fishing vests, ski pants, sleeping bags, diaper covers, sweat suits, and bicycle, motor cycle, car covers, etc.

Do not operate the washer when the detergent box is removed.

- This may result in electric shock or injury due to water leakage.

Do not touch the inside of the tub during or just after drying as it is hot.

- This may result in burns.

Do not insert your hand into the detergent box after opening it.

- This may result in injury as your hand may be caught by the detergent input device. Do not place any objects (such as shoes, food waste, animals) other than laundry into the washer.
- This may result in damage to the washer, or injury and death in the case of pets due to the abnormal vibrations.

Do not press the buttons using sharp objects such as pins, knives, fingernails, etc.

- This may result in electric shock or injury.

Do not wash laundry contaminated by oils, creams or lotions usually found in skincare shops or massage clinics.

- This may result in the rubber seal becoming deformed and water leakage.

Do not leave metal objects such as a safety pin or hair pin, or bleach in the tub for long periods of time.

- This may cause the tub to rust.
- If rust starts appearing on the surface of the tub, apply a cleansing agent (neutral) to the surface and use a sponge to clean it. Never use a metal brush.

Do not use dry cleaning detergent directly and do not wash, rinse, or spin laundry contaminated by dry cleaning detergent.

- This may result in spontaneous combustion or ignition due to the heat of the oxidation of the oil.

Do not use hot water from water cooling/heating devices.

- This may result in problems with the washer.





Do not use natural hand-washing soap for the washer.

- If it hardens and accumulates inside the washer, it may result in problems with the product, discoloration, rust or bad odors.

Do not wash large laundry items such as bedding in the washing net.

- Place socks and brassieres into the washing net and wash them with the other laundry.
- Failure to do so may result in injury due to abnormal vibrations.

Do not use hardened detergent.

- If it accumulates inside the washer, it may result in water leakage.

For washing machines with ventilation openings in the base, ensure that the opening is not obstructed by carpet or any other obstacles.

Make sure that the pockets of all clothing to be washed are empty.

- Hard, sharp objects, such as coins, safety pins, nails, screws, or stones can cause extensive damage to the appliance.

Do not wash clothing with large buckles, buttons, or other heavy metal.



WARNING

SEVERE WARNING SIGNS FOR CLEANING



Do not clean the appliance by spraying water directly onto it.
Do not use benzene, thinner or alcohol to clean the appliance.

- This may result in discoloration, deformation, damage, electric shock or fire.

Before cleaning or performing maintenance, unplug the appliance from the wall socket.

- Failure to do so may result in electric shock or fire.



appliancesonline
.co

Australia's largest online appliance retailer
safety information _11



contents

SETTING UP YOUR WASHING MACHINE	13	13	Checking the parts
		14	Meeting installation requirements
		14	Electrical supply and grounding
		14	Water Supply
		15	Drain
		15	Flooring
		15	Surrounding temperature
		15	Alcove or closet installation
		15	Installing your washing machine
		20	Environment
WASHING A LOAD OF LAUNDRY	21	21	Washing for the first time
		21	Basic instructions
		22	Using the control panel
		24	Child lock
		24	Sound off
		24	Delay End
		25	Washing clothes using the cycle selector
		26	Washing clothes manually
		26	Laundry guidelines
		28	Detergent and additives information
		28	Which detergent to use
		28	Detergent drawer
CLEANING AND MAINTAINING YOUR WASHING MACHINE	29	29	Draining the washing machine in an emergency
		29	Cleaning the exterior
		30	Cleaning the detergent drawer and drawer recess
		31	Cleaning the debris filter
		31	Cleaning the water hose mesh filter
		32	Repairing a frozen washing machine
		32	Storing your washing machine
TROUBLESHOOTING AND INFORMATION CODES	33	33	Check these points if your washing machine...
		34	Information codes
CYCLE CHART	35	35	Cycle chart
APPENDIX	36	36	Fabric care chart
		36	Protecting the environment
		36	Declaration of conformity
		37	Specifications

setting up your washing machine

Be sure to have your installer follow these instructions closely so that your new washing machine works properly and so that you're not at risk of injury when doing laundry.

CHECKING THE PARTS

Carefully unpack your washing machine, and make sure you've received all of the parts shown below. If your washing machine was damaged during shipping, or if you do not have all of the parts, contact Samsung Customer Service or your Samsung dealer.

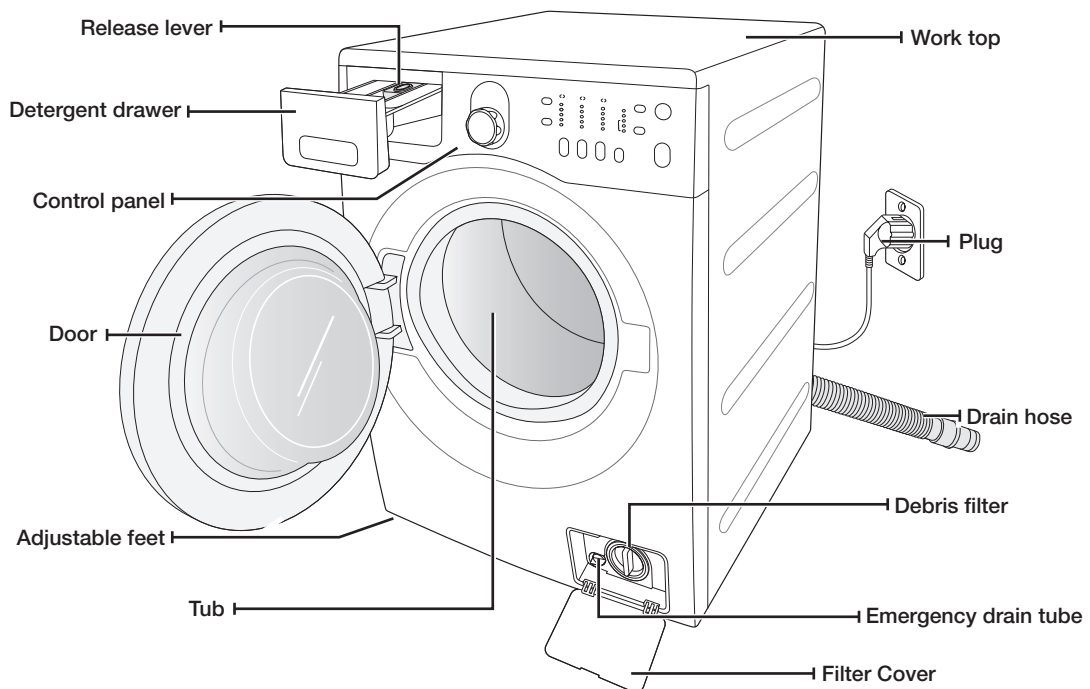

Spanner

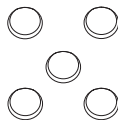

Bolt hole covers



Water supply hose



Hose guide

setting up your washing machine

MEETING INSTALLATION REQUIREMENTS

Electrical supply and grounding

 Never use an extension cord.
WARNING Use only the power cord that comes with your washing machine.

When preparing for installation, ensure that your power supply offers:

- 220V~240V 50Hz 10 AMP fuse or circuit breaker
- Individual branch circuit serving only your washing machine

Your washing machine must be grounded. If your washing machine malfunctions or breaks down, grounding will reduce the risk of electric shock by providing a path of least resistance for the electric current.

Your washing machine comes with a power cord having a three-prong grounding plug for use in a properly installed and grounded outlet.

 Never connect the ground wire to plastic plumbing lines, gas lines, or hot water pipes.

Improperly connecting the equipment-grounding conductor can result electrical shock. Check with a qualified electrician or serviceman if you are unsure if the washing machine is properly grounded. Do not modify the plug provided with the washing machine. If it does not fit the outlet, have a proper outlet installed by a qualified electrician.

Water Supply

Your washing machine will fill properly when your water pressure is 50 kPa ~ 800 kPa. Water pressure less than 50 kPa may cause water valve failure, not allowing the water valve to shut off completely. Or, it may take the washing machine longer to fill than what the controls allow, resulting in your washing machine turning off. (A fill-time limit, designed to prevent overflows/flooding if an internal hose becomes loose, is built into the controls.)

The water taps must be within 4 feet (122cm) of the back of your washing machine for the provided inlet hoses provided to reach your washing machine.

 Most plumbing supply stores sell inlet hoses of various lengths up to 10 feet (305cm) long.

You can reduce the risk of leaks and water damage by:

- Making water taps easily accessible.
- Turning off taps when the washing machine is not in use.
- Periodically checking for leaks at water inlet hose fittings.

 Before using your washing machine for the first time, check all connections at the water valve and taps for leaks.
WARNING



Drain

Samsung recommends a standpipe height of 18 in (46 cm). The drain hose must be routed through the drain hose clip to the standpipe. The standpipe must be large enough to accept the outside diameter of the drain hose. The drain hose is attached at the factory.

Flooring

For best performance, your washing machine must be installed on a solidly constructed floor. Wood floors may need to be reinforced to minimize vibration and/or unbalanced loads. Carpeting and soft tile surfaces are contributing factors to vibrations and the tendency for your washing machine to move slightly during the spin cycle.

Never install your washing machine on a platform or poorly supported structure.

Surrounding temperature

Do not install your washing machine in areas where water may freeze, since your washing machine always retains some water in its water valve, pump, and hose areas. Frozen water in the lines can cause damage to belts, the pump, and other components.

Alcove or closet installation

To operate safely and properly, your new washing machine requires minimum clearances of:

Sides – 25 mm

Rear – 51 mm

Top – 25 mm

Front – 465 mm

If both the washing machine and a dryer are installed together, the front of the alcove or closet must have at least 465 mm unobstructed air opening. Your washing machine alone does not require a specific air opening.

INSTALLING YOUR WASHING MACHINE

STEP 1

Selecting a location



Before you install the washing machine, make sure the location:

- Has a hard, level surface without carpeting or flooring that may obstruct ventilation
- Is away from direct sunlight
- Has adequate ventilation
- Will not be freezing (below 32 °F or 0 °C)
- Is away from heat sources such as oil or gas
- Has enough space so that the washing machine doesn't stand on its power cord



appliancesonline.com

Australia's largest online appliance retailer

setting up your new washing machine _15



setting up your washing machine

STEP 2

Removing the shipping bolts

Before installing the washing machine, you must remove the five shipping bolts from the back of the unit.

1. Loosen all the bolts with the supplied wrench.

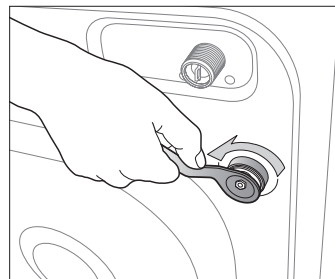

2. Hold the bolt with the spanner and pull it through the wide section of the hole. Repeat for each bolt.

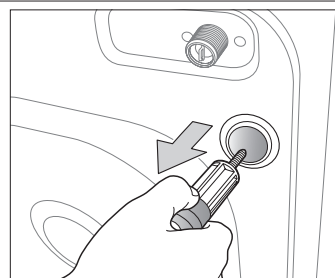

3. Fill the holes with the supplied plastic covers.

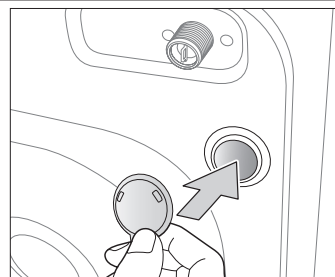

4. Store the shipping bolts away safely in case you have to move the washing machine in the future.



WARNING Packaging materials can be dangerous to children; keep all packaging material (plastic bags, polystyrene, etc.) well out of the reach of children.

STEP 3

Adjusting the levelling feet

 When installing your washing machine, ensure that the power plug, the water supply and the drain are easily accessible.

1. Slide the washing machine into position.

2. Level your washing machine by turning the leveling feet in and out as necessary by hand.

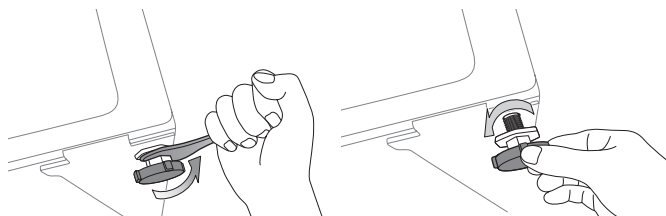

3. When your washing machine is level, tighten the nuts using the wrench supplied with your washing machine.

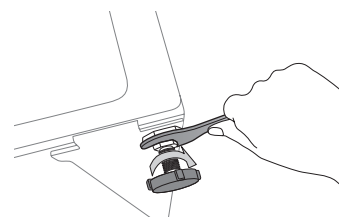

STEP 4

Connecting the water and drain

Connecting the water supply hose

1. Take the L-shaped arm fitting for the cold water supply hose and connect it to the cold water supply intake on the back of the machine. Tighten by hand.

 The water supply hose must be connected to the washing machine at one end and to the water tap at the other. Do not stretch the water supply hose. If the hose is too short, replace the hose with a longer, high pressure hose.

2. Connect the other end of the cold water supply hose to your sink's cold water tap and tighten it by hand. If necessary, you can reposition the water supply hose at the washing machine end by loosening the fitting, rotating the hose, and retightening the fitting.

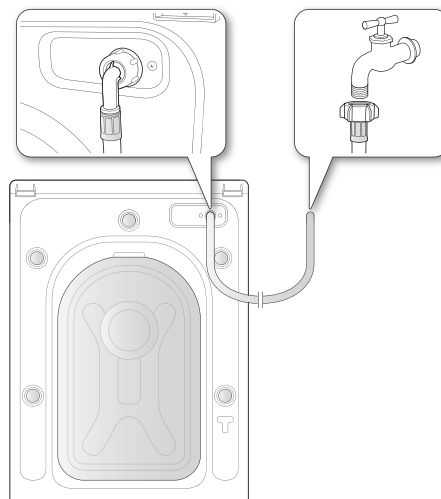

For selected models with an additional hot water intake:

1. Take the red L-shaped arm fitting for the hot water supply hose and connect it to the hot water supply intake on the back of the machine. Tighten by hand.
2. Connect the other end of the hot water supply hose to your sink's hot water tap and tighten it by hand.
3. Use a Y-piece if you only want to use cold water.

setting up your washing machine

Connecting the water supply hose (selected models)

1. Remove the adaptor from the water supply hose.

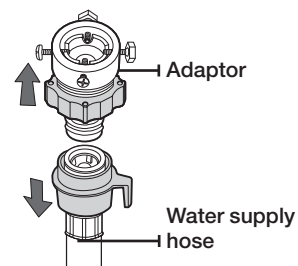

2. First, using a '+' type screwdriver, loosen the four screws on the adaptor. Next, take the adaptor and turn part (2) following the arrow until there is a 5 mm gap.

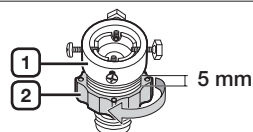

3. Connect the adaptor to the water tap by tightening the screws firmly while lifting the adaptor upwards. Turn part (2) following the arrow and connect (1) and (2).

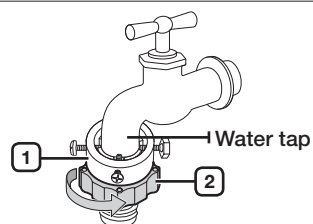

4. Connect the water supply hose to the adaptor. When you release part (3), the hose automatically connects to the adaptor making a 'click' sound.

-  After you have connected the water supply hose to the adaptor, ensure that it is connected correctly by pulling the water supply hose downwards.

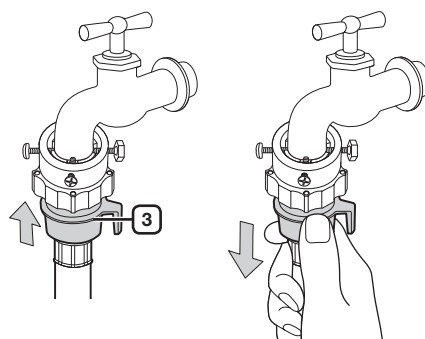

5. Connect the other end of the water supply hose to the inlet water valve at the rear of the washing machine. Screw the hose clockwise all the way in.

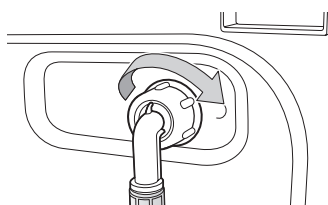



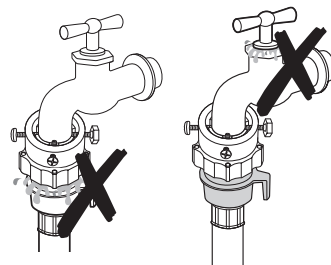

6. Turn on the water supply and ensure that no water leaks from the water valve, tap or adaptor. If there is a water leak, repeat the previous steps.

 Do not use your washing machine if there is a water leak.
WARNING This may cause electric shock or injury.

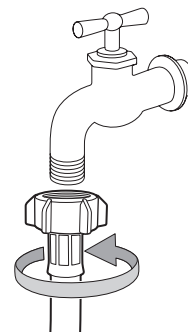

- If the water tap has a screw type tap, connect the water supply hose to the tap as shown.



-  Use the most conventional type of tap for the water supply. In case the tap is square or too big, remove the spacing ring before inserting the tap into the adaptor.



setting up your washing machine

Connecting the drain hose

The end of the drain hose can be positioned in three ways:

- 1. Over the edge of a wash basin:** The drain hose must be placed at a height of between 60 and 90 cm. To keep the drain hose spout bent, use the supplied plastic hose guide. Secure the guide to the wall with a hook or to the tap with a piece of string to prevent the drain hose from moving.

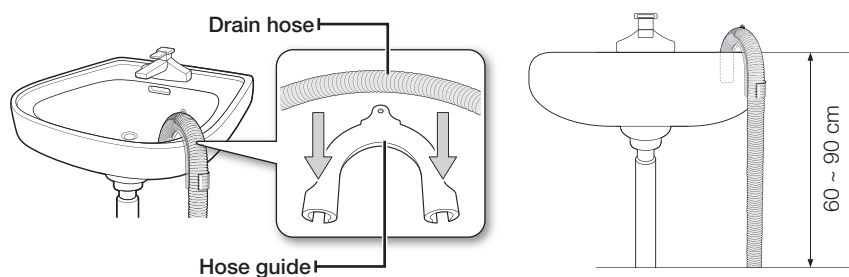

- 2. In a sink drain pipe branch:** The drain pipe branch must be above the sink siphon so that the end of the hose is at least 60 cm above the ground.
- 3. In a drain pipe:** We recommend using a 65 cm high vertical pipe; it must be no shorter than 60 cm and no longer than 90 cm.

STEP 5

Powering your washing machine

Plug the power cord into a wall sockets, a 220~240V 50 Hz approved electrical outlet protected by a 10-amp fuse or comparable circuit breaker. (For more information on electrical and grounding requirements, see page 18.)

ENVIRONMENT

Please dispose of the packaging materials for this product in an "environmentally friendly" manner. For further detail, please contact your local area authority.

washing a load of laundry

With your new Samsung washing machine, the hardest part of doing laundry will be deciding which load to wash first.

WASHING FOR THE FIRST TIME

 Before washing laundry for the first time, you must run a complete empty cycle (i.e. no laundry).

1. Press the **Power** button.
2. Add a little detergent to the detergent compartment ② in the detergent drawer.
3. Turn on the water supply to the washing machine.
4. Press the **Start/Pause** button.

 This will remove any water that might be left over in the machine from the manufacturer's test run.

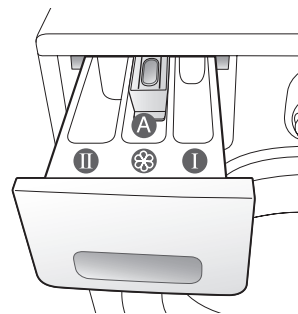

Compartment ①: Detergent for prewash, or starch.

Compartment ②: Detergent for the main wash, water softener, pre-soaking agent, bleach and stain removal product.

Compartment ③: Additives, e.g. fabric softener or former (fill no higher than lower edge (MAX) of "A")

BASIC INSTRUCTIONS

1. Load your laundry into the washing machine.

 **WARNING** Do not overload the washing machine. To determine the load capacity for each type of laundry, refer to the chart on page 31.



-  • Make sure that laundry is not caught in the door, as this may cause a water leak.
- Washing detergent may remain in the front rubber part of the washer after a wash cycle. Remove any remaining detergent, as they may cause a water leak.
- Do not wash water-proofed items.
2. Close the door until it latches.
 3. Turn the power on.
 4. Add detergent and additives to the dispenser drawer.
 5. Select the appropriate cycle and options for the load.
The Wash Indicator light will illuminate and the estimated cycle time will appear in the display.
 6. Press the **Start/Pause** button.





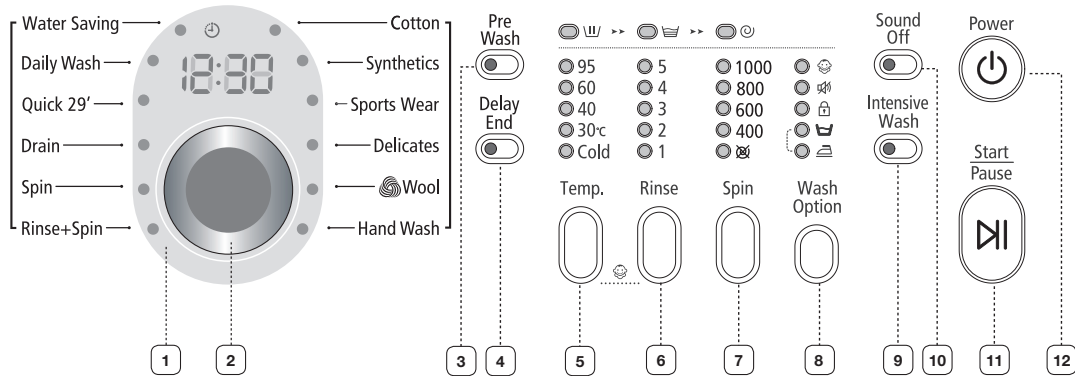



washing a load of laundry

USING THE CONTROL PANEL



<p>1 DIGITAL GRAPHIC DISPLAY</p>	<p>Displays the remaining wash cycle time, all cycle information, and error messages.</p>
<p>2 CYCLE SELECTOR</p>	<p>Select the tumble pattern and spin speed for the cycle.</p> <p> For detailed information, refer to “Washing clothes using the cycle selector” (see page 29).</p> <p>Cotton - For averagely or lightly soiled cottons, bed linen, table linen, underwear, towels, shirts, etc.</p> <p>Synthetics - For lightly soiled blouses, shirts, etc., made of polyester (diolen, trevira), polyamide (perlon, nylon) or other similar blends.</p> <p>Sports Wear - Use for water-proofed or proofed garments to keep their good looks and fresh feel.</p> <p>Delicates - For sheer fabrics, brassieres, lingerie, dresses, shirts and blouses. For best results, use liquid detergent.</p> <p>Wool - Only for machine-washable wool. A load should be less than 2.0 kg.</p> <p> The wool wash cycle of this machine has been approved by Woolmark for the washing of machine-washable Woolmark products provided that the products are washed according to the instructions on the garment label and those issued by the manufacturer of this washing machine, M0509 (Certificate Number issued by IWS NOM INEE Co., Ltd.)</p> <p>Handwash - A very light wash cycle as gentle as a hand wash.</p> <p>Water Saving - This is a specially designed course that enables you to wash laundry effectively with the minimum amount of water. Water Saving, 3 rinses, 40°C, Intensive, 1000rpm spin is recommended for a normally soiled cotton load.</p> <p>Daily Wash - Use for everyday items such as underwear and shirts.</p> <p>Quick 29' - For lightly soiled garments that you require quickly.</p> <p>Drain - Just drain the water from washing machine without spinning.</p> <p>Spin - Performs an additional spin cycle to remove more water.</p> <p>Rinse + Spin - Use for a load that needs rinsing only or to add rinse-added fabric softener to a load.</p>



3	PREWASH SELECTION BUTTON	Press this button to select pre-wash. Pre-wash is only available with: Cotton, Synthetics, Sports Wear, Water Saving, Daily Wash.
4	DELAY START SELECTION BUTTON	Press this button repeatedly to cycle through the available Delay End options (from 3 hours to 19 hours in one hour increments). The hour displayed indicates the time when the wash cycle will be finished.
5	TEMPERATURE SELECTION BUTTON	Press this button repeatedly to cycle through the available water temperature options: (Cold Water  , 30 °C, 40 °C, 60 °C and 95 °C).
6	RINSE SELECTION BUTTON	Press this button to add additional rinse cycles. The maximum number of rinse cycles is five.
7	SPIN SELECTION BUTTON	Press the button repeatedly to cycle through the available speeds for the spin cycle.
		<table border="1" data-bbox="556 758 1264 799"> <tr> <td data-bbox="565 758 898 799">WF8750</td> <td data-bbox="905 758 1264 799">, , 400, 600, 800, 1000 rpm</td> </tr> </table> <p data-bbox="556 810 1264 866">“No spin ” - The laundry remains in the drum and no spin cycle is performed after the final drain. “Rinse Hold ” -The laundry remains soaking in the final rinse water. Before the laundry can be unloaded, either a Drain or Spin cycle must be performed.</p>
WF8750	 ,  , 400, 600, 800, 1000 rpm	
8	WASH OPTION SELECTION BUTTON	<p data-bbox="556 965 1264 1021">Press this button repeatedly to cycle through the wash options: Easy Iron → Soak → Easy Iron + Soak → off</p> <p data-bbox="556 1023 1264 1079">“Easy Iron”: Use this option to prepare your laundry so that it can be easily ironed.</p> <p data-bbox="556 1081 1264 1137">“Soak”: Use this option to effectively remove stains from your laundry by soaking your laundry.</p> <ul data-bbox="556 1139 1264 1307" style="list-style-type: none"> • The Soak function is performed 13 minutes into the wash cycle. • The Soak function continues for 30 minutes with six cycles, where one cycle is a soak cycle that spins for 1 minute and stands still for 4 minutes. • The Soak function is only available for the following wash programs: Cotton, Synthetics, Sports wear, Water Saving, Daily wash.
9	INTENSIVE WASH SELECTION BUTTON	Press this button when the laundry is heavily soiled and needs to be washed intensively. The cycle time is increased for each cycle.
10	SOUND OFF BUTTON	<p data-bbox="556 1384 1264 1440">The sound can be turned off for all courses. When this function is selected, the sound is turned off for all cycles.</p> <ul data-bbox="556 1442 1264 1560" style="list-style-type: none"> • When the Sound off function is activated, the lamp on the Sound Off button and the control panel are illuminated. • When the Sound off function is deactivated, a buzzer will go off, and the lamp on the button and the control panel is turned off.
11	START/PAUSE SELECTION BUTTON	Press to pause and restart a cycle.
12	POWER BUTTON	<p data-bbox="556 1636 1264 1692">Press it once to turn your washing machine on, press it again to turn your washing machine off.</p> <p data-bbox="556 1694 1264 1750">If the washing machine is left on for more than 10 minutes without any buttons being touched, the power automatically turns off.</p>



washing a load of laundry

Child lock

The Child Lock function allows you to lock the buttons so that the wash cycle you've chosen can't be changed.

Activating/Deactivating

If you want to activate or deactivate the Child Lock function, press the **Temp.** and **Rinse** buttons at the same time for 3 seconds. "Child Lock" will be lit when this feature is activated.

- When the Child Lock function is activated, only the **Power** button works. The Child Lock function remains on even after the power is turned on and off or after the disconnecting and reconnecting the power cord.

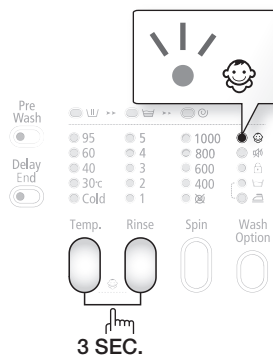

Sound off

The Sound Off function can be selected during all courses. When this function is selected, sound is turned off for all courses. Even if the power is turned on and off repeatedly, the setting is retained.

Activating/Deactivating

If you want to activate or deactivate the Sound Off function, press the **Sound OFF** button. The lamp on the **Sound Off** button and the control panel will be lit when this feature is activated.

Delay End

You can set the washing machine to finish your wash automatically at a later time, choosing a delay of between 3 to 19 hours (in 1 hour increments). The hour displayed indicates the time at which the wash will be finished.

- Manually or automatically set your washing machine according to the type of laundry you are washing.
- Press the **Delay End** button repeatedly until the delay time is set.
- Press the **Start/Pause** button. The "Delay End" indicator will be lit, and the clock will begin counting down until it reaches the set time.
- To cancel a Delay End function, press the **Power** button and then turn the washing machine on again.



Washing clothes using the cycle selector

Your new washing machine makes washing clothes easy, using Samsung's "Fuzzy Control" automatic control system. When you select a wash program, the machine will set the correct temperature, washing time, and washing speed.

1. Turn on your sink's water tap.
 2. Press the **Power** button.
 3. Open the door.
 4. Load the articles one at a time loosely into the drum, without overfilling it.
 5. Close the door.
 6. Add detergent, softener, and pre-wash detergent (if necessary) into the appropriate compartments.
-  Pre-wash is only available when selecting the Cotton, Synthetics, Sports Wear, Water Saving, and Daily Wash cycles. It is only necessary if your clothing is heavily soiled.
7. Use the **Cycle Selector** to select the appropriate cycle according to the type of material: Cotton, Synthetics, Sports Wear, Delicates, Wool, Hand Wash, Water Saving, Daily Wash, Quick 29'. The relevant indicators will illuminate on the control panel.
 8. At this time, you can control the wash temperature, the amount of rinses, the spinning speed, and the delay time by pressing the appropriate option button.
 9. Press the **Start/Pause** button and the wash will begin. The process indicator will light up and the remaining time for the cycle will appear in the display.

Pause Option

Within 5 minutes of starting a wash, it is possible to add/remove laundry items.

1. Press the **Start/Pause** button to unlock the door.
-  The door cannot be opened when the water is too HOT or the water level is too HIGH.
2. After closing the door, press the **Start/Pause** button to restart the wash.

When the cycle is finished:

After the total cycle has finished, the power will turn off automatically.

1. Open the door.
2. Remove laundry.



washing a load of laundry

Washing clothes manually

You can wash clothes manually without using the Cycle Selector.

1. Turn the water supply on.
2. Press the **Power** button on the washing machine.
3. Open the door.
4. Load the articles loosely into the drum one at a time, without overfilling it.
5. Close the door.
6. Add detergent and, if necessary, softener or prewash detergent, into the appropriate compartments.
7. Press the **Temp.** button to select the temperature. (Cold water, 30 °C, 40 °C, 60 °C, 95 °C)
8. Press the **Rinse** button to select the required number of rinse cycles.
The maximum number of rinse cycles is five.
The wash duration is increased accordingly.
9. Press the **Spin** button to select the spin speed.
The rinse hold function allows you to remove items that are still wet from the washing machine. (☒ : No Spin, ☐ : Rinse Hold)
10. Press the **Delay End** button repeatedly to cycle through the available Delay End options (from 3 hour to 19 hours in one hour increments). The hour displayed indicates the time at which the wash will be finished.
11. Press the **Start/Pause** button and the machine will begin the cycle.

LAUNDRY GUIDELINES

Follow these simple guidelines for the cleanest laundry and the most efficient wash.

 Always check the Care label on clothing before washing.

Sort and wash your laundry according to the following criteria:

- Care Label: Sort laundry into cotton, mixed fibres, synthetics, silks, Wool and rayons.
- Colour: Divide whites and colours. Wash new colour items separately.
- Size: Placing items of different sizes in the same load will improve the wash action.
- Sensitivity: Wash delicate items separately, using the Delicate wash cycle for pure, new woollen items, curtains and silk articles. Check the labels on the items you are washing or refer to the fabric care chart in the appendix.

Emptying pockets

Before each wash, empty all the pockets of your laundry. Small, irregularly shaped hard objects, such as coins, knives, pins, and paperclips could damage your washing machine. Do not wash clothing with large buckles, buttons, or other heavy metal objects.

Metal on clothing may damage your clothing as well as the tub. Turn clothing with buttons and embroidered clothes inside out before washing them. If zips of pants and jackets are open while washing, the spin basket may be damaged. Zips should be closed and fixed with a string before washing.

Clothing with long strings may become entangled with other clothes damaging them. Be sure to fix the strings before starting the wash.

Prewashing cotton

Your new washing machine, combined with modern detergents, will give perfect washing results, thus saving energy, time, water and detergent. However, if your cotton is particularly dirty, prewash with a protein-based detergent.

Determining the load capacity

Do not overload the washing machine or your laundry may not wash properly. Use the chart below to determine the load capacity for the type of laundry you are washing.

Fabric Type	Load Capacity
Model	WF8750
Cotton - average/lightly soiled - heavily soiled	7.5 kg
Synthetics	3.0 kg
Sports Wear	2.5 kg
Delicates	2.5 kg
Wool	2.0 kg

- When the laundry is unbalanced (“UE” lights up on the display), redistribute the load. If the laundry is unbalanced, the spin efficiency may be degraded.
- When washing Bedding or Duvets, the wash time may be lengthened or the spin efficiency may be degraded.
- For Bedding or Duvets, the recommended load capacity is 1.8(kg) or less.

Make sure to insert brassieres (water washable) into a laundry net (to be purchased additionally).

- The metal parts of the brassieres may break through the material and damage the laundry. Therefore make sure to place them inside a fine laundry net.
- Small, light clothing such as socks, gloves, stockings and handkerchiefs may become caught around the door. Place them inside a fine laundry net.

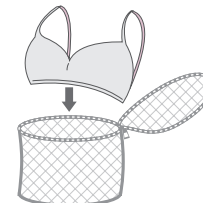

Do not wash the laundry net by itself without other laundry. This may cause abnormal vibrations that could move the washing machine and cause an accident resulting in injury.



washing a load of laundry

DETERGENT AND ADDITIVES INFORMATION

Which detergent to use

The type of detergent you should use is based on the type of fabric (cotton, synthetic, delicate items, wool), colour, wash temperature, and degree of soiling. Always use "low suds" laundry detergent, which is designed for automatic washing machines.

Follow the detergent manufacturer's recommendations based on the weight of the laundry, the degree of soiling, and the hardness of the water in your area. If you do not know how hard your water is, enquire at your local water authority.

To ensure maximum cleaning results, it is recommended that powdered detergent should be thoroughly dissolved in a small amount of water before adding to the machine.

- Do not use detergent that has hardened or solidified as the detergent may remain in the rinse cycle. It may cause your washing machine to not rinse properly or result in the overflow becoming blocked.

Detergent drawer

Your washing machine has separate compartments for dispensing detergent and fabric softener. Add all laundry additives to the correct compartment before starting your washing machine.

- Do NOT open the detergent drawer when your washing machine is running.

- Pull out the detergent drawer on the left side of the control panel.
- Add the recommended amount of laundry detergent directly into the detergent compartment ② before starting your washing machine.
- Add the recommended amount of fabric softener into the softener compartment ③ if required.
- When using the Prewash option, add the recommended amount of laundry detergent into the prewash compartment ①.

- When washing large items do NOT use the following detergent types.

- Tablet and capsule type detergents
- Detergents using a ball and net

- Concentrated or thick fabric softener and conditioner must be diluted with a little water before being poured into the dispenser (prevents the overflow from becoming blocked.)

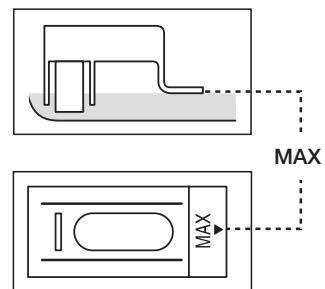
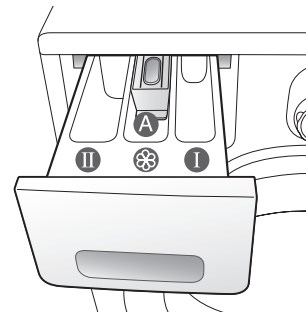

cleaning and maintaining your washing machine

Keeping your washing machine clean improves its performance, wards off unnecessary repairs, and lengthens its life.

DRAINING THE WASHING MACHINE IN AN EMERGENCY

1. Unplug the washing machine from the power supply.
2. Open the filter cover using a coin or a key.

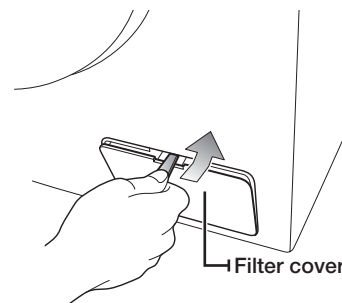

3. Unscrew the emergency drain cap by turning it to the left.

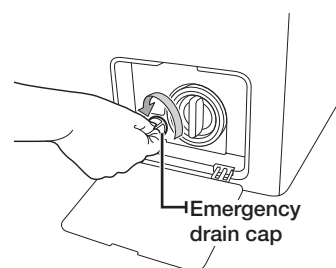

4. Hold the cap on the end of the emergency drain tube and slowly pull it out about 15 cm.
5. Allow all the water to flow into a bowl.
6. Reinsert the drain tube and screw the cap back on.
7. Replace the filter-cover.

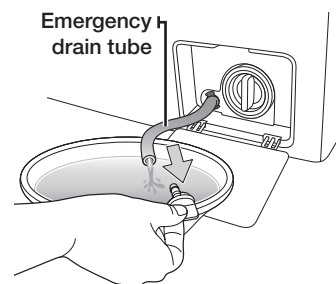

CLEANING THE EXTERIOR

1. Wipe the washing machine surfaces, including the control panel, with a soft cloth using a nonabrasive household detergent.
2. Use a soft cloth to dry the surfaces.
3. Do not pour water onto the washing machine.

cleaning and maintaining your washing machine

CLEANING THE DETERGENT DRAWER AND DRAWER RECESS

1. Press the release lever on the inside of the detergent drawer and pull the drawer out.
2. Remove the liquid detergent divider from the detergent drawer

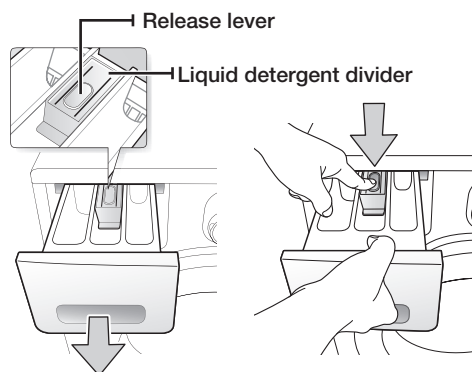

3. Wash all parts under running water.

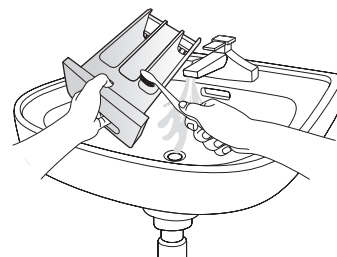

4. Clean the drawer recess with an old toothbrush.
5. Replace the liquid detergent divider by pushing it firmly into the drawer.
6. Push the drawer back into place.
7. To remove any remaining detergent, perform a rinse cycle without any laundry in the drum.

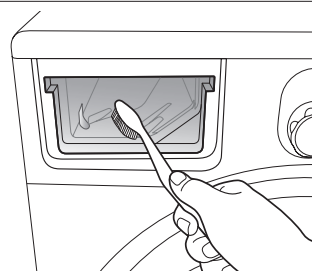



CLEANING THE DEBRIS FILTER

We recommend cleaning the debris filter 5 or 6 times a year, or when the error message of “5E” is displayed. (Refer to “Draining the washing machine in an emergency” in the previous page.)

1. Open the filter cover by using a key or coin.
2. Unscrew the emergency drain cap by turning it to the left and drain off all the water.
3. Unscrew the debris filter cap.

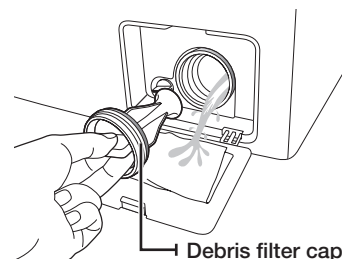

4. Wash any dirt or other material from the debris filter. Make sure the drain pump propeller behind the debris filter is not blocked.
5. Replace the debris filter cap.
6. Replace the filter cover.

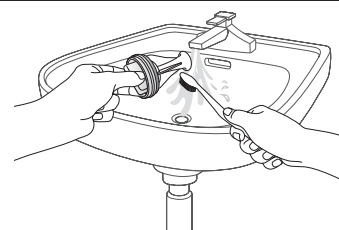

CLEANING THE WATER HOSE MESH FILTER

You should clean the water hose mesh filter at least once a year, or when the error message of “4E” is displayed:

1. Turn off the water supply to the washing machine.
2. Unscrew the hose from the back of the washing machine. To prevent water from gushing out due to the air pressure in the hose, cover the hose with a cloth.
3. Gently pull out the mesh filter from the end of the hose using a pair of pliers and rinse it under water until clean. Also clean inside and outside the threaded connector.
4. Push the filter back into place.
5. Screw the hose back onto the washing machine.
6. Make sure the connections are watertight and turn on the tap.



cleaning and maintaining your washing machine

REPAIRING A FROZEN WASHING MACHINE

If the temperature drops below freezing and your washing machine is frozen:

1. Unplug the washing machine.
2. Pour warm water over the tap to loosen the water supply hose.
3. Remove the water supply hose and soak it in warm water.
4. Pour warm water into the washing machine drum and let it sit for 10 minutes.
5. Reconnect the water supply hose to the water tap and check if the water supply and drain are operating normal.

STORING YOUR WASHING MACHINE

If you need to store your washing machine for an extended time, it's better to drain and disconnect it. Washing machines can be damaged if water is left in the hoses and internal components before storage.

1. Select the Quick 29' cycle and add bleach to the bleach compartment. Run your washing machine through the cycle without a load.
2. Turn the water taps off and disconnect the inlet hoses.
3. Unplug your washing machine from the electrical outlet, and leave your washing machine door open to allow air to circulate inside the tumbler.

 If your washing machine has been stored in below-freezing temperatures, allow time for any leftover water in your washing machine to thaw out before using it.



troubleshooting and information codes

CHECK THESE POINTS IF YOUR WASHING MACHINE...

PROBLEM	SOLUTION
Will not start	<ul style="list-style-type: none">• Make sure your washing machine is plugged in.• Make sure the door is firmly closed.• Make sure the water source tap(s) are turned on.• Make sure to press the Start/Pause button.
Has no water or not enough water	<ul style="list-style-type: none">• Turn the water tap on fully.• Make sure the water source hose is not frozen.• Straighten the water intake hoses.• Clean the filter on the water intake hose.
Has detergent remains in the detergent drawer after the wash cycle is complete	<ul style="list-style-type: none">• Make sure your washing machine is running with sufficient water pressure.• Make sure the detergent is added to the center of the detergent drawer.
Vibrates or is too noisy	<ul style="list-style-type: none">• Make sure your washing machine is on a level surface. If the surface is not level, adjust the washing machine feet to level the appliance.• Make sure that the shipping bolts are removed.• Make sure your washing machine is not touching any other object.• Make sure the laundry load is balanced.
The washing machine does not drain and/or spin	<ul style="list-style-type: none">• Straighten the drain hose. Eliminate kinked hoses.• Make sure the debris filter is not clogged.
Door is locked shut or will not open.	<ul style="list-style-type: none">• The door will not open until 3 minutes after the machine stops or the power turns off.

If the problem persists, contact your local Samsung Customer Service.



troubleshooting and information codes

INFORMATION CODES

When your washing machine malfunctions, you may see an information code on the display. If that happens, check this table and try the suggested solution before calling Customer Service.

CODE SYMBOL	SOLUTION
dE	<ul style="list-style-type: none">• Close the door.
4E	<ul style="list-style-type: none">• Make sure the source water tap is turned on.• Check the water pressure.
5E	<ul style="list-style-type: none">• Clean the debris filter.• Make sure the drainage hose is installed correctly.
UE	<ul style="list-style-type: none">• The laundry load is unbalanced. Redistribute the load. If only one item of clothing needs washing, such as a bathrobe or pair of jeans, the final spin result might be unsatisfactory and an "UE" error message will be shown in the display window.
cE/3E	<ul style="list-style-type: none">• Call the after-sales service.

For any codes not listed above, or if the suggested solution doesn't fix the problem, call your Samsung Service Centre or local Samsung dealer.

cycle chart

CYCLE CHART

(● user option)

PROGRAM	Max load(kg)	DETERGENT			Max Temp (°C)
	WF8750	Pre-wash	wash	Softener	
Cotton	7.5	●	yes	●	95
Synthetics	3.0	●	yes	●	60
Sports Wear	2.5	●	yes	●	60
Delicates	2.5	-	yes	-	40
Wool	2.0	-	yes	-	40
Handwash	2.0	-	yes	●	40
Water Saving	7.5	●	yes	●	60
Daily Wash	3.0	●	yes	●	60
Quick 29'	3.0	-	yes	●	60

PROGRAM	Spin Speed(MAX) rpm	Delay End	Cycle time (min)
	WF8750		
Cotton	1000	●	120
Synthetics	1000	●	84
Sports Wear	1000	●	65
Delicates	800	●	45
Wool	800	●	37
Handwash	400	●	30
Water Saving	1000	●	131
Daily Wash	1000	●	65
Quick 29'	1000	●	29





























1. A cycle with a prewash takes approx. 15 minutes longer.
2. The cycle duration data has been measured under the conditions specified in Standard IEC 60456 / EN 60456.
3. Consumption in individual homes may differ from the values given in the table due to variations in the pressure and temperature of the water supply, the load and the type of laundry.
4. When the Intensive Wash function is selected, the cycle time is increased for each cycle.

appendix

FABRIC CARE CHART

The following symbols provide garment care directions. The care labels include four symbols in this order: washing, bleaching, drying and ironing, and dry cleaning when necessary.

The use of symbols ensures consistency among garment manufacturers of domestic and imported items. Follow the care label directions to maximize garment life and reduce laundering problems.

 Resistant material	 Can be ironed at 100 °C max
 Delicate fabric	 Do not iron
  Item may be washed at 95 °C	 Can be dry cleaned using any solvent
  Item may be washed at 60 °C	 Dry clean with perchloride, lighter fuel, pure alcohol or R113 only
  Item may be washed at 40 °C	 Dry clean with aviation fuel, pure alcohol or R113 only
  Item may be washed at 30 °C	 Do not dry clean
 Item may be hand washed	 Dry flat
 Dry clean only	 Can be hung to dry
 Can be bleached in cold water	 Dry on clothes hanger
 Do not bleach	 Tumble dry, normal heat
 Can be ironed at 200 °C max	 Tumble dry, reduced heat
 Can be ironed at 150 °C max	 Do not tumble dry

PROTECTING THE ENVIRONMENT

- This appliance is manufactured from recyclable materials. If you decide to dispose of this appliance, please observe local waste disposal regulations. Cut off the power cord so that the appliance cannot be connected to a power source. Remove the door so that animals and small children cannot get trapped inside the appliance.
- Do not exceed the detergent quantities recommended in the detergent manufacturers' instructions.
- Use stain removal products and bleaches before the wash cycle only when strictly necessary.
- Save water and electricity by only washing full loads (the exact amount depends upon the program used).

DECLARATION OF CONFORMITY

This appliance complies with European safety standards, EC directive 93/68 and EN Standard 60335.

SPECIFICATIONS

TYPE		FRONT LOADING WASHING MACHINE		
DIMENSIONS		WF8750LS		
		W598mm X D600mm X H844mm		
WATER PRESSURE		50 kPa ~ 800 kPa		
WATER VOLUME		56 ℓ		
NET WEIGHT		65 kg		
WASH AND SPIN CAPACITY		7.5 kg		
POWER CONSUMPTION	WASHING		220 V	150 W
			240 V	150 W
	WASH AND HEATING		220 V	2000 W
			240 V	2400 W
	SPIN	230V	500 W	
PUMPING		34 W		
PACKAGE WEIGHT	PAPER		2.5 kg	
	PLASTIC		1.5 kg	
SPIN REVOLUTIONS		rpm		1000

The appearance and specifications of the product are subject to change without prior notice for purposes of product enhancement.



memo



appliancesonline
.CO

Australia's largest online appliance retailer





memo



appliancesonline
.CO

Australia's largest online appliance retailer





QUESTIONS OR COMMENTS?

Country	CALL	OR VISIT US ONLINE AT
AUSTRALIA	1300 362 603	www.samsung.com/au



Code No. DC68-02591X_EN
Australia's largest online appliance retailer

