

USER MANUAL

Dishwasher

WSF6608



Westinghouse

CONGRATULATIONS

Congratulations and thank you for choosing our product. We are sure you will find your new appliance a pleasure to use and a great asset to your cooking. Before you use the appliance, we recommend you read through the whole user manual which provides a description of the product and its functions.

To avoid the risks that are always present when you use an appliance, it is important that the appliance is installed correctly and that you read the safety instructions carefully to avoid misuse and hazards. We recommend that you keep this instruction booklet for future reference and pass it on to any future owners. This appliance complies with the requirements of Australian Standard AS/NZ 60335.2.6. Gas appliances also comply with the requirements of AS4551.

CONDITIONS OF USE

This appliance is intended to be used in household and similar applications such as:

- Staff kitchen areas in shops, offices and other working environments
- Farm houses
- By clients in hotels, motels and other residential type environments
- Bed and breakfast type environments.

Record model and serial number here:

Model:.....

Serial number:.....



ENVIRONMENTAL TIPS

IMPORTANT – CHECK FOR ANY DAMAGE OR MARKS

If you find the dishwasher is damaged or marked, you must report it within 7 days if you wish to claim for damage/ marks under the manufacturers warranty. This does not affect your statutory rights.

CONTENTS

Important safety instructions	3
Recycling	3
Safety information	3
Recommendations	4
Items not suitable for dishwashing	4
Technical specifications	5
Conformity with the standards and Test data	5
Description of your appliance	6
Quick Start Guide	8
Installing the machine	9
Positioning the machine	9
Water connections	9
Water inlet hose	9
Water outlet hose	9
Electrical connection	10
Fitting the machine undercounter	11
Preparing the machine for use	12
Prior to using the machine	12
Detergent usage	12
Filling the detergent compartment	12
Combined detergent	13
Filling with rinse aid and making the setting	13
Loading your dishwasher	14
Alternative basket loads	17
Standard loading and Test data	18
Program descriptions	19
Program items	19
Switching on the machine and selecting a program	20
Switching on the machine	20
Program follow-up	20
Changing a program	20
Changing a program with resetting	21
Switching the machine off	21
Maintenance and Cleaning	22
Filters	22
Spray arms	23
Hose filter	23
Failure codes and what to do in case of failure	24
Practical and useful information	24
Troubleshooting	25
Notes	26
Warranty	27



ENVIRONMENTAL TIPS

INFORMATION ON DISPOSAL FOR USERS

- Most of the packaging materials are recyclable. Please dispose of those materials through your local recycling depot or by placing them in appropriate collection containers.
- If you wish to discard this product, please contact your local authorities and ask for the correct method of disposal.

IMPORTANT SAFETY INSTRUCTIONS

These warnings have been provided in the interest of safety. You **MUST** read them carefully before installing or using the appliance.
The symbols you will see in this booklet have these meanings:



WARNING

This symbol indicates information concerning your personal safety



TIPS AND INFORMATION

This symbol indicates tips and information about use of the appliance



ENVIRONMENTAL TIPS

This symbol indicates tips and information about economical and ecological use of the appliance

RECYCLING

- Certain components and the packaging of your machine have been produced from recyclable materials.
- Plastic parts are marked with international abbreviations: (>PE< , >PS< , >POM<, >PP<, ...)
- Cardboard parts have been produced from recycled paper and they should be disposed of into waste paper collection containers for recycling.
- Such materials are not suitable for being disposed of into garbage bins. They should be delivered to recycling centres instead.
- Contact relevant centres in order to obtain information on methods and points of disposal.

SAFETY INFORMATION

When you take delivery of your machine

- Check for any damage to your machine or to its packaging. Never start a machine damaged in any way, make sure to contact an authorised technician.
- Unwrap the packaging materials as indicated and dispose of them in accordance with the rules.

The points to pay attention during machine installation

- Choose a suitable, safe and level place to install your machine.
- Carry out the installation and connection of your machine by following the instructions.
- This machine should be installed and repaired by an authorised technician only.
- Only original spare parts should be used with the machine.
- Before installing, be sure that the machine is unplugged.
- Check whether the indoor electrical fuse system is connected according to the regulations.

- Pay special attention and be sure that the machine does not stand on the electricity supply cable.
- Never use an extension cord or a multiple socket for making a connection. The plug should be easily accessible after the machine has been installed.
- After installing the machine to a suitable place, run it unloaded for the first time.

IN DAILY USE

- Do not get up, sit or place a load on the open door of the dishwasher, it may fall over.
- Never put into the detergent and rinse aid dispensers of your machine anything other than those detergents and rinse aids which are produced specifically for dishwashers. Our company will not be responsible for any damage that might occur in your machine otherwise.



WARNING

The water in the machine's washing section is not drinking water, do not drink it.

- Due to danger of explosion, do not put into the machine's washing section any chemical agents such as solvents.
- Check whether plastic items are heat-resistant before washing them in the machine.
- Do not put into your machine those items which are not suitable for dishwashing. Also, do not overload basket.
- The machine door should not be opened while the machine is in operation, to avoid the risk of hot water spraying out. A safety device ensures that the machine stops if the door is opened.



WARNING

Do not leave your dishwasher's door open, this may lead to accidents and injury.



WARNING

Place knives and other sharp ended objects in the cutlery basket in the point down position.

- This appliance is not intended for use by persons (including children) with reduced physical, sensory or mental capabilities, or lack of experience and knowledge, unless they have been given supervision or instruction concerning use of the appliance by a person responsible for their safety.

SAFETY INFORMATION AND RECOMMENDATIONS

FOR YOUR CHILDREN'S SAFETY

- After removing the machine's packaging, make sure that the packaging material is out of reach of children.
- Do not allow children to play with or start the machine.
- Keep your children away from detergents and rinse aids.
- Keep children away from the machine while it is open because there may still be residues of cleaning substances inside the machine.
- Be sure that your old machine does not pose any threat to children. Remove the dishwasher door lock and power supply cord.

IN CASE OF MALFUNCTIONING

- Any malfunction in the machine should be repaired by qualified persons. Any repair work performed by anyone other than the authorised service personnel will cause your machine to be left outside the scope of warranty.
- Prior to any repair work on the machine, be sure to unplug the dishwasher from the power supply. Do not pull by the cable when unplugging. Make sure to turn off the water tap.

RECOMMENDATIONS

- For energy and water saving, remove coarse residues on your dishes before placing the dishes into the machine. Start your machine after having fully loaded it.
- Use the pre-wash program only whenever necessary.
- Place items such as bowls, glasses and pots into the machine so they will face down.

Items not suitable for dishwashing:

- Cigarette ashes, candle leftovers, polish, paint, chemical substances, iron-alloy materials;
- Forks, spoons and knives with wooden or bone, ivory or nacre-coated handles; glued items, items soiled with abrasive, acidic or base chemicals;
- Plastic items that are not heat-resistant, copper or tin coated containers;
- Aluminium and silver objects (they may discolour, become dull);
- Certain delicate glass types, porcelains with ornamental printed patterns (may fade even after the first wash); certain crystal items (may lose their transparency over time), laminated cutlery that is not heat-resistant, lead crystal glasses, cutting boards, items manufactured with synthetic fibre;
- Absorbent items such as sponges or kitchen rags are not suitable for dishwashing.



WARNING

Some dishwasher detergents are strongly alkaline. They can be extremely dangerous if swallowed. Avoid contact with the skin and eyes and keep children away from the dishwasher when the door is open. Check that the detergent compartment is empty after completion of wash cycle.

DESCRIPTION OF YOUR APPLIANCE

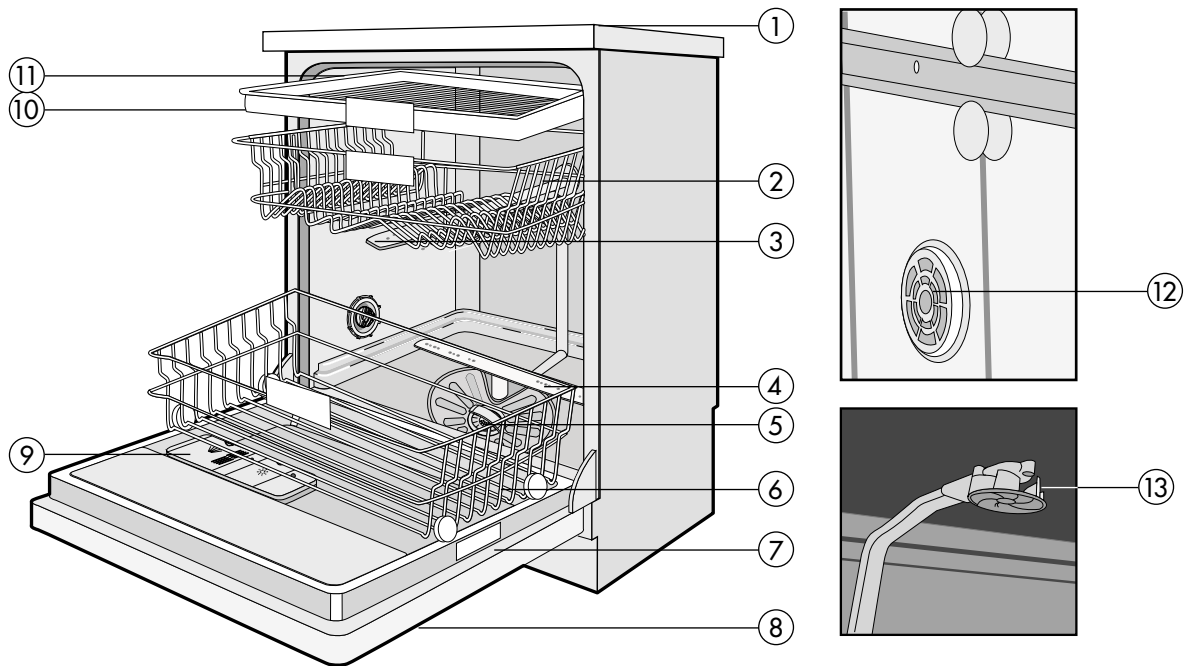

- | | |
|----------------------------|--|
| 1. Worktop | 9. Detergent and rinse-aid dispenser |
| 2. Upper basket with racks | 10. Upper basket track latch |
| 3. Upper spray arm | 11. Upper cutlery basket |
| 4. Lower spray arm | 12. Turbo drying unit: This system provides better drying performance for your dishes. |
| 5. Filters | 13. Ceiling spray impeller: It provides better washing for the dishes at upper basket. |
| 6. Lower basket | |
| 7. Rating plate | |
| 8. Control panel | |

TECHNICAL SPECIFICATIONS

Capacity	15 place settings
Height	845 mm
Height (without worktop)	815 mm
Width	596 mm
Depth	598 mm
Net Weight	56 kg
Electricity input	220-240 V, 50 Hz
Total Power	2200 W
Heating Power	2000 W
Pump Power	100W
Drain Pump Power	30 W
Water supply pressure	0.03 MPa (0,3 bar) - 1 MPa (10 bar)
Current	10 A

- Electrolux reserves the right to amend design and technical specifications.

DESCRIPTION OF YOUR APPLIANCE

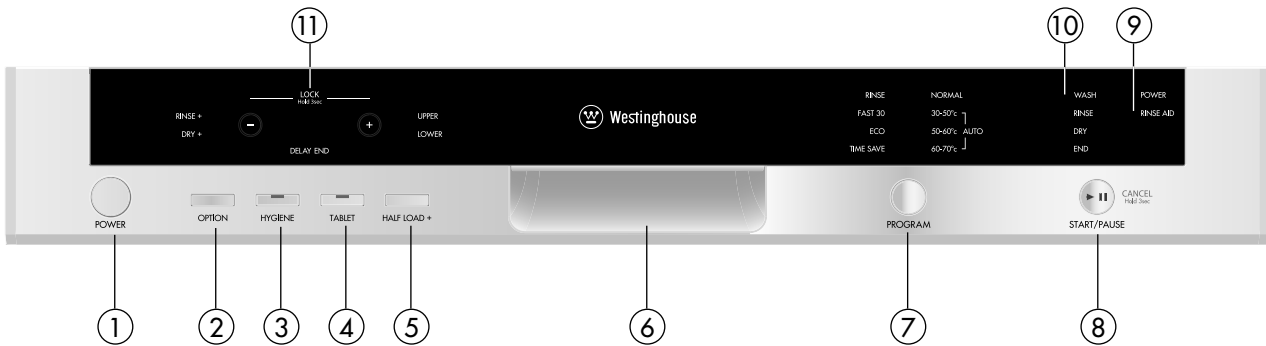

1. POWER BUTTON

When pressed on, the machine is energised and the power light illuminates.

2. OPTION BUTTON RINSE+ / DRY+

You can add extra rinsing or drying functions into the selected program by using this button.

Once you select extra rinsing function, the light for extra rinsing on the left upper-hand side of the indicator will come on, and thus washing-rinsing steps will be added into the selected program, so you can ensure that your dishes will be extracted cleaner and glossier.

Once you select extra drying function, the light for extra drying on the left lower-hand side of the indicator will come on, and thus the extra heating and drying steps will be added into the selected program, so you can ensure that your dishes will be extracted dryer.

3. HYGIENE BUTTON

By using this option, washing temperature and periods during respective cycles may be changed, which ensures more hygienic washing.

4. TABLET BUTTON

Use this option when using combined detergent that contains rinse aid and extra functions.

5. HALF LOAD + BUTTON

Using the function 1/2, three sorts of washing up can be done, those being lower basket, upper basket and both baskets.

 If you have little amount of dishes in your machine and if you have to wash them, you can also activate the semi-filling function in some of the programs additionally. If you have dishes in both baskets, press the key 1/2 and select the position in which both lamps are highlighted.

 If you have dishes only in the upper basket, press the key 1/2 and select the position in which the upper lamp is illuminated. Thus, washing up shall be done only on the upper basket of your machine.

No dishes should certainly be available in the lower basket while using this feature.

 If you have dishes only in the lower basket, press the key 1/2 and select the position in which the lower lamp is illuminated.

Thus, washing up shall be done only on the lower basket of your machine. In using this feature, make sure that there are no dishes in the upper basket. Note: If you have used an extra feature on the latest washing program, this feature will remain active also on the next washing program. If you do not want to use this feature on the newly selected washing program, press the selected feature button again, and check that the lamp on the button goes off.

6. DOOR HANDLE

The door handle is used to open/close the door of your machine.

7. PROGRAM SELECTOR BUTTON

With the program selector button, you can select a suitable program for your dishes.

8. START/PAUSE BUTTON

The Start/Pause button will start the selected program. In the Pause condition while wash LED is on, Start/Pause LED will blink.

9. RINSE AID / POWER INDICATORS

When the rinse aid light illuminates, fill in rinse aid chamber.

The power light indicates power is available to the appliance.

NOTE: If you have used an extra option on the last washing program, this feature will remain active also on the next washing program. To deselect an option on the newly selected washing program, press the selected option

button again, and check that the indicator lamp on the button goes off.

10. PROGRESS INDICATOR LIGHTS

Program status can be monitored via the progress indicator lights on control panel:

- Wash
- Rinse
- Dry
- End

11. TIME INDICATOR DISPLAY

Time Indicator displays the program times and remaining time for the program in operation. In addition, you can adjust program delay time by pressing the buttons on the indicator before program starts. If you want to change delay time, you can set the time by pressing Start/Pause button and using buttons on the indicator. Press Start/Pause button again in order to activate.

CHILD LOCK OPERATION

In order to activate child lock, press "+" and "-" buttons simultaneously for 3 seconds. At this time, "CL" appears for 2 seconds on remaining time indicator. To deactivate child lock, press "+" and "-" buttons again simultaneously for 3 seconds. "CL" will blink once.

QUICK START GUIDE

SWITCHING ON THE MACHINE



PROGRAM FOLLOW-UP

You can follow the program flow using the program follow-up lamps located on the control panel.



CHANGING A PROGRAM

If you would like to change programs while a washing program is continuing.

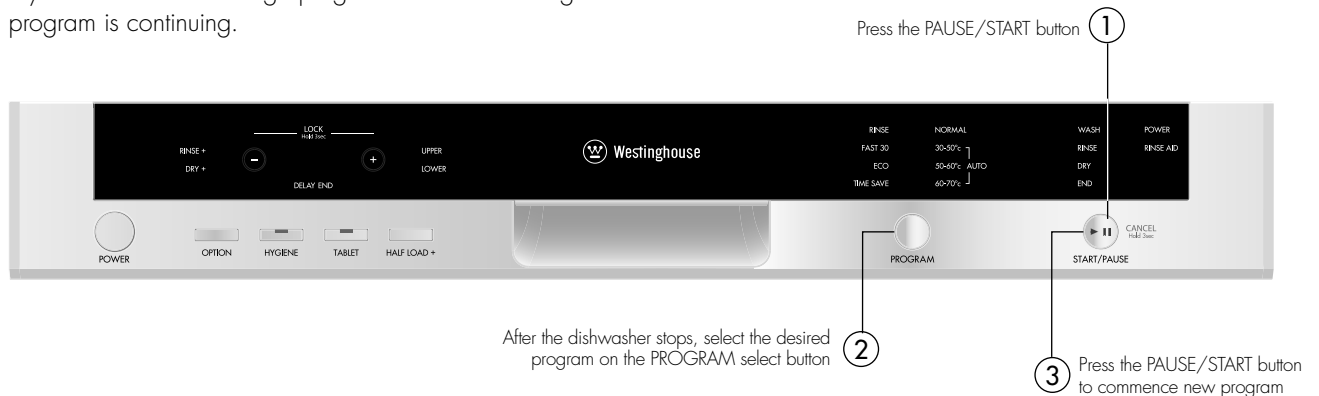

CANCELLING A PROGRAM

If you want to cancel current program for any reason.

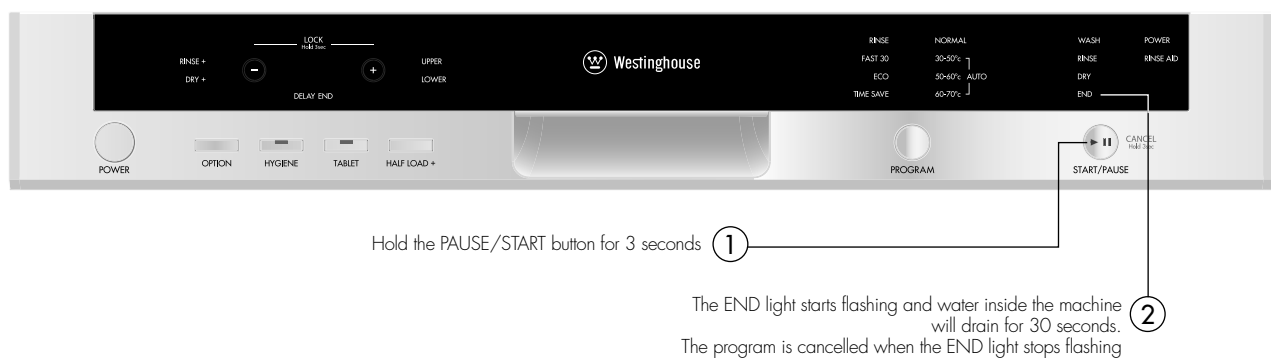

INSTALLING THE MACHINE

POSITIONING THE MACHINE

When considering the location for the dishwasher, ensure that there is adequate space to enable loading and unloading of the dishes.

- Do not put your machine in any location where the ambient temperature can fall below 5°C.
- Before positioning, take the machine out of its packaging by following the warnings located on the package.
- Position the machine close to a water tap and drain. You need to site your machine, taking into consideration that its connections will not be altered once they are made.
- Do not grip the machine by its door or panel in order to move it.
- Take care to leave a certain clearance from all sides of the machine so that you can comfortably move it back and forth during cleaning.
- Make sure that the water inlet and outlet hoses do not get squeezed while positioning the machine. Also, make sure that the machine does not stand on the electrical cable. Adjust the machine's adjustable feet so that it can stand level and balanced. Proper positioning of the machine ensures problem-free opening and closing of its door.
- If the door of your machine does not close properly, check if the machine is stable on the floor it stands on; if not, adjust the adjustable feet and ensure its stable position.

WATER CONNECTION

Be sure that the indoor plumbing is suitable for installing a dishwasher. Also, we recommend that you fit a filter at the entrance of your place or apartment so as to avoid any damage to your machine because of any contamination (sand, clay, rust etc) that might be occasionally carried in through the main's water supply or the indoor plumbing, and to forestall such complaints as yellowing and formation of deposits after washing.

WATER INLET HOSE

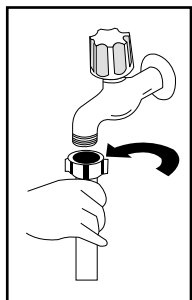

Do not use the water inlet hose of your old machine, you must use the new water inlet hose supplied with your machine instead. Before connecting the water inlet hose to the water tap, ensure clean water is flowing from the tap before making the connection. Connect the water inlet hose directly to the water inlet tap. The pressure supplied by the tap

should be at a minimum of 0.03 MPa and at a maximum of 1 MPa. If the water pressure is above 1 MPa, a pressure-relief valve should be fitted in between.

After the connections are made, the tap should be turned on fully and checked for water tightness. For the safety of your machine, make sure to always turn off the water inlet tap after each wash program is finished.

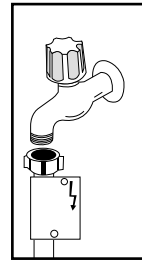

WARNING

NOTE: Aquastop inlet hose has components using 240V. Do not cut Aquastop inlet hose. Do not let it get folded or twisted.

WATER DRAIN HOSE

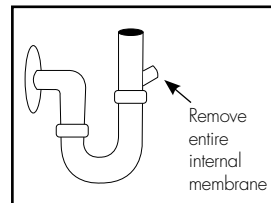

If you connect the water drain hose to a trap spigot under the sink, remove the plastic membrane. If you do not remove the entire membrane, remaining food can cause blockage in the drain hose spigot. Ensure a hose clamp is used to secure the hose to the spigot.

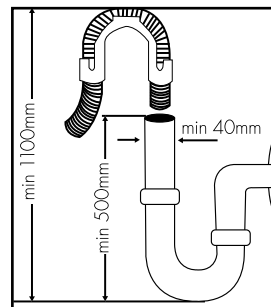

The water drain hose can be connected either directly to the water drain hole or to the sink outlet spigot. Using a hose hook (if available), the water can be drained directly into the sink by positioning the hose hook over the edge of the sink.

This connection should be at a minimum of 50 cm and at a maximum of 110 cm above the base of the dishwasher.

WARNING: Maximum drain hose length is 4m. Longer hose length will prevent correct draining and result in poor wash performance.

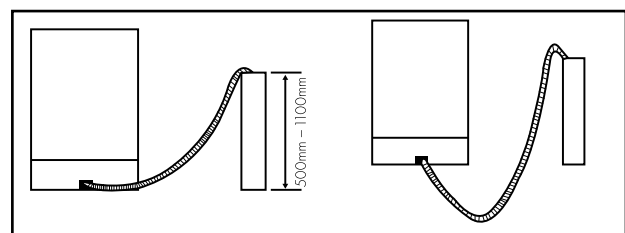

✓
(correct)

✗
(incorrect)

INSTALLING THE MACHINE

WARNING **ELECTRICAL CONNECTION**

The earthed plug of your machine should be connected to an earthed outlet supplied by suitable voltage and current. If there is no earthing installation, have a competent electrician carry out an earthing installation. In case of usage without earthing installed, our company will not be responsible for any loss of usage that might occur.

The indoor fuse current value should be 10-16 A.

Your machine is designed for 220-240 V. The machine should not be plugged in during installation.

- Always use the molded plug supplied with your machine.
- Running in low voltage will cause a decline in washing quality.
- The machine's electrical cable should be replaced by an authorised service or an authorised electrician only. Failure to do so may lead to accidents.
- For safety purposes, always make sure to disconnect the plug when a wash program is finished.
- In order not to cause an electric shock, do not unplug when your hands are wet.
- When disconnecting your machine from the mains supply, always pull from the plug. Never pull the cord itself.

FITTING THE MACHINE UNDERCOUNTER

If you wish to fit your machine undercounter, check whether you have sufficient space under your countertop and whether the wiring-plumbing is suitable to do so.

1. If you decide that the space under the countertop is suitable for fitting your machine, remove the worktop as shown in the illustration.
2. To remove the worktop, remove the screws that hold the worktop which are located at the rear of the machine; then push the front panel 1 cm from the front towards the rear and lift it.

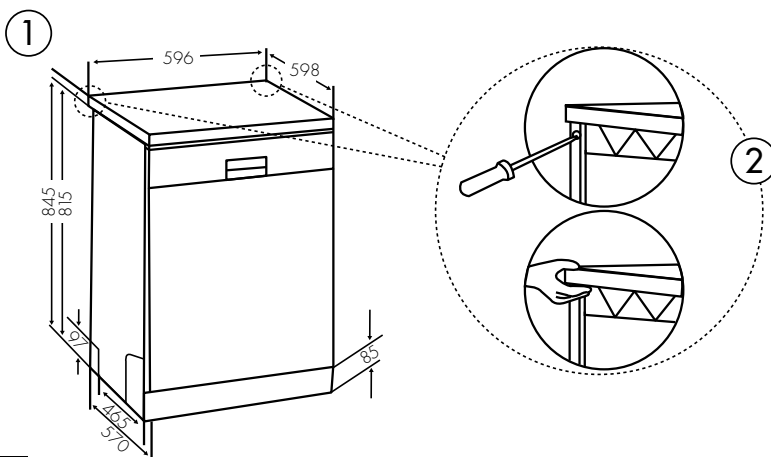

INSTALLING THE MACHINE

3. Adjust the machine feet according to the slope of the floor.
4. Fit your machine by pushing it undercounter without letting the hoses get crushed or bent.



WARNING

After removal of worktop, ensure the opening for the dishwasher is according to the following dimensions.

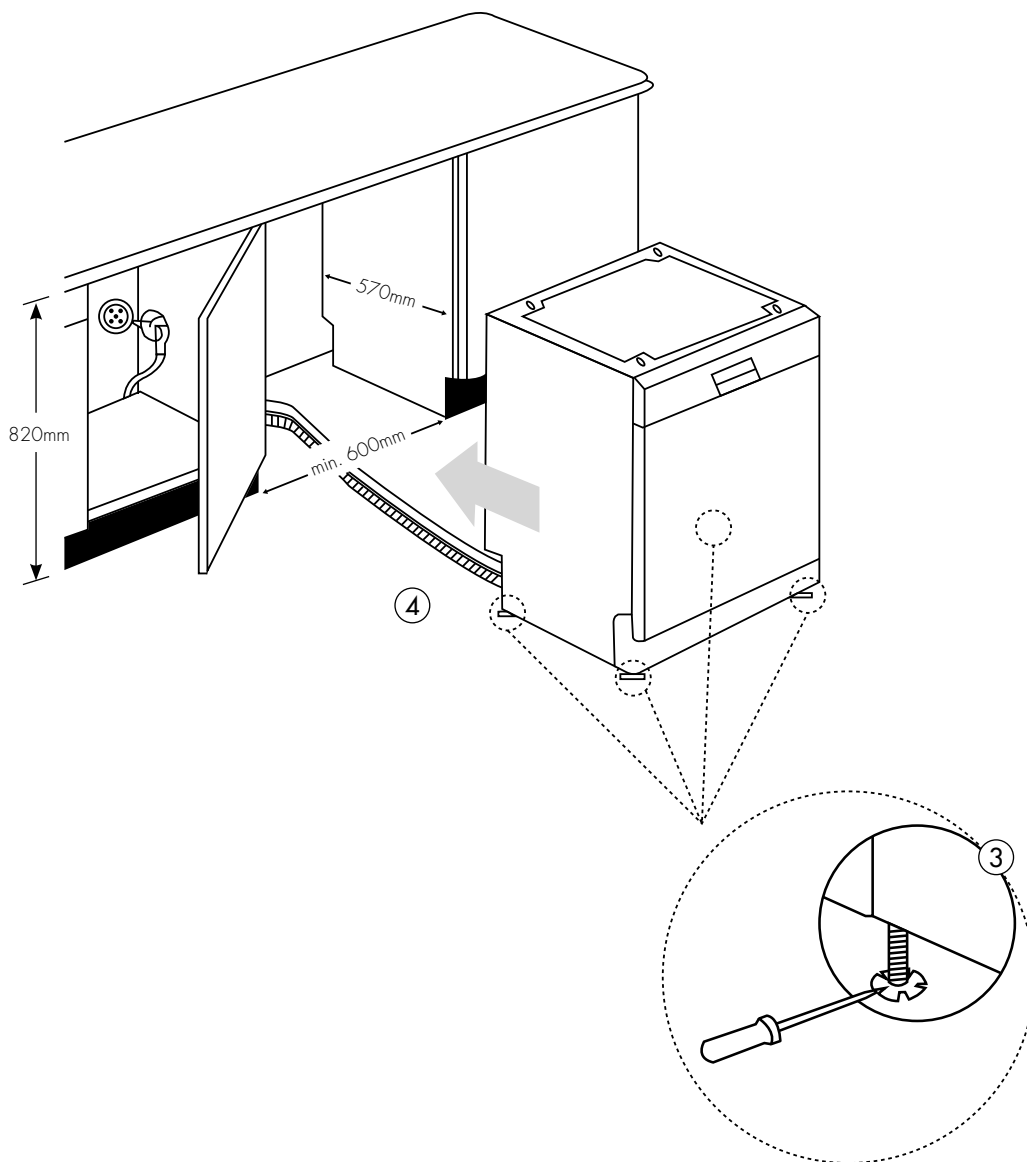

PREPARING THE MACHINE FOR USE

PRIOR TO USING THE MACHINE FOR THE FIRST TIME

- Check whether the electricity and water supply specifications match the values indicated by the installation instructions for the machine.
- Remove all packaging materials inside the machine.
- Fill the rinse aid compartment.

DETERGENT USAGE

Use a detergent specifically designed for use in domestic dishwashers. You can find powder, gel, and tablet detergents in the market that have been designed for household dishwashers. Detergent should be put into the compartment prior to starting the machine. Keep your detergents in cool, dry places out of reach of your children. Do not fill detergent into the detergent compartment more than required; otherwise it may etch your glasses as well as leaving undissolved detergent in the dishwasher. Should you need more information concerning the detergent you will use, contact detergent manufacturers directly.

FILLING THE DETERGENT COMPARTMENT

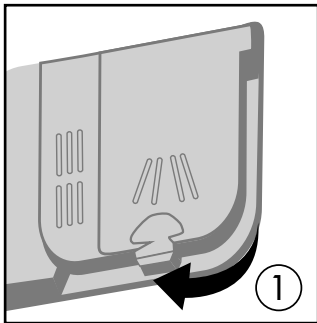

1. Push the latch to open the detergent container as shown in image 1.

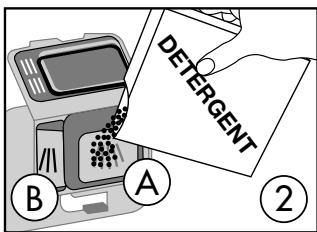

2. Detergent compartment has level lines inside. It is possible to measure the right detergent amount using these lines. Detergent compartment (A) can take 40 gm of detergent. Open the dishwasher detergent and pour into the larger compartment 25 gm if your dishes are heavily soiled or 15 gm if they are less soiled.

If your dishes have been kept dirty for a very long time, if there are dried food wastes on them, and if you have fully loaded the dishwasher, pour 5 gm detergent into the pre-wash compartment (B) and start your machine.

You may have to add more detergent into your machine, depending on the degree of soil and on the water hardness level in your area.

COMBINED DETERGENT

Detergent manufacturers also produce combined detergents called "2 in 1", "3 in 1" or "5 in 1" etc.

"2 in 1" detergents contain detergent or rinse aid. When using "2 in 1" detergent make sure to check the specifications of the tablet.

Other tablet detergents contain detergent + rinse aid + various extra functions/additives.

Generally, combined detergents produce acceptable results under certain usage conditions only. Such detergents contain rinse aid in preset amounts.

Points to consider when using these type of products:

- Always make sure to check the specifications of the detergent you will use or whether or not it is a combined detergent.
- Check if the detergent used is appropriate for the hardness of mains water.
- Observe the instructions on packaging when using such products.
- If detergents are in the form of tablets, never put them into the interior section or the cutlery basket of the dishwasher. Always put the tablets into the detergent compartment in the detergent dispenser.
- Tablets produce good results for certain types of usage only. If you are using this type of detergent, you need to contact the manufacturer and find out about the suitable conditions of use.
- When the conditions of use of such products and the machine settings are appropriate, they ensure savings in rinse aid consumption.
- Contact the detergent manufacturers if you are not obtaining good wash results (if your dishes have limescale and stay wet) after having used 2 in 1 or 3 in 1 detergents. The scope of warranty for your machine does not cover any complaints caused by the use of these types of detergents.

Recommended usage: If you want to obtain better results while using combined detergents, add rinse aid into your machine and adjust the water softener setting and the rinse aid setting to the lowest position.

Solubility of the tablet detergents produced by different companies can vary depending on the temperature and time. Therefore, it is not recommended to use these detergents in short programs. It is more suitable to use powder detergents in short programs.



WARNING

Should any problem, which you have not encountered before, occur with the use of these type of detergents, contact the detergent manufacturers directly.

PREPARING THE MACHINE FOR USE

WHEN YOU STOP USING COMBINED DETERGENTS

- Fill the rinse aid compartments.
- Select a suitable rinse aid setting.

FILLING WITH RINSE AID AND MAKING THE SETTING

Rinse aid is used to improve the drying of the wash load and reduce the deposit of cloudy drops and streaks on glasses and dishware. For this reason, care should be taken that there is adequate amount of rinse aid in the rinse aid compartment and only rinse aid produced for use in dishwashers should be used.

If the rinse aid lamp on the control panel illuminates, fill the rinse aid compartment with rinse aid.

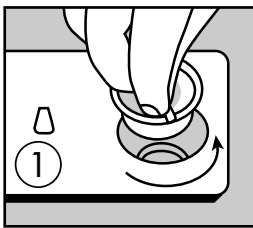

1. To put in rinse aid, remove the rinse aid compartment cap by turning it.
2. Fill the rinse aid compartment with rinse aid until the rinse aid level indicator becomes dark; refit the cap by locating the locking pins and close it by turning in the opposite direction. By checking the rinse aid level indicator on the detergent dispenser, you can understand whether or not your machine needs rinse aid. A dark indicator means that there is rinse aid in the compartment, while a light indicator shows that you need to fill the compartment with rinse aid.

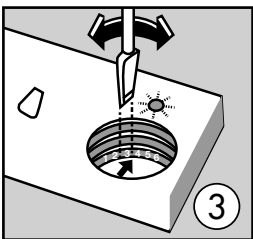
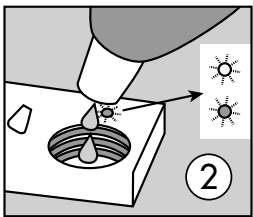

3. The rinse aid level adjuster can be set to a position between 1 and 6. Factory setting for rinse aid is position 3. You need to increase the setting of the adjuster if water stains form on your dishes after a wash, whereas you need to decrease the setting if a blue stain is left when wiped by hand. (3)



TIPS AND INFORMATION

ONLY USE RINSE AID SUITABLE FOR AUTOMATIC DISHWASHERS. As rinse aid residues left as a result of overflowing will create extremely high amounts of foam and reduce the washing performance, remove the excess amount of rinse aid by wiping it with a rag. Remove all excess rinse aid if spilt while filling.

LOADING YOUR DISHWASHER

Correctly loaded dishes will result in the best energy consumption, washing and drying performance. There are two separate baskets for you to load your dishes into your machine. You can load into the lower basket round and deep items as pots with long handles, pot lids, plates, salad plates and cutlery sets.

The upper basket has been designed for tea plates, dessert plates, salad bowls, cups and glasses. When placing long-stem glasses and goblets, lean them against the basket edge, rack or glass support wire and not against other items. Do not lean long glasses against one another if they are unsupported, they may break. It is more appropriate to locate the thin narrow parts into the middle sections of baskets. You can place spoons among the other cutlery sets in order to prevent them from sticking to one another. You are recommended to use the cutlery grid in order to obtain the best result. To avoid any possible injuries, always place such long-handle and sharp-pointed items such as serving forks, bread knives etc. with their sharp points facing down or horizontally on the baskets.

TIPS AND INFORMATION

Ensure the position of the dishware does not prevent the upper or lower spray arm from turning.

TOP BASKET CUP RACK

These racks are designed to increase the capacity of the top basket. You can place your glasses and cups on the racks. You can adjust the height of these racks. Thanks to this feature, you can place different sizes of glasses under these racks. The cup racks can be adjusted to 3 height positions. In addition, you can place long forks, knives and spoons on these racks laterally, so that they do not block the revolution of the spray arm.

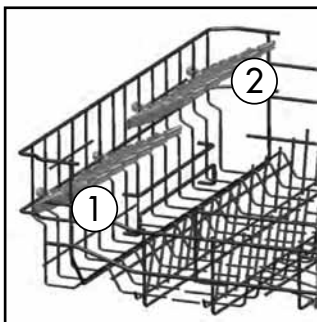

TOP BASKET FOLDING SUPPORTS

Foldable racks on the upper basket are designed in order to let you place big items easier such as pots, pans, etc. If requested, each part can be folded separately, or all of them can be folded and larger spaces can be obtained. You can use foldable racks by raising them upwards, or by folding down.

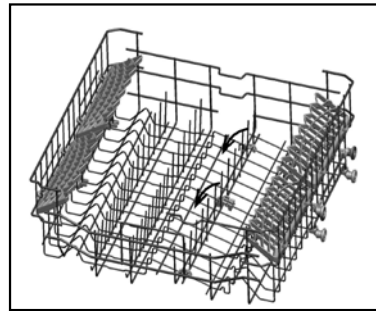

TOP BASKET HEIGHT ADJUSTMENT WHILE IT IS FULL

Basket height adjustment mechanism on the top basket of your machine is designed to let you adjust the height of your top basket (refer to diagram ①) upwards or (refer to diagram ②) downwards, without removing it from your machine when it is full, and create large spaces at the top or bottom area of your machine as needed. Basket of your machine is set to upper position in factory settings.

In order to raise your basket, hold it from both sides and pull it upwards. In order to lower it, hold it from both sides again, pull upwards and lower carefully.

Make sure that both sides are in the same position (up or down).

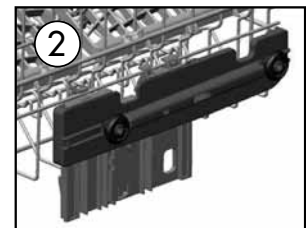
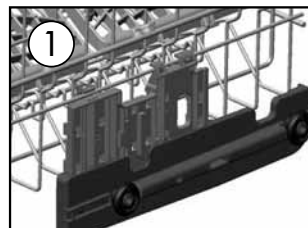
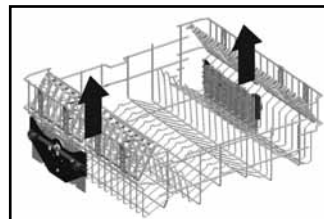

LOADING YOUR DISHWASHER

UPPER CUTLERY BASKET

The upper cutlery basket is designed for you to place forks, spoons and knives, long dippers and small items.

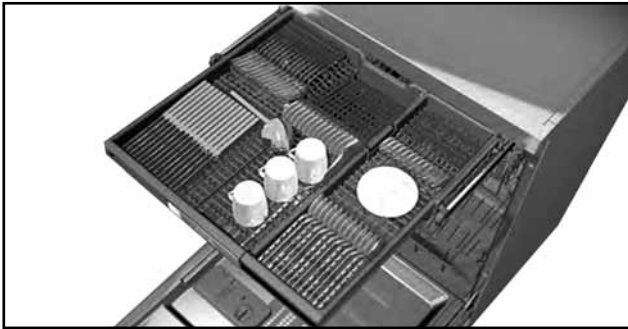

Because it can easily be taken out of the machine, it allows your dishes to be taken out of the machine along with the basket after washing.

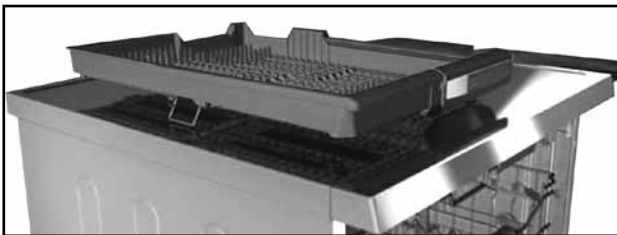

The upper cutlery basket is composed of two pieces. If you need to make space for the dishes in the upper basket, you can take out the left or right part of the upper cutlery basket in order to obtain more space.

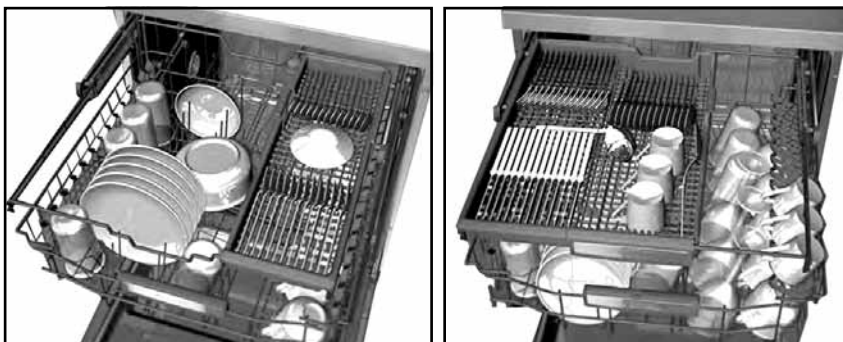

WARNING

Knives and other sharp objects must be placed horizontally in the cutlery basket.

LOADING YOUR DISHWASHER

LOWER BASKET FOLDING RACKS

Folding racks consisting of four parts that are located on the lower basket of your machine are designed in order to let you place big items easier such as pots, pans, etc. If required, each part can be folded separately, or all of them can be folded and larger spaces can be obtained. You can use folding racks by raising them upwards, or by folding down.

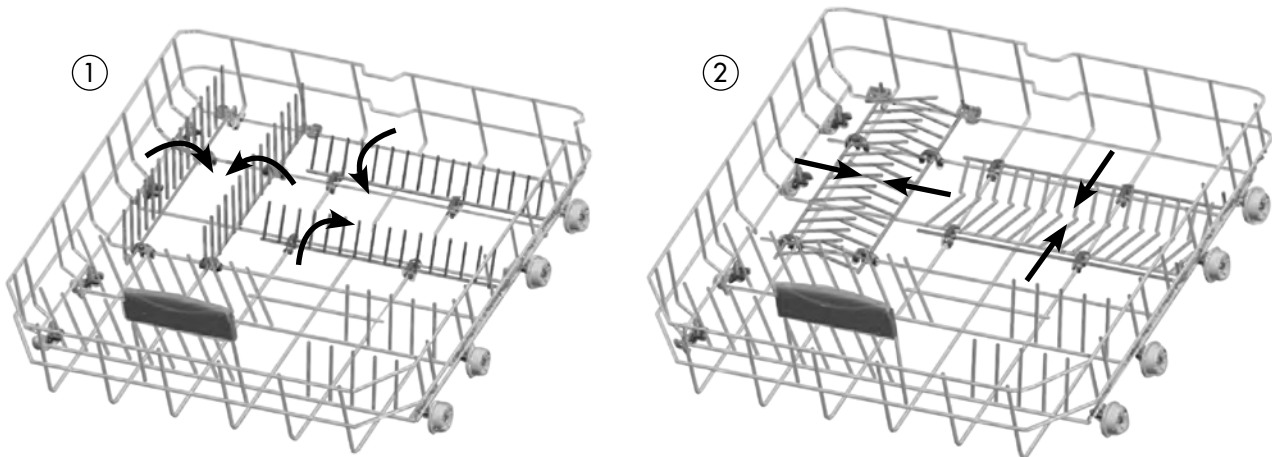

ALTERNATE CUTLERY BASKET

An alternate cutlery basket has been provided for convenience. The cutlery basket handle is adjustable - position (a) or (b). The basket can be used in the upper or lower dishwasher basket as required.

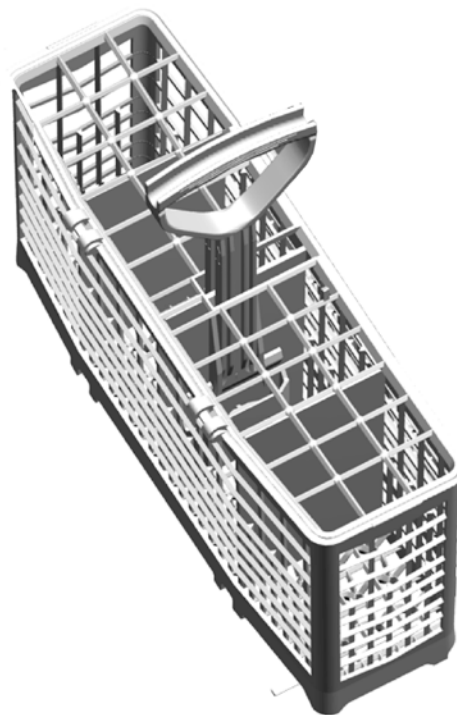
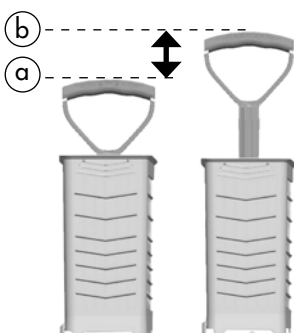

LOADING YOUR DISHWASHER

ALTERNATIVE BASKET LOADS

Lower Basket

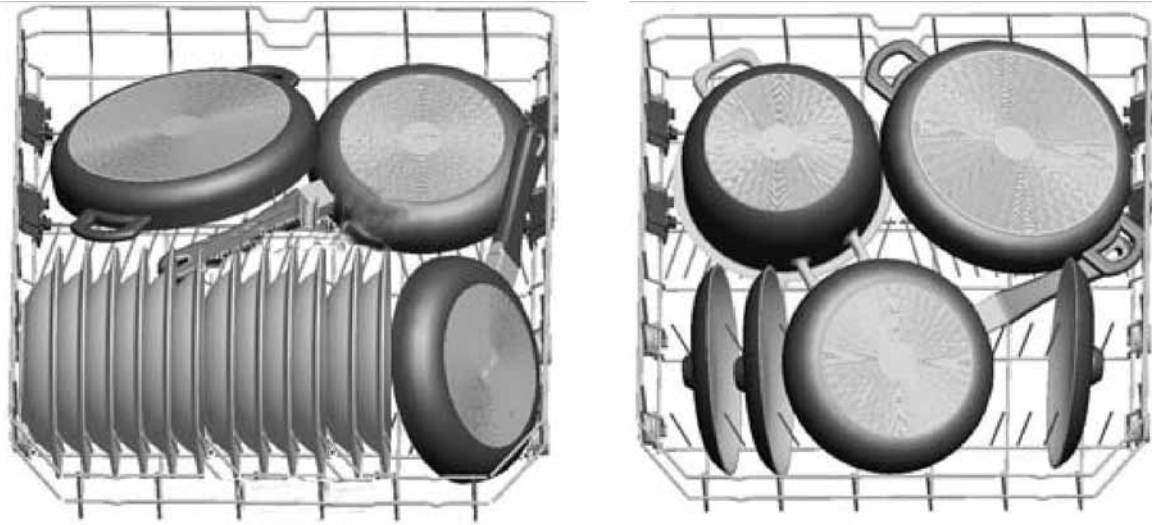

* Illustration only

Top Basket

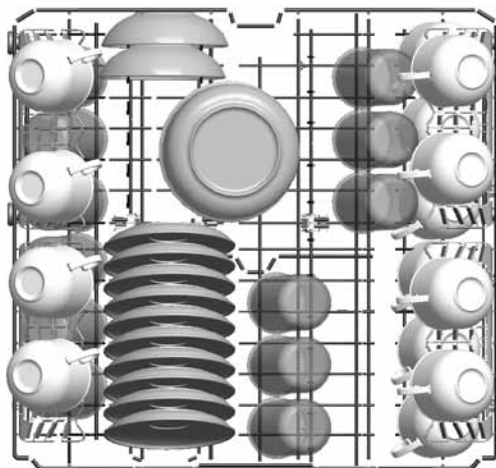

TIPS AND INFORMATION

Examples of incorrect loading

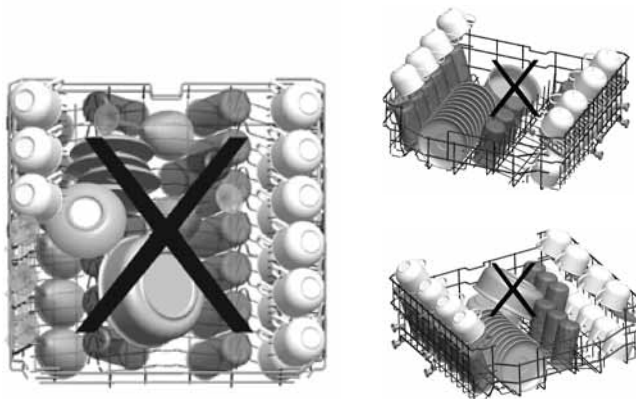

AS/NZS STANDARD LOADING AND TEST DATA

INFORMATION FOR TEST LABORATORIES

For all the necessary information for performance testing,
send an email to

dishwasher@standardtest.com

In your mail please provide the model number and
PNC number (9 digits) that is on the rating plate on the
appliance door.

PROGRAM DESCRIPTIONS

PROGRAM ITEMS

NAME OF PROGRAM	RINSE	FAST 30	ECO	TIME SAVE	HEAVY	AUTO 30-50	AUTO 50-60	AUTO 60-70
WASHING TEMPERATURE	-	40°C	50°C	65°C	60°C	30-50°C	50-60°C	60-70°C
TYPE OF FOOD SOILS	Fresh, less dirty, coffee, milk, tea	Fresh coffee, milk, tea, cold meat, vegetables	Fresh coffee, milk, tea, cold meat, vegetables	Baked on soup, sauce, pastry, egg, rice, potato and meats cooked in oven, fried food	Fresh coffee, milk, tea, cold meat, vegetables	Detects contamination level of dishes and sets temperature and amount of washing water and washing period automatically		
LEVEL OF FOOD SOILS	Small	Small	Medium	Medium	Medium	Small	High	High
AMOUNT OF DETERGENT A: 25gm/ 15gm B: 5gm	-	A: 15	A: 25 B: 5	A: 25 B: 5	A: 25 B: 5	A: 25	A: 40 B: 5	A: 40 B: 5
	Pre-wash	40°C Wash	30°C Wash	65°C Wash	Pre-wash	Detects contamination level of dishes and sets temperature and amount of washing water and washing period automatically		
	Finish	Cold Rinse	50°C Wash	Intermediate Rinse	60°C Wash			
		Hot Rinse	Cold Rinse	Hot Rinse	Cold Rinse			
		End	Hot Rinse	End	Hot Rinse			
			Dry		Dry			
			End		End			
PROGRAM TIME (mins)	15	30	159	50	90	64 - 92	100 - 127	111 - 183
POWER CONSUMPTION (kW hour)	0.02	0.78	0.95	1.21	1.34	0.76 - 0.95	1.09 - 1.40	1.22 - 1.85
WATER CONSUMPTION (Litres)	4.2	10.9	13.5	10.7	14.4	10.6 - 17.7	10.9 - 18.5	12.3 - 24.6

** Only powder detergent should be used in cycle of prewash program.

WARNING

Short programs do not include a drying step. The values declared above are the values obtained under laboratory conditions according to relevant standards. These values can change depending on conditions of product's use and environment (network tension, water pressure, water input temperature and environment temperature).

SWITCHING ON THE MACHINE AND SELECTING A PROGRAM

SWITCHING ON THE MACHINE



PROGRAM FOLLOW-UP

You can follow the program flow using the program follow-up lamps located on the control panel.



CHANGING A PROGRAM

If you would like to change programs while a washing program is continuing.

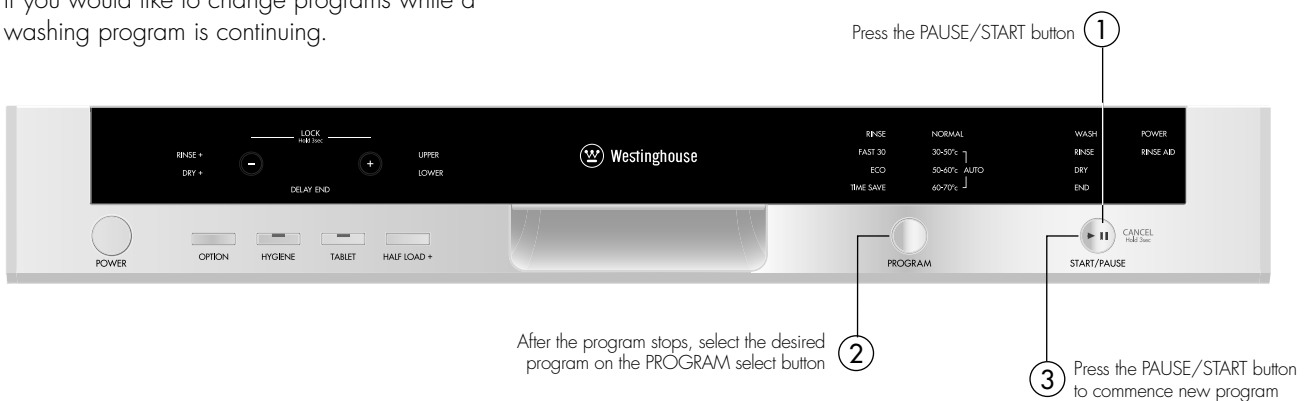

CHANGING A PROGRAM WITH RESETTING

If you would like to cancel a program while a washing program is resumed.



SWITCHING THE MACHINE OFF

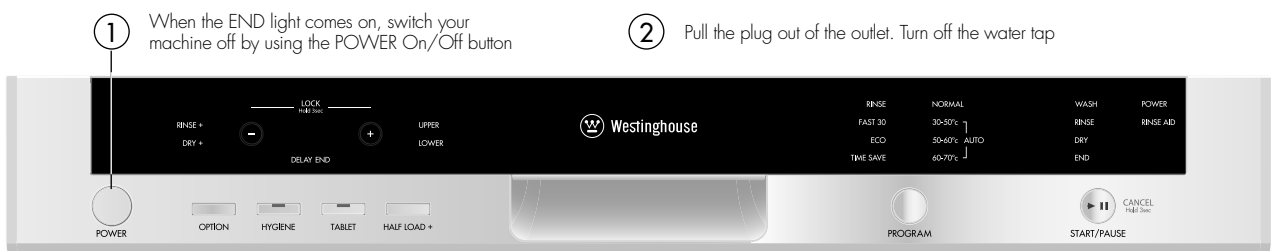

TIPS AND INFORMATION

NOTE: If the machine door is opened during washing or the power is cut off, the machine resumes the program when the door is shut or the power comes back.

NOTE: For better drying results, when the program has finished keep the door ajar for some minutes before you remove the dishes.

MAINTENANCE AND CLEANING

Cleaning the machine in regular intervals prolongs the machine's service life.

Oil and lime may accumulate in the machine's washing section. In case of such accumulation:

Fill the detergent compartment with detergent without loading any dishes into the machine, select a program that runs at high temperature, and start the machine. Alternatively, use descaling material available in the market. (Dishwasher cleaners produced by detergent manufacturers.)

CLEANING THE SEALS IN THE MACHINE DOOR

To clean any accumulated residues in the door seals, wipe the seals regularly by using a dampened cloth.

CLEANING THE MACHINE

Clean the filters and spray arms at least once a week. Unplug your machine and turn off its tap before starting the cleaning. Do not use abrasive materials when cleaning your machine. Wipe with a fine cleaning material and a dampened cloth.

FILTERS

Check if any food wastes have remained on the coarse and fine filters. If any food wastes are left, remove the filters and clean them thoroughly under the water tap.

- a. Micro Filter
- b. Coarse Filter
- c. Metal/Plastic Filter

- 1 To remove and clean the filter combination, turn it counter clockwise and take it out by lifting upwards.
- 2 Pull and remove the metal/plastic filter.
- 3 Then pull the coarse filter out of the micro filter. Rinse it with water under the tap. Refit the metal/plastic filter. Insert the coarse filter into the micro filter in a way that the marks will correspond to one another.
- 4 Attach micro filter into the metal/plastic filter and turn to the direction of arrow and it is locked when the arrow on micro filter can be seen from across.
- 5 Never use your dishwasher without any filter.
- 6 Incorrect fitting of the filter will reduce the washing effectiveness.
- 7 Clean filters are very important in terms of the proper running of the machine.

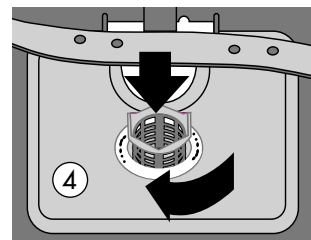
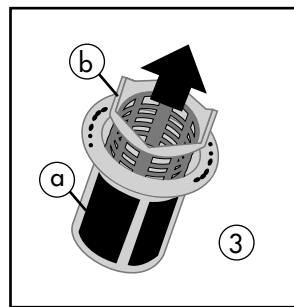
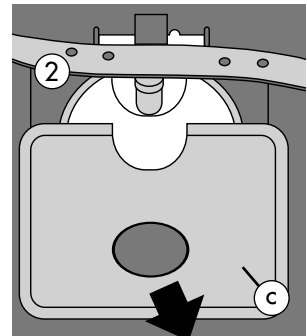
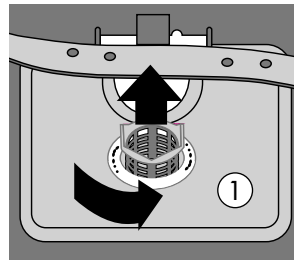

MAINTENANCE AND CLEANING

SPRAY ARMS

Check whether or not the holes for the upper and lower spray arms are clogged. If there is any clogging, remove the spray arms and clean them under water.

You can remove the lower spray arm by pulling it upwards, while the upper spray arm nut can be removed by turning the nut to the left. Be sure that the nut is perfectly tightened when refitting the upper spray arm.

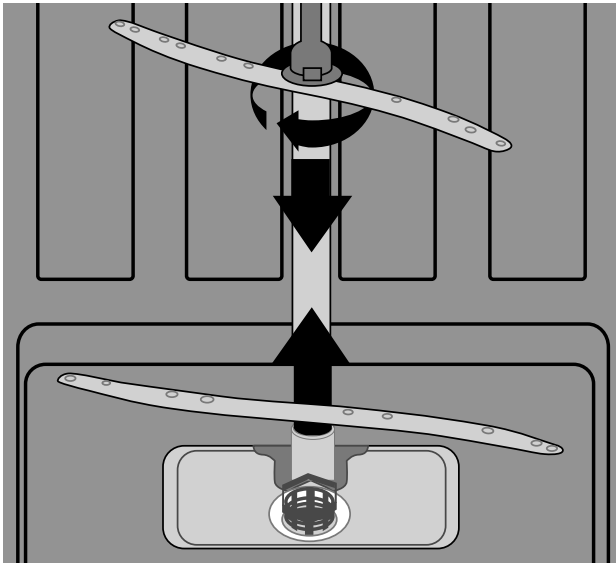

HOSE FILTER

The inlet hose filter reduces contamination (sand, clay, rust etc.) that might be occasionally carried in through the main's water supply or the indoor plumbing, and avoids damage to dishwasher components. Check the filter and the hose from time to time and clean them if necessary. To clean the filter, first turn off your tap and then remove the hose. After removing the filter from the hose, clean it under the tap. Insert the cleaned filter back into its place inside the hose. Refit the hose and check that there are no leaks.

FAILURE CODES AND WHAT TO DO IN CASE OF FAILURE

ERROR CODE	ERROR DESCRIPTION	CONTROL
F5	Inadequate water supply	<ul style="list-style-type: none"> • Make sure the water tap is open and that main water supply is on. • Close the water tap, separate the water inlet hose from the tap and clean the filter at the connection end of the hose. • Restart your machine, contact the service centre if the error resumes.
F3	Error of continuous water input	<ul style="list-style-type: none"> • Close the tap. • Contact the service centre.
F2	The waste water in the machine cannot be discharged	<ul style="list-style-type: none"> • Water drain hose is clogged. • Spigot on sink tap is blocked. • The filters of your machine might be clogged. • Power off your machine and activate the program cancellation command. • Check the drain spigot's membrane has been removed or blocked. • If the error continues, contact the service centre.
F8	Heater error	Contact the service centre.
F1	Alarm is active against water overflow	<ul style="list-style-type: none"> • Power off your machine and close the tap. • Contact the service centre.
FE	Faulty electronic card	• Contact the service centre.
F7	Overheating error (temperature in the machine is too high)	• Contact the service centre.
F9	Flow Control Valve position error	• Contact the service centre.
F6	Faulty heater sensor	• Contact the service centre.

PRACTICAL AND USEFUL INFORMATION

- Whenever you will not be operating your machine:
 - Unplug the machine and then turn the water off.
 - Leave the door slightly ajar in order to prevent the formation of unpleasant odours.
 - Keep the machine interior clean.
- Eliminating water droplets:
 - Wash the dishes with the intensive program.
 - Increase the rinse aid setting.
 - If plastic items are washed, water drops on these items will be unavoidable. Programs with higher temperatures and increased rinse aid settings may reduce the water drops. Check that the plastic items are suitable for dishwasher use.
- Correctly loaded dishes will give the best energy consumption, washing and drying performance.
- Clean all rough waste before you place dirty dishes in the machine.
- Operate the machine after it is completely full.
- Use pre-washing program only when necessary.
- Observe program information and average consumption values table when selecting a program.
- Since the machine will reach high temperatures, it should not be installed near a refrigerator.
- If the appliance is located in a place where the risk of freezing exists, you must completely drain the water that has remained in the machine. Turn off the water tap, disconnect the water inlet hose from the tap and allow the interior water to drain.

TROUBLESHOOTING

PROBLEM	SOLUTION
If one of program monitor lights is on and start/pause light is flashing	<ul style="list-style-type: none"> Your machine's door is open, shut the door.
If the program won't start	<ul style="list-style-type: none"> Check if the plug is connected. Check your indoor fuses. Be sure that the water inlet tap is turned on. Be sure that you have closed the machine door. Be sure that you switched off the machine by pressing the Power On/Off button. Be sure that the water inlet filter and the machine filters are not clogged. First time use: Check if the drain spigot's membrane has been removed or spigot blocked.
If the control lamps won't go out after a wash operation	<ul style="list-style-type: none"> The Power On/Off button is released yet.
If detergent residues are left in the detergent compartment	<ul style="list-style-type: none"> Detergent has been added when the detergent compartment was wet.
If water is left inside the machine at the end of the program	<ul style="list-style-type: none"> The water drain hose is clogged or twisted. The filters are clogged. The program is not finished yet.
If the machine stops during a wash operation	<ul style="list-style-type: none"> Power failure. Water inlet failure. Program can be on standby mode.
If shaking and hitting noises are heard during a wash operation	<ul style="list-style-type: none"> Dishes placed incorrectly. Spray arm hitting the dishes.
If there are partial food wastes left on the dishes	<ul style="list-style-type: none"> Dishes placed incorrectly into the machine, sprayed water did not reach related places. Basket overly loaded. Dishes leaning against one another. Very small amount of detergent added. An unsuitable, rather weak wash program selected. Spray arm clogged with food wastes. Filters clogged. Filters incorrectly fitted. Water drain pump clogged.
If there are whitish stains on the dishes	<ul style="list-style-type: none"> A very small amount of detergent is being used. Rinse aid dosage setting at a very low level.
If the dishes won't dry up	<ul style="list-style-type: none"> A programme without a dry operation selected. Rinse aid dosage set too low. Dishes unloaded too fast.
If there are rust stains on the dishes	<ul style="list-style-type: none"> Stainless-steel quality of the dishes washed is insufficient. Unhealthy mains grounding.

Call an authorised service centre if the problem still persists after the controls or in case of any malfunction not described above.

This document sets out the terms and conditions of the product warranties for Electrolux Appliances. It is an important document. Please keep it with your proof of purchase documents in a safe place for future reference should you require service for your Appliance.

1. In this warranty:
 - (a) 'acceptable quality' as referred to in clause 10 of this warranty has the same meaning referred to in the ACL;
 - (b) 'ACL' means Schedule 2 of the Competition and Consumer Act 2010;
 - (c) 'Appliance' means any Electrolux product purchased by you and accompanied by this document;
 - (d) 'ASC' means Electrolux authorised service centres;
 - (e) 'Electrolux' means Electrolux Home Products Pty Ltd of 163 O'Riordan Street, Mascot NSW 2020, ABN 51 004 762 341 in respect of Appliances purchased in Australia and Electrolux (NZ) Limited (collectively 'Electrolux') of 3-5 Niall Burgess Road, Mount Wellington, in respect of Appliances purchased in New Zealand;
 - (f) 'major failure' as referred to in clause 10 of this warranty has the same meaning referred to in the ACL and includes a situation when an Appliance cannot be repaired or it is uneconomic for Electrolux, at its discretion, to repair an Appliance during the Warranty Period;
 - (g) 'Warranty Period' means the Appliance is warranted against manufacturing defects in Australia for 24 months and in New Zealand for 24 months, following the date of original purchase of the Appliance;
 - (h) 'you' means the purchaser of the Appliance not having purchased the Appliance for re-sale, and 'your' has a corresponding meaning.
2. This warranty only applies to Appliances purchased and used in Australia or New Zealand and used in normal domestic applications and is in addition to (and does not exclude, restrict, or modify in any way) any non-excludable statutory warranties in Australia or New Zealand.
3. During the Warranty Period Electrolux or its ASC will, at no extra charge if your Appliance is readily accessible for service, without special equipment and subject to these terms and conditions, repair or replace any parts which it considers to be defective. Electrolux or its ASC may use remanufactured parts to repair your Appliance. You agree that any replaced Appliances or parts become the property of Electrolux. This warranty does not apply to light globes, batteries, filters or similar perishable parts.
4. Parts and Appliances not supplied by Electrolux are not covered by this warranty.
5. To the extent permitted by law, you will bear the cost of transportation, travel and delivery of the Appliance to and from Electrolux or its ASC. If you reside outside of the service area, you will bear the cost of:
 - (a) travel of an authorised representative;
 - (b) transportation and delivery of the Appliance to and from Electrolux or its ASC.

In all instances, unless the Appliance is transported by Electrolux or an Electrolux authorised representative, the Appliance is transported at the owner's cost and risk while in transit to and from Electrolux or its ASC.
6. Proof of purchase is required before you can make a claim under this warranty.
7. You may not make a claim under this warranty unless the defect claimed is due to faulty or defective parts or workmanship. Electrolux is not liable in the following situations (which are not exhaustive):
 - (a) the Appliance is damaged by:
 - (i) accident
 - (ii) misuse or abuse, including failure to properly maintain or service
 - (iii) normal wear and tear
 - (iv) power surges, electrical storm damage or incorrect power supply
 - (v) incomplete or improper installation
 - (vi) incorrect, improper or inappropriate operation
 - (vii) insect or vermin infestation
 - (viii) failure to comply with any additional instructions supplied with the Appliance;
 - (b) the Appliance is modified without authority from Electrolux in writing;
 - (c) the Appliance's serial number or warranty seal has been removed or defaced;
 - (d) the Appliance was serviced or repaired by anyone other than Electrolux, an authorised repairer or ASC.
8. This warranty, the contract to which it relates and the relationship between you and Electrolux are governed by the law applicable where the Appliance was purchased. Where the Appliance was purchased in New Zealand for commercial purposes the Consumer Guarantee Act does not apply.
9. To the extent permitted by law and subject to your non-excludable statutory rights and warranties, Electrolux excludes all warranties and liabilities (other than as contained in this document) including liability for any loss or damage whether direct or indirect arising from your purchase, use or non use of the Appliance.
10. For Appliances and services provided by Electrolux in Australia, the Appliances come with a guarantee by Electrolux that cannot be excluded under the ACL. You are entitled to a replacement or refund for a major failure and for compensation for any other reasonably foreseeable loss or damage. You are also entitled to have the Appliance repaired or replaced if the Appliance fails to be of acceptable quality and the failure does not amount to a major failure. The benefits to you given by this warranty are in addition to your other rights and remedies under a law in relation to the Appliances or services to which the warranty relates.
11. At all times during the Warranty Period, Electrolux shall, at its discretion, determine whether repair, replacement or refund will apply if an Appliance has a valid warranty claim applicable to it.
12. For Appliances and services provided by Electrolux in New Zealand, the Appliances come with a guarantee by Electrolux pursuant to the provisions of the Consumer Guarantees Act, the Sale of Goods Act and the Fair Trading Act.
13. To enquire about claiming under this warranty, please follow these steps:
 - (a) carefully check the operating instructions, user manual and the terms of this warranty;
 - (b) have the model and serial number of the Appliance available;
 - (c) have the proof of purchase (e.g. an invoice) available;
 - (d) telephone the numbers shown below.
14. You accept that if you make a warranty claim, Electrolux and its ASC may exchange information in relation to you to enable Electrolux to meet its obligations under this warranty.

Important Notice

Before calling for service, please ensure that the steps listed in clause 13 above have been followed.

<p>FOR SERVICE or to find the address of your nearest state service centre in Australia PLEASE CALL 13 13 49 For the cost of a local call (Australia only)</p>	<p>SERVICE AUSTRALIA  Electrolux ELECTROLUX HOME PRODUCTS www.electrolux.com.au</p>	<p>FOR SPARE PARTS or to find the address of your nearest state spare parts centre in Australia PLEASE CALL 13 13 50 For the cost of a local call (Australia only)</p>
<p>FOR SERVICE or to find the address of your nearest authorised service centre in New Zealand FREE CALL 0800 10 66 10 (New Zealand only)</p>	<p>SERVICE NEW ZEALAND  Electrolux ELECTROLUX (NZ) Limited www.electrolux.co.nz</p>	<p>FOR SPARE PARTS or to find the address of your nearest state spare parts centre in New Zealand FREE CALL 0800 10 66 20 (New Zealand only)</p>

**For more information on all Westinghouse appliances,
or for dimension and installation information, call into your retailer,
phone or email our customer care team or visit our website:**

AUSTRALIA

phone: 1 300 363 640
fax: 1 800 350 067
email: customercare@electrolux.com.au
web: www.westinghouse.com.au

NEW ZEALAND

phone: 09 573 2384
fax: 0800 363 600
email: customercare@electrolux.co.nz
web: www.westinghouse.co.nz

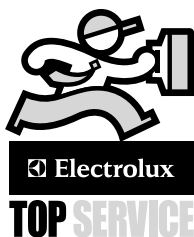

TOP SERVICE

Top Service encompasses the after sales service provided by The Electrolux Group to consumers including delivery, home service and spare parts.

**Westinghouse. We are part of the Electrolux family.
Share more of our thinking at www.electrolux.com**

P/No: 5208 2734 Issue: B

© 2013 Electrolux Home Products Pty Ltd
ABN 51 004 762 341
WMAN_WSF6608_Oct13