

omega

installation
and operating
instructions



omega
DW2006
Dishwasher

1. Safety and operating instructions	4
2. Installation and hook-up	7
3. Description of the controls	10
4. Operating instructions	19
5. Cleaning and maintenance	27
6. Troubleshooting	31

*Thank you for choosing this product.
We advise you to carefully read all the instructions contained in this manual, in order to understand how to operate your dishwasher safely and correctly.
The manual is divided into paragraphs, which provide a step by step description of the dishwasher functions, with clear instructions accompanied by detailed illustrations.
Recommendations are given for the correct use of the baskets, spray arms, containers, filters, washing programs, and for operating the controls.
Follow the recommended cleaning procedures to ensure that your dishwasher always remains in perfect working order.
This manual provides a quick and easy reference for answering all your questions concerning the use of your new dishwasher.*



INSTALLATION INSTRUCTIONS: these are intended for the **qualified technician** who must carry out the installation, hook-up and testing of the appliance.



USER INSTRUCTIONS: these consist of recommendations for using the appliance, a description of its controls and of the correct cleaning and maintenance procedures.

1. Safety and operating instructions

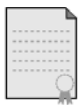

THIS MANUAL FORMS AN INTEGRAL PART OF THE APPLIANCE: IT MUST ALWAYS BE KEPT INTACT TOGETHER WITH THE DISHWASHER. BEFORE USING THE APPLIANCE, CAREFULLY READ ALL THE INSTRUCTIONS CONTAINED IN THIS MANUAL.

INSTALLATION MUST BE PERFORMED BY A QUALIFIED TECHNICIAN, IN COMPLIANCE WITH THE REGULATIONS IN FORCE. THIS APPLIANCE IS INTENDED FOR DOMESTIC USE, AND COMPLIES WITH THE **EEC DIRECTIVES 72/23, 89/336 (INCLUDING 92/31)** CURRENTLY IN FORCE, INCLUDING THE PREVENTION AND ELIMINATION OF RADIO FREQUENCY INTERFERENCE.

THE APPLIANCE IS DESIGNED FOR THE FOLLOWING PURPOSE: **WASHING AND DRYING OF DISHES**; ANY OTHER USE SHALL BE CONSIDERED IMPROPER. **THE MANUFACTURER DECLINES ALL RESPONSIBILITY FOR USES OTHER THAN THOSE DESCRIBED ABOVE.**



THE NAME PLATE FEATURING THE TECHNICAL DATA, SERIAL NUMBER AND MARKINGS IS VISIBLY POSITIONED ON THE INNER EDGE OF THE DOOR. **THE NAME PLATE ON THE INNER EDGE OF THE DOOR MUST NEVER BE REMOVED.**



DO NOT LEAVE THE DISCARDED PACKAGING MATERIALS UNSUPERVISED WITHIN THE HOME. SEPARATE THE VARIOUS MATERIALS WHICH MAKE UP THE PACKAGING AND TAKE THEM TO THE NEAREST SORTED WASTE COLLECTION CENTRE.



THE APPLIANCE MUST BE PROVIDED WITH AN EARTH CONNECTION IN ACCORDANCE WITH THE ELECTRICAL SAFETY REGULATIONS IN FORCE.

THE MANUFACTURER DECLINES ALL RESPONSIBILITY FOR DAMAGE TO PERSONS OR PROPERTY RESULTING FROM THE FAILURE TO EARTH THE APPLIANCE OR FROM A DEFECTIVE EARTH CONNECTION.



IF THE APPLIANCE IS INSTALLED ON A CARPETED OR COVERED FLOOR, ENSURE THAT THE OPENINGS ON ITS UNDERSIDE ARE NOT OBSTRUCTED.

ALWAYS SWITCH OFF THE DISHWASHER AFTER EACH USE TO AVOID WASTING ELECTRICITY.



OBSOLETE APPLIANCES MUST BE RENDERED UNUSABLE. CUT OFF THE MAINS POWER CORD AFTER UNPLUGGING IT FROM THE WALL OUTLET, AND MAKE SAFE ANY COMPONENTS WHICH MIGHT BE DANGEROUS FOR CHILDREN (LOCKS, DOORS, ETC.).



THIS APPLIANCE IS MARKED ACCORDING TO THE **EUROPEAN DIRECTIVE 2002/96/EC** ON WASTE ELECTRICAL AND ELECTRONIC EQUIPMENT (**WEEE**). BY ENSURING THIS PRODUCT IS DISPOSED OF CORRECTLY, YOU WILL HELP PREVENT POTENTIAL NEGATIVE CONSEQUENCES FOR THE ENVIRONMENT AND HUMAN HEALTH, WHICH COULD OTHERWISE BE CAUSED BY INAPPROPRIATE WASTE HANDLING OF THIS PRODUCT.



THE SYMBOL  ON THE PRODUCT, OR ON THE DOCUMENTS ACCOMPANYING THE PRODUCT, INDICATES THAT THIS APPLIANCE MAY NOT BE TREATED AS HOUSEHOLD WASTE. INSTEAD IT SHALL BE HANDED OVER TO THE APPLICABLE COLLECTION POINT FOR THE RECYCLING OF ELECTRICAL AND ELECTRONIC EQUIPMENT. DISPOSAL MUST BE CARRIED OUT IN ACCORDANCE WITH LOCAL ENVIRONMENTAL REGULATIONS FOR WASTE DISPOSAL. FOR MORE DETAILED INFORMATION ABOUT TREATMENT, RECOVERY AND RECYCLING OF THIS PRODUCT, PLEASE CONTACT YOUR LOCAL CITY OFFICE, YOUR HOUSEHOLD WASTE DISPOSAL SERVICE OR THE SHOP WHERE YOU PURCHASED THE PRODUCT.

IN THE EVENT OF A FAULT, DISCONNECT THE DISHWASHER FROM THE ELECTRICAL POWER SUPPLY AND SHUT OFF THE WATER TAP.



DO NOT USE APPLIANCES WHICH HAVE BEEN DAMAGED DURING TRANSIT! IF IN DOUBT, CONSULT YOUR DEALER. THE APPLIANCE MUST BE INSTALLED AND CONNECTED IN ACCORDANCE WITH THE INSTRUCTIONS PROVIDED BY THE MANUFACTURER OR BY A QUALIFIED TECHNICIAN.



THE APPLIANCE IS INTENDED FOR USE BY ADULTS. DO NOT ALLOW CHILDREN TO COME NEAR OR PLAY WITH THE DISHWASHER. KEEP CHILDREN AWAY FROM DETERGENTS AND FROM THE OPEN DISHWASHER DOOR. THE PACKAGING MATERIALS (PLASTIC BAGS, POLYSTYRENE, METAL BARS, ETC.) MUST NOT BE LEFT WITHIN THE REACH OF CHILDREN. KEEP CHILDREN AWAY FROM THE OPEN DISHWASHER. THE APPLIANCE MAY CONTAIN RESIDUES OF DETERGENT WHICH CAN CAUSE IRREVERSIBLE DAMAGE TO THE EYES, MOUTH, AND THROAT, AS WELL AS POSSIBLE DEATH BY SUFFOCATION.



DO NOT INTRODUCE SOLVENTS SUCH AS ALCOHOL OR TURPENTINE WHICH MAY CAUSE AN EXPLOSION.

DO NOT LOAD DISHES THAT ARE SOILED WITH ASH, WAX OR PAINTS.

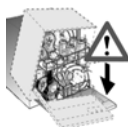

LEANING OR SITTING ON THE DISHWASHER DOOR WHEN OPEN MAY CAUSE THE APPLIANCE TO OVERTURN, PUTING PEOPLE AT RISK. NEVER LEAVE THE DISHWASHER DOOR OPEN; PEOPLE MIGHT TRIP OVER IT.



DO NOT DRINK THE WATER RESIDUES WHICH MAY BE PRESENT INSIDE THE DISHES OR DISHWASHER AT THE END OF THE WASHING PROGRAM AND BEFORE THE DRYING CYCLE.



KNIVES OR OTHER SHARP-ENDED COOKING UTENSILS MUST BE PLACED IN THE CUTLERY BASKET BLADE-DOWN, OR LAID HORIZONTAL IN THE TOP BASKET. TAKE CARE NOT TO CUT YOURSELF AND ENSURE THAT THEY DO NOT PROJECT FROM THE BASKET.



AQUASTOP MODELS

THE AQUASTOP DEVICE PREVENTS FLOODING IN THE EVENT OF A WATER LEAK. WHEN THE AQUASTOP DEVICE IS TRIPPED, CALL IN A QUALIFIED TECHNICIAN TO IDENTIFY AND REPAIR THE FAULT.

IN MODELS EQUIPPED WITH THE AQUASTOP DEVICE, THERE IS A SOLENOID VALVE INSIDE THE WATER INTAKE HOSE. **DO NOT CUT THE HOSE AND DO NOT ALLOW THE SOLENOID VALVE TO DROP INTO WATER.** IN THE EVENT OF DAMAGE TO THE WATER INTAKE HOSE, DISCONNECT THE APPLIANCE FROM THE ELECTRICAL POWER SUPPLY AND FROM THE WATER SUPPLY.



IMMEDIATELY AFTER INSTALLING THE DISHWASHER, PERFORM A QUICK TEST OF THE APPLIANCE FOLLOWING THE INSTRUCTIONS BELOW. IF THE DISHWASHER FAILS TO OPERATE CORRECTLY, DISCONNECT IT FROM THE ELECTRICAL POWER SUPPLY AND CALL THE NEAREST TECHNICAL SERVICE CENTRE. **DO NOT ATTEMPT TO REPAIR THE APPLIANCE.**



THE DISHWASHER MEETS ALL THE REQUIREMENTS SET OUT BY THE REGULATIONS IN FORCE CONCERNING SAFETY AND ELECTRICAL EQUIPMENT. ANY TECHNICAL CHECKS SHOULD BE CONDUCTED EXCLUSIVELY BY A TRAINED AND AUTHORISED TECHNICIAN: **REPAIRS CARRIED OUT BY UNAUTHORISED PERSONS WILL INVALIDATE THE WARRANTY, AS WELL AS POSING A POTENTIAL HAZARD TO THE USER.**

The manufacturer declines all responsibility for damage to persons or property resulting from failure to observe the above precautions, from tampering with even a single component of the appliance, or from the use of non original spare parts.



2. Installation and hook-up

Remove the polystyrene basket retainers.

Position the appliance in the desired place of installation. The back or sides of the dishwasher may be placed up against walls or other furniture units. If the dishwasher is installed near a heat source, fit the special insulating panel to prevent overheating and malfunction of the appliance. To ensure stability, install integrated or built-under dishwashers only under continuous worktops, and screw them to the adjacent units. To facilitate the installation procedure, the intake and drain hoses can be positioned in any direction; make sure that the hoses are not kinked, crushed or pulled too tightly. Make sure to tighten the locking ring-nut once the pipes have been placed in the direction required. A hole at least 8 cm in diameter is required to allow the power supply cable and pipes to pass.

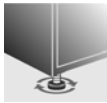

Level the appliance on the floor using its adjustable feet. This operation is essential for ensuring correct operation of the dishwasher.



Building-in a dishwasher underneath a ceramic hob is *absolutely forbidden*.

*A dishwasher can be built-in underneath a conventional hob provided there is **no break** in the kitchen worktop, and the dishwasher and hob are **installed and secured correctly**, so that **no hazards are generated**.*

For free-standing models only

- *Installing a hob on top of a free-standing dishwasher is **absolutely forbidden**.*
- *If the appliance is not built-in and is therefore accessible on one side, the door hinge area must be covered for safety reasons (injury hazard). The covering fixtures are available as an accessory from specialist dealers or the After-Sales Service.*
- *To build in the dishwasher, the **special kit** must be purchased from authorised dealers or the After-Sales Service.*



2.1 Water supply connection

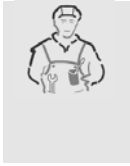

Preventing the risk of clogging or damage: if the water pipe is new or has not been used for a long time, before connecting to the water supply check that the water is clear and free of impurities, to prevent damage to the appliance. **The dishwasher must always be connected to the water system with new hoses; old or used hoses must never be reused.**

CONNECTING TO THE WATER SUPPLY

Connect the intake hose to a cold water supply with $\frac{3}{4}$ " gas thread, inserting the filter **A** supplied with the dishwasher. **Take care to screw the hose firmly into place with your hands and then complete by tightening about $\frac{1}{4}$ of a turn with pliers.**

In dishwashers equipped with the **ACQUASTOP** device, the filters is already fitted inside the threaded ring.

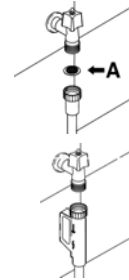

The dishwasher can also be connected to a hot water supply **not exceeding 60°C**. Supplying the appliance with hot water cuts down the washing time by approximately 20 minutes, but slightly reduces its effectiveness. Make the connection to the domestic hot water supply using the same procedure described for connecting to the cold water supply.



DRAIN CONNECTION

Insert the dishwasher's drain hose into a drain pipe having a diameter of at least **4 cm**, or alternatively, place it inside the kitchen sink using the plastic support provided, taking care not to crush or excessively bend the hose. It is important to prevent the hose from coming loose and falling. For this purpose, the plastic support is equipped with a hole for tying it to the wall or water tap.

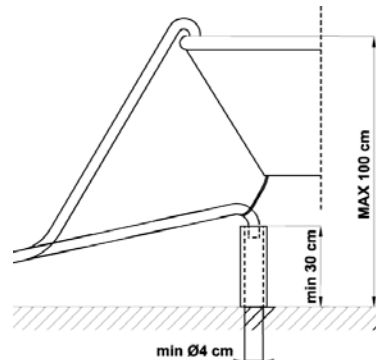

The free end should be positioned at a height of between **30 and 100 cm**, and should never be submerged in water. If a horizontal drain extension hose is used (for a maximum of 3 m) the drain hose can be placed at a maximum height of **85 cm** from the ground.



2.2 Electrical connection and precautions



CHECK THAT THE VOLTAGE AND THE FREQUENCY OF THE MAINS MATCH THE RATINGS ON THE NAME PLATE OF THE APPLIANCE POSITIONED ON THE INNER EDGE OF THE DOOR.



THE PLUG ON THE SUPPLY CORD AND THE CORRESPONDING SOCKET OUTLET MUST BE OF THE SAME TYPE AND MEET THE REGULATIONS IN FORCE.

THE PLUG MUST BE ACCESSIBLE AFTER INSTALLATION.

NEVER DISCONNECT THE PLUG BY PULLING ON THE POWER SUPPLY LEAD.

IN THE EVENT OF DAMAGE TO THE SUPPLY CORD, HAVE IT REPLACED BY THE MANUFACTURER OR AN AUTHORIZED TECHNICAL SERVICE CENTRE.



DO NOT USE ADAPTORS OR SHUNT CONNECTIONS IN ORDER TO AVOID THE POSSIBILITY OF OVERHEATING OR BURNING.



In the event of damage to the supply cord, have it replaced by the manufacturer or an Authorized Technical Service Centre in order to avoid any risk.



3. Description of the controls

3.1 Front panel

All the dishwasher control are grouped on the front panel. Programming and option selection are only possible with the **door closed**.

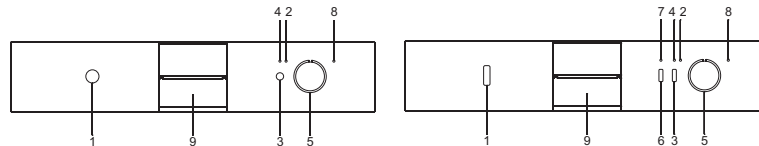

1	ON/OFF BUTTON
2	ON/OFF LIGHT
3	START/PAUSE BUTTON
4	START/PAUSE LIGHT
5	PROGRAMS SELECTOR
6	HALF LOAD BUTTON (on some models only)
7	HALF LOAD LIGHT (on some models only)
8	NO RINSE AID LIGHT
9	RECESSED DOOR HANDLE

○ Light off

● Light on

☼ Light flashing



SETTING THE WASHING PROGRAM

To select the most suitable program for the dishes to be washed refer to the table below, which indicates the most appropriate program according to dish type and degree of soiling.

PROGRAM	SELECTION	TYPE AND GRADE DIRT	PROGRESS PROGRAM	DURATION	CONSUMPTION	
				MINUTES (1)	WATER LITRES	POWER kWh (1)
SOAK		PANS AND DISHES IN WAITING OF COMPLETING THE LOAD	Cold prewash	12'	7	0,03
DELICAT		PANS AND DISHES NORMAL DIRTY WITHOUT DRY RESIDUALS	Cold prewash Wash at 45°C Cold rinse Rinse at 68°C Dry	75'	17	1,15
NORMAL ECO (*)		PANS AND DISHES NOT VERY DIRTY BUT WITH DRY RESIDUALS	Cold prewash Wash at 40°C Cold rinse Rinse at 45°C Dry	117'	16,9	0,70
NORMAL		PANS AND DISHES NORMAL DIRTY WITH DRY RESIDUALS	Cold prewash Wash at 65°C Cold rinse Rinse at 68°C Dry	95'	20	1,42
SUPER		PANS AND DISHES VERY DIRTY WITH DRY RESIDUALS	Prewash at 45°C Wash at 70°C 2 cold rinses Rinse at 70°C Dry	110'	20	1,75

Only run the soak program with half loads.

The **HALF LOAD** option (6) is available for all programs **except the soak program**.

(*) Reference program as AS/NZS 2007 (NORMAL ECO).

(1) The cycle duration and power consumption may vary according to the water and room temperatures, and the type and amount of dishes.

The washing cycle will not take place if the dishwasher door is left open or not properly closed.



TABLE FOR CERTIFICATION BODIES

Reference standard	AS/NZS 2007
Reference program	(*) Selector on NORMAL ECO
Load	12 place-settings
Type of detergent	in accordance with AS/NZS 2007
Amount of detergent	pour 10g of cleaner on to the appliance door and 20g into the dispenser
Rinse aid setting	4/6

 *The door can be opened at the end of the cycle approximately **50 mm** for improved drying performance.*

AS/NZS 2007 cycle test conditions:

 *The **upper** basket must be set in the low position.*

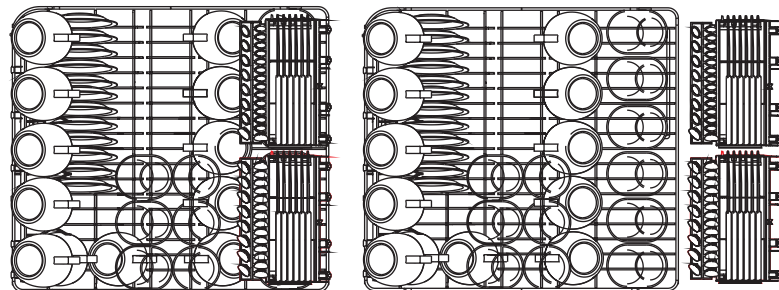
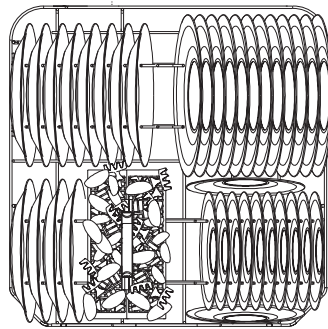

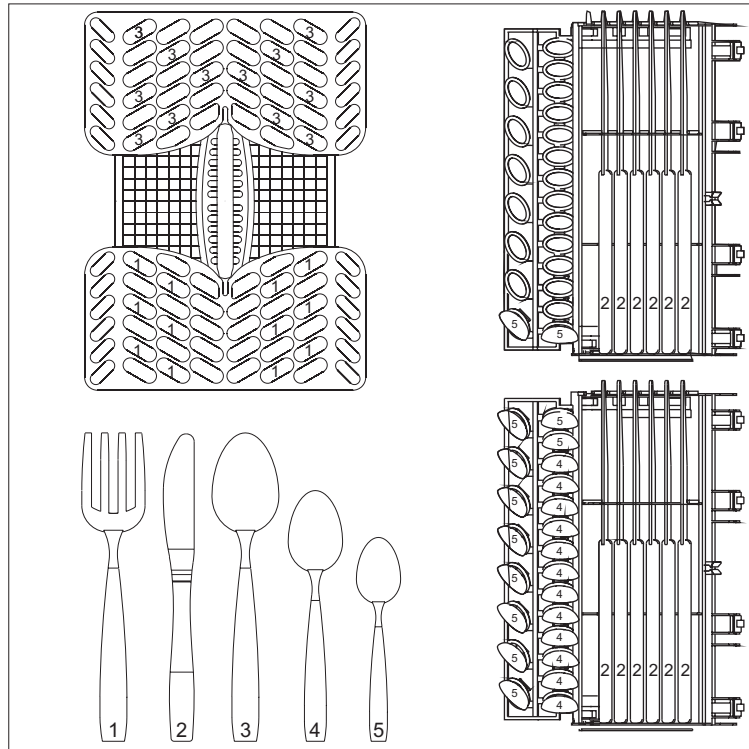



3.2 Washing programs

The dishwasher is equipped with a control panel, described in chapter "1. Description of the controls", from which it is possible to carry out all the power switch-on, switch-off and programming operations.



Before starting a washing program make sure that:

- The water supply tap is **open**.
- The **correct amount of detergent** has been added to the **dispenser**.
- The baskets have been **correctly loaded**.
- The spray arms are able to **rotate freely** and without obstruction.
- The dishwasher door is **securely closed**.

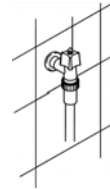

LIGHTING

When the **ON/OFF** button (1) is pressed, the dishwasher switches on. The **ON/OFF** (2) and **START/PAUSE** (4) lights will indicate one of the following states:

- ▼end▼

Program start
Dishwasher ready to execute a new program.

- ▼end▼

Program end
Door closed and washing program over.

- ▼end▼

Alarm
Alarm state (see chapter "Troubleshooting").

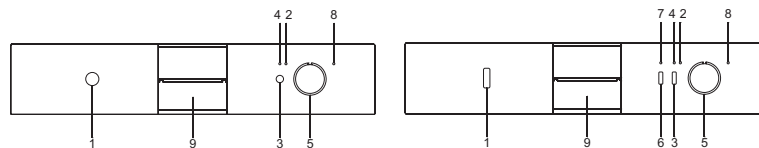



PROGRAMMING

All programming operations are only possible with the **door closed**. To select a new program, the dishwasher must be in the "**Program start**" state described above. Turn the **PROGRAM SELECTOR (5)** to the program of your choice (see "**PROGRAMS TABLE**").

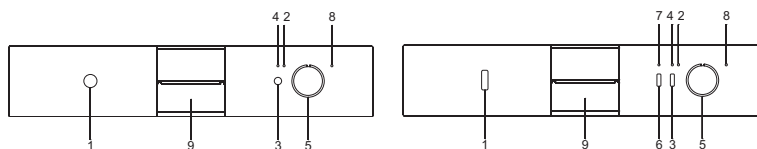

START PROGRAM

Press the **START/PAUSE** button (3) for a few seconds, until the **START/PAUSE** light (4) starts to flash. A beep confirms the operation.



PROGRAM SEQUENCE

For the entire duration of the program, **ON/OFF** (2) indicator light remains permanently on, whereas the **START/PAUSE** (4) indicator light flashes.



END PROGRAM

To indicate the end of the program, a short beep sounds and the **ON/OFF** (2) and **START/PAUSE** (4) lights illuminate simultaneously.

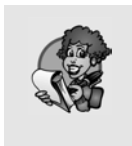

*Before a new washing cycle can be selected the dishwasher must be in "**Program start**" state: press the **START/PAUSE** button (3) until the configuration of indicator lights (2) and (4) is as follows.*



INTERRUPTION OF A PROGRAM

Press the **START/PAUSE** button (3) for a few seconds, until the configuration of the **ON/OFF** (2) and **START/PAUSE** (4) lights is as follows.



You may now restart ("**START PROGRAM**") or change the program which was interrupted.



TO CHANGE A PROGRAM

To change the running program it is necessary:

- to interrupt the running program (see “**INTERRUPTION OF A PROGRAM**”);
- select the new program;
- to press again the **START/PAUSE** button (3) to make start the new program.

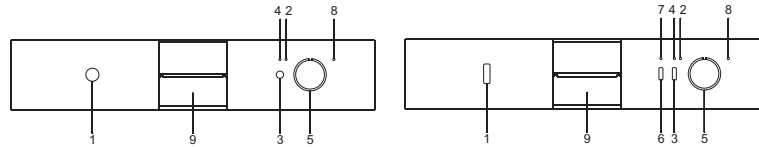

ANNULLING A PROGRAM

To annul the program in progress, it must first be interrupted (see “**INTERRUPTION OF A PROGRAM**”).

Turn the **PROGRAM SELECTOR** (5) to any point on the "empty" sector (with no symbols) on the left of the selector and start the dishwasher.

After the water has discharged from the tank, the **ON/OFF** (2) and **START/PAUSE** (4) lights will both remain on. ▼end▼
● ●



*If the door is opened with the dishwasher in operation, the appliance switches to "Pause" state, indicated by a series of beeps and the following configuration of the **ON/OFF** (2) and **START/PAUSE** (4) lights.* ▼end▼
● ○

Once the door has been closed again, the "START PROGRAM" procedure already described must be repeated. The washing cycle will restart from the point where it was interrupted.

In case that the tub temperature is higher than 50°C the program will start about 30 seconds later.



If the dishwasher door is not properly closed, the washing cycle will not start.



HALF LOAD WASH FUNCTION (on some models only)

Pressing button $\frac{1}{2}$ **LOAD WASH (6)** selects washing on the top basket only.

After selecting the program, proceed as follows:

- press the $\frac{1}{2}$ **LOAD WASH button (6)** once to select washing in the top basket only;
- Press the button **(6)** again to return to the full load washing mode (washing in both baskets).



The option is disabled at the end of the cycle.

WARNING: dishes and cutlery placed in the basket not selected will not be washed.

INDICATOR LIGHT CONFIGURATION FOR HALF-LOAD WASHING (7)



Washing in **top** basket only.



Washing in **both** baskets.



**TO SAVE ON ENERGY! ... AND PROTECT THE ENVIRONMENT**

- Always try to run the dishwasher **fully loaded**.
- Do not wash the dishes in running water.
- Use the washing program that is **most appropriate** for each type of load.
- Do not carry out any preliminary rinsing.
- If available, connect the dishwasher to a hot water supply up to 60°C.

TO CUT DOWN ON DETERGENT CONSUMPTION! ... AND PROTECT THE ENVIRONMENT

The phosphates contained in dishwasher detergents are harmful to the environment. To avoid using excessive amounts of detergent and to save on electricity, observe the following:

- **separate** the more delicate items from dishes that are more resistant to aggressive detergents and high temperatures;
- **do not pour** the detergent directly on the dishes.

REMOVING THE DISHES

At the end of the washing program, wait at least **20 minutes** before removing the dishes, to allow them to cool down. To prevent any water droplets on the upper basket from falling on the dishes in the lower basket, it is **advisable** to unload the lower basket first, and then the upper basket.



4. Operating instructions

Once the dishwasher has been correctly installed, prepare for use as follows:

- Add the rinse aid and detergent.



ADDING THE RINSE AID

The rinse aid helps the dishes dry faster and prevents the formation of scale deposits and staining; it is automatically added to the water during the final rinse cycle, from the container situated on the inner side of the door.

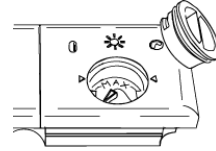

To add rinse aid:

- Open the door.
- Rotate the container cap anticlockwise by $\frac{1}{4}$ of a turn and remove it.
- Add the rinse aid until the container is full (approximately 140 cc). The optical level indicator on the side of the cap should be completely obscured. Refill the rinse aid when the optical level indicator becomes clear again, or when the rinse aid warning light illuminates.
- Replace the cover and turn it in a clockwise direction.
- Use a cloth to remove any spillage of rinse aid which might lead to the formation of excess foam.

ADJUSTING THE RINSE AID DISPENSER SETTING

The dishwasher is factory set for medium water hardness. However it is possible to change the setting by turning the dispenser's selector to the desired position: the amount of rinse aid dispensed is proportional to the selector position.

- To adjust the rinse aid setting, rotate the dispenser cap through a quarter turn in an anticlockwise direction and remove it.
- Then use a screwdriver to rotate the rinse aid selector to the desired position.
- Replace the cap, turning it clockwise.



- *The amount of rinse aid must be **increased** if the washed dishes appear dull or feature circular stains.*
- *If, on the other hand, the dishes are sticky or have white streaks, it is necessary to **reduce** the rinse aid setting.*



ADDING THE DETERGENT

To open the detergent dispenser cap, lightly press the button **P**. Add the detergent and close the cap carefully.

During the washing cycle, the dispenser will be opened automatically.

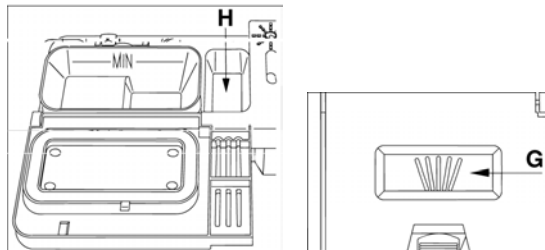

- When a **SUPER** program is selected, in addition to the normal dose of detergent, it is necessary to add an additional amount inside compartment **G** or **H**.
- Use **only** detergents specially formulated for dishwashers. For optimal washing results it is important to use a good quality detergent.
- The detergent packs must be sealed and stored in a dry place to prevent the formation of lumps which may negatively affect washing results. Once opened the detergent packs should not be kept for too long, otherwise the detergent loses its effectiveness.
- Do not use detergents formulated for washing dishes by hand, because they produce a great deal of foam and may negatively affect the operation of the dishwasher.
- Add the correct amount of detergent. An insufficient amount of detergent will result in a partial removal of dirt from the dishes, whereas an excessive amount is wasteful and does not improve the washing results.



- The market offers liquid and powder detergents with differing chemical compositions, which may contain **phosphates**, or be phosphate-free but contain **natural enzymes**.
 - Detergents containing **phosphates** are more effective against grease and starch at **temperatures above 60°C**.
 - **Enzyme** detergents, on the other hand, are also effective at lower temperatures (**from 40 to 55°C**) and are more easily biodegradable. With enzyme detergents it is possible to obtain at low temperatures comparable results to those which can only be achieved at **65°C** using traditional detergents.For the safeguarding of the environment we recommend the use of **phosphate- and chlorine free** detergents.

- Also available are tablet detergents which state that that no salt or rinse aid is required. In some cases, these detergents might not give good results, especially with short and/or low-temperature washing cycles.

If performance problems (e.g. a white coating on the tank or dishes, poor drying, dirt on dishes at the end of the wash) are noted, users are advised to return to conventional products (granular salt, powder detergent and liquid rinse aid).

However, please note that on return to the use of conventional salt, a number of cycles will be required before the system becomes fully efficient again, so traces of white coating may still be found on the tank and dishes. If the problem persists for too long, contact the After-Sales Service.

- When using detergent in tablet form (bear in mind that we recommend the use of three separate products: detergent, salt and rinse aid), place the tablets in the cutlery rack. The dispenser is designed to use powder or liquid detergent and the door does not open completely during the washing cycle. This means that a tablet is not completely dissolved (released), which may lead to the following:
 - not enough detergent released during the cycle, with poor washing results;
 - the detergent forms a solid block in the distributor and is released during the final rinse cycle.



The introduction of detergent into the rinse aid dispenser, even in liquid form, will damage the dishwasher.



4.1 General warnings and recommendations



Before using the dishwasher for the first time, it is advisable to read the following recommendations concerning **dish types** to be washed and their **loading**.

There are generally no constraints on the washing of domestic dishes, but in certain cases it is necessary to take their characteristics into account.

Before loading the dishes into the baskets it is necessary to:

- remove coarse food remains: e.g. bones, fish-bones, etc. which may clog the filter or damage the wash pump.
- soak any pots or pans with burnt-on food remains on the bottom to facilitate removal, then load them into the LOWER BASKET.

If a small quantity of dishes has to be washed, use the “**½ load wash**” option; this saves electricity and water.

Remember to load the upper basket only; the lower basket must be left empty.

There is no need to pre-wash the dishes under running water before loading them into the baskets since this only wastes water.

Correct loading of the dishes helps ensure optimal washing results.

WARNING!

- Make sure that the dishes are securely in place so that they cannot tip over or obstruct the rotation of the spray arms during the washing cycle.
- Do not place very small objects in the baskets as these could fall and obstruct the spray arms or the wash pump.
- Containers such as cups, bowls, glasses and pots should always be loaded with the opening facing downwards and with any cavities at an angle, to allow the water to drain out.
- Do not stack dishes or place them in such a way that they cover one other.
- Do not place glasses too close together because they may knock against each other and break, or there might be staining at the point where they touch.

MAKE SURE that the items being washed are dishwasher-safe.



Items which are not dishwasher-safe:

- **Wooden dishes, pots or pans:** these may be damaged by the high washing temperatures.
- **Handcrafted items:** these are rarely suitable for washing in a dishwasher. The relatively high water temperatures and the detergents used may damage them.
- **Plastic dishes:** heat resistant plastic dishes must be washed in the upper basket.
- **Dishes and objects in copper, tin, zinc or brass:** these tend to stain.
- **Aluminium dishes:** items made from anodised aluminium may lose their colour.
- **Silverware:** silver items may stain.
- **Glass and crystal:** in general, glass and crystal objects can be washed in the dishwasher. However, certain types of glass and crystal may become dull and lose their clearness after many washings. Therefore, for these items we recommend using the least aggressive program available.
- **Decorated items:** the decorated objects available on the market are generally able to withstand washing in the dishwasher, although the colours may fade after a great many washes. If in doubt as to the fastness of the colours, it is advisable to wash just a few items at a time for approximately one month.



4.2 Using the baskets

The dishwasher has a capacity of **12 place-settings**, including serving dishes.

LOWER BASKET

The lower basket receives the full force of the lower spray arm, and should therefore be used for the “toughest” items with a heavier degree of soiling.

All types and combinations of loads are permitted, provided that the dishes, pots and pans are arranged with all the soiled surfaces exposed to the water jets coming from the bottom.



LOADING THE LOWER BASKET

Carefully load flat plates, soup plates, dessert and serving dishes, positioning them vertically. Pots, pans and their covers must be loaded upside down. When loading soup plates and dessert bowls, be sure to leave a gap between them.

Loading examples:

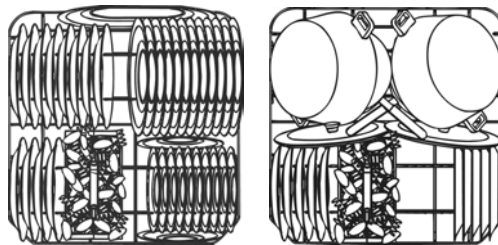



CUTLERY BASKET

The basket has removable top grids into which items of cutlery can be inserted to keep them properly spaced and allow water to pass between them effectively.

The function of the central lid is only a cover. Do not add cutlery.

The cutlery should be arranged in an orderly manner inside the basket, with the handles pointing downwards. Take care during loading to avoid injury from the knife blades. The basket is suitable for all types of cutlery, except those long enough to interfere with the upper spray arm. Ladles, wooden spoons and cooking knives can be placed in the upper basket, **making sure that the knife blades do not protrude from the basket.**



UPPER BASKET

It is recommended to load the upper basket with small- or medium-sized items such as glasses, small plates, tea or coffee cups, shallow bowls and light objects made from heat resistant plastic. If the upper basket is used in the lowermost position, it can also be loaded with serving dishes, provided they are only slightly soiled.

The top basket is fitted (on the left) with two plastic racks which can be raised to make room for tall glasses, such as stem glasses.

On the right there are two cutlery racks designed to take knives and teaspoons; when not in use, they can be left vertical, attached to the basket.

To use the space designed for teaspoons, remove the insert as shown in the illustrations.

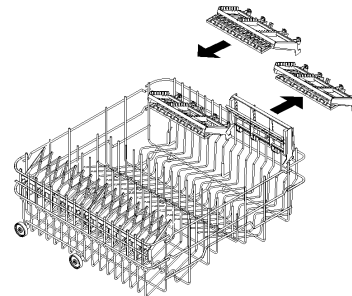



LOADING THE UPPER BASKET

Load the dishes with the top side facing forwards; cups and concave containers should always be loaded with the opening facing down. The left side of the basket can be loaded with cups and glasses on two levels. In the centre section, plates and saucers can be loaded vertically into the supports provided.

Loading examples:

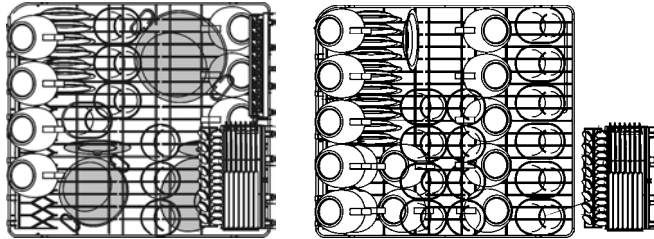

ADJUSTING THE UPPER BASKET

The upper basket can be adjusted in **two positions**, according to the user's needs and according to the height of the dishes in the lower basket.

Proceed as follows:

- pull out the right-hand basket guide;
- remove the stop, first releasing it as shown in the diagram;
- push the guide to free the wheels;
- fit the upper or lower pair of wheels into the guide, depending on the setting required;
- return the stop to its original position.

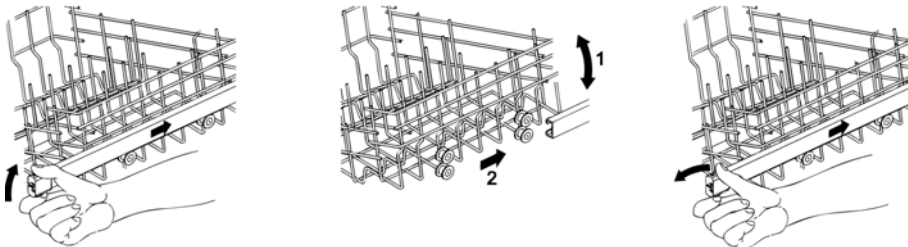



5. Cleaning and maintenance



Before carrying out any work, always unplug the appliance from the electrical supply or switch off the all-pole disconnection device.

5.1 General warnings and recommendations

Avoid the use of acidic or abrasive detergents.

Clean the outer surfaces and door-lining of the dishwasher regularly using a soft cloth moistened with water or with a normal detergent suitable for painted surfaces. Clean the door gaskets with a damp sponge. Periodically (once or twice a year) it is advisable to clean the tank and gaskets, using a soft cloth and water to remove any deposits.

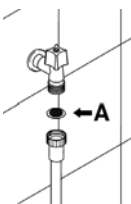

CLEANING THE WATER INTAKE FILTER

The water intake filter **A** located at the outlet of the water supply tap needs to be cleaned periodically.

After having closed the water supply tap, unscrew the end of the water intake hose, remove the filter **A** and clean it delicately under running water. Reassemble filter **A** in its seat and carefully screw the water intake hose back into position.

CLEANING THE SPRAY ARMS

The spray arms can be easily removed for periodic cleaning of the nozzles, to prevent possible clogging. Wash them under running water and carefully replace them in their seats, **checking that their rotary movement is in no way impeded.**

- To remove the **upper** spray arm, unscrew locking ring **R**.
- To remove the **lower** spray arm, simply lift it up, pulling by the central part.
- To remove the **orbital** spray arm assembly, take hold of the longer arm and pull the orbital unit upward. Wash the arms under a jet of running water and return them carefully to their seat. **After reassembly, check that the spray arms turn freely.** Otherwise, check that they have been installed correctly.

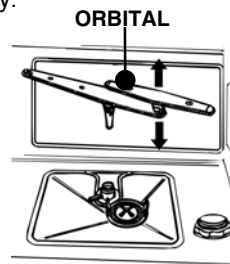
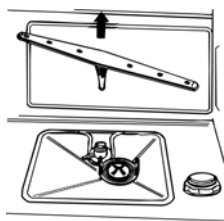
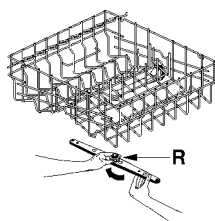



CLEANING THE FILTER UNIT

- It is advisable to periodically inspect the centre filter **C** and, if necessary, to clean it. To remove the filter, grip the tabs, turn them anticlockwise and lift upwards;
- push the centre filter **D** from the underside to remove it from the micro-filter;
- separate the two parts which make up the plastic filter by pressing the body of the filter in the zone shown by the arrows;
- remove the centre filter by lifting it upwards.

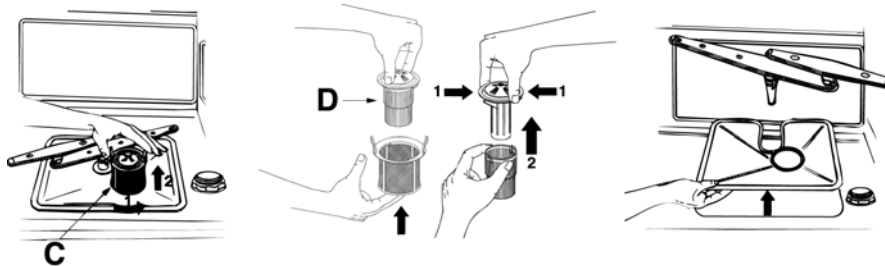

GENERAL WARNINGS AND RECOMMENDATIONS FOR CORRECT MAINTENANCE:

- The filters should be cleaned **under running water** using a stiff brush.
- It is essential to **thoroughly clean the filters** according to the above instructions: the dishwasher cannot function if the filters are clogged.
- **Carefully replace** the filters in their seats, to avoid damaging the wash pump.

PROLONGED DISUSE:

- Run the soak program twice in succession.
- **Unplug** the power cord from the socket.
- **Leave the door slightly open**, in order to prevent the formation of unpleasant odours inside the washing tank.
- **Fill the rinse aid dispenser.**
- **Shut off the water supply tap.**



BEFORE STARTING THE DISHWASHER AFTER PROLONGED DISUSE:

- Check that there are no deposits of sludge or rust inside the water pipe: if there are, allow the water to run from the water supply tap for a few minutes.
- **Plug the power cord** back into the socket.
- **Reconnect the water intake hose and open the tap again.**

TROUBLESHOOTING MINOR PROBLEMS

In some cases it is possible to remedy minor problems by referring to the following instructions:

If the program fails to start, check that:

- the dishwasher is connected to the electrical power supply;
- there is no power failure;
- the water tap is open;
- the dishwasher door is properly closed.

If water remains inside the dishwasher, check that:

- the drain hose is not kinked;
- the drain siphon is not obstructed;
- the dishwasher filters are not clogged.

If the dishes are not being cleaned properly, check that:

- the correct amount of detergent has been added;
- the dishes are being loaded correctly;
- the selected program is suitable for the dish types and their degree of soiling;
- all the filters are clean and positioned correctly;
- the spray arm nozzles are not obstructed;
- there is no object obstructing the rotation of the spray arms.



If the dishes fail to dry or remain dull, check that:

- there is rinse aid inside the special container;
- the rinse aid dispenser setting is correct;
- the detergent used is of good quality and has not lost its effectiveness (for example, through incorrect storage, with the box left open).

If the dishes show signs of streaking, staining, etc., check that:

- the rinse aid dispenser setting is not too high.

If there are visible traces of rust inside the tank:

- the tank is made of steel, and therefore any rust marks are due to external elements (fragments of rust from the water pipes, pots, cutlery, etc.). Special products are commercially available to remove such marks;
- check that the amount of detergent being used is correct. Certain detergents can be more corrosive than others;





If after following the above troubleshooting instructions the problem persists, call the nearest After-Sales Centre.

WARNING: any operations performed on the appliance by unauthorised persons are not covered by the warranty and shall be paid for by the user.



6. Troubleshooting

In case of a malfunction, the dishwasher will warn the user by flashing the **ON/OFF (2)** and **START/PAUSE (4)** lights, in some cases combined with a continuous beep.

LIGHTS	DESCRIPTION
	<ul style="list-style-type: none"> - The dishwasher is not able to fill or discharge the tank. - Temperature sensor disconnected (on some models only). - Alternate washing system malfunction (on some models only). - Water level at limit (on some models only).
 + continuous beep	<ul style="list-style-type: none"> - Anti-flooding system or safety level switch tripped.

In some cases, the alarm signal may indicate a temporary problem, so before contacting the after-sales service, proceed as follows.

- Open and close the door, or switch the dishwasher off and back on, and if necessary reprogram it.



If the problem persists, contact the after-sales service.

TECHNICAL DATA	
Width	597 ÷ 599 mm
Depth measured flush with the outer edge of the control panel	Free standing: 600 mm Semi-integrated: 570 mm
Height	Free standing from 850 mm to 870 mm Semi-integrated from 820 mm to 870 mm
Capacity	12 Standard place settings
Water supply pressure	min. 0,05 - max. 0,9 MPa (min. 0.5 – max. 9 bar)
Electrical characteristics	See rating plate

Misurare l'altezza del pannello comandi; fare coincidere l'indice relativo a tale valore con il profilo superiore della porta in legno; tracciare il posizionamento degli agganci porta.
 Measure the height of the control panel; bring the mark relating to this value in line with the top edge of the wooden door; mark the position of the door connections.
 Mesurer la hauteur du panneau de commandes; faire coïncider l'index relatif à cette valeur avec le profil supérieur de la porte en bois; tracer le positionnement des crochets de la porte.
 Die Höhe des Bedienfelds messen; in diesem Wertensprechende Markierung mit dem oberen Profil der Holztür zur Deckung bringen; die Position der Tür aufhängungen anzeichnen.
 Meet de hoogte van het bedieningspaneel; laat de markering bij de hoogte overeenstemmen met het bovenste profiel van de houten deur; tekende positieve van de deurgangels af.
 Medir la altura del panel de mandos; hacer coincidir el índice correspondiente a dicho valor con el perfil superior de la puerta de madera; trazar el posicionamiento de las bisagras de la puerta.
 Межаа алтур до painel de comandos; фаџа ком коинцидор релативо а ест валор коинцида ком опер филсупериор до порта де madeira; марке а позиџа до ганчос пар порта.

115
125
135
145
155

115
125
135
145
155

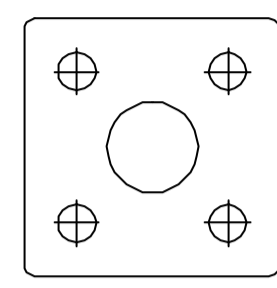
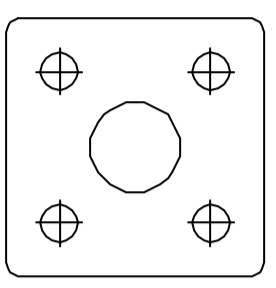

19 570 0055 00

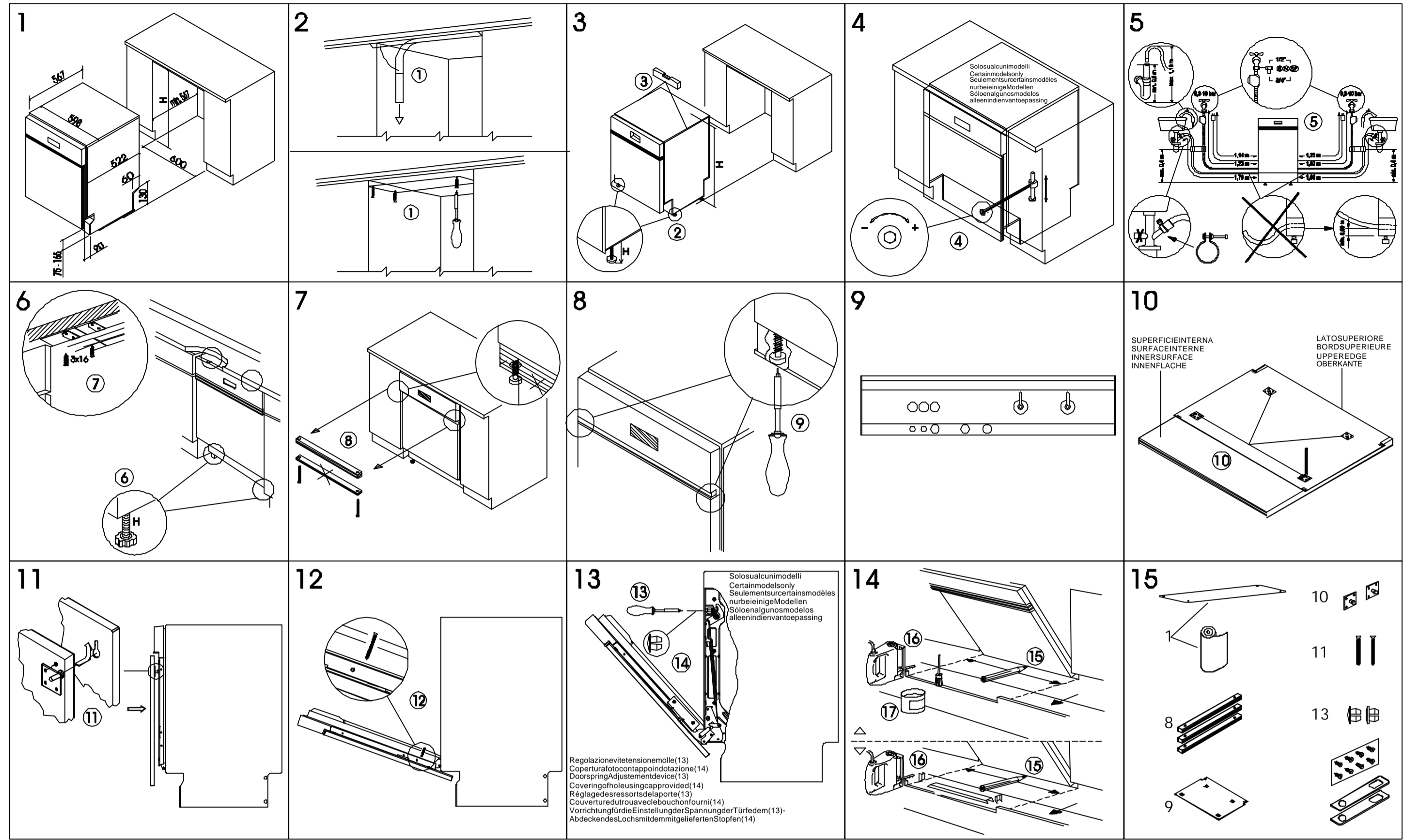

ATTENZIONE:
Montare la porta e regolare la tensione delle molle laterali prima dell'installazione.

IMPORTANT:
Door template, do not destroy. Fit door and adjust hinge tension before installation.

ATTENTION:
Après montage de la porte, régler la tension des ressorts latéraux avant l'installation.

WICHTIG:
Tür montieren, Türfedern vor Einbau einstellen.

ATENÇÃO:
Antes da instalação, monte a porta e regule a tensão das molas laterais.

IMPORTANTE:
Montar la puerta y regular los muelles laterales antes de la instalación.

NOTA: Solamente alcuni modelli sono dotati di uno dei dispositivi sotto illustrati. **N.B.:** Only some models are equipped with one of the two devices illustrated below. **REMARQUE:** seul quelques modèles sont munis de l'un des deux dispositifs illustrés ci-dessus.

ANMERKUNG: Nur einige Modelle verfügen über eine der beiden unten dargestellten Einrichtungen. **NOTABENE:** uitsluitend bepaalde modellen zijn uitgerust met één van de twee onderstaand afgebeelde inrichtingen. **NOTA:** Sólo algunos modelos están equipados con uno de los dos dispositivos que se ilustra en la continuación.

Sicurezza contro gli allagamenti
Questo sistema di sicurezza protegge il vostro appartamento da danni dell'acqua. In caso di guasto al tubo di entrata o permeabilità del sistema della macchina, l'entrata dell'acqua viene interrotta.
La scatola della sicurezza anti-allagamento montata sul tubo, contiene parti elettriche. E' pertanto proibito collocare la scatola stessa nell'acqua. Nel caso in cui per una ragione qualsiasi la scatola subisca danni, togliere immediatamente la presa di collegamento dalla rete elettrica.

Aquastop-Verlängerung
Im Handel können längere Aquastopschläuche gekauft werden, die von einem Fachmann mit dem bestehenden Aquastopschlauch ausgetauscht werden müssen. Bei einer eigenmächtigen Verlängerung des Wasserzufuhrschlauches trägt der Hersteller keine weitere Verantwortung.

"Aquastop" por septuplicado
El sistema "AQUASTOP" por septuplicado protege su vivienda de forma fiable e de daños por escapes de agua. Se corta inmediatamente el suministro de agua en caso de cualquier fuga en tubos o en componentes del aparato. El cajón de válvulas del tubo aquastop contiene componentes eléctricos. Por este motivo no debe sumergirse en agua. En caso de que el cajón de válvulas estuviera dañado, debe desconectarse de la red eléctrica, desenchufando la clavija.

HR AQUASTOP - Zашита pred poplavom
Ovaj sigurnosni sistem štiti vaš stan od štete koju može uzrokovati voda. U slučaju kvara na dovodnoj cijevi ili u slučaju propuštanja na sistemu stroja za pranje posuđa, prekida se dovod vode. Kućište ventila, odnosno sigurnosne naprave, namješteno na cijevi, sadrži električne dijelove. Zato je ne smijete potopiti u vodu. U slučaju da se kutija iz bilo kojeg razloga ošteti, odmah isključite aparat iz električne mreže.

Aquastop safety device
The AQUASTOP is safety device. The aquastop assures that the fresh water hose need only take the stress of water pressure during the actual timer water is flowing. If the hose should begin to leak during this time, the magnetic valve in the water spout cuts off the flow, and the hose is relieved of pressure. Operating pressure DIN 44995.
The valve casing on the water-stop hose contains electrically controlled components. It is should not, therefore, be submerged in water. If the housing becomes damaged the plug must be removed from the socket.

SLO AQUASTOP - Zашита pred poplavo
Ta vamostni sistem varuje vaše stanovanje pred škodo, ki bi jo povzročila voda. V primeru okvare na dovodni cevi ali v primeru puščanja na sistemu pomivalnega stroja, se prekine dovod vode. Ohišje ventila oz. Varnostne naprave, ki je namještena na cev, vsebuje električne dele. Zato je ne smete potopiti v vodo. V primeru, da se ta škoda iz kakršnegakoli razloga poškoduje, nemudoma izklopite aparat iz električnega omrežja.

YU AQUASTOP - Зашита пред поплаво
Ovaj безбедносni систем ваш стан од штете коју може да узрокује вода. У случају квара на доводној цевии или у случају прекида се овога воде. Кућиште вентила односно безбедносне направи, монтиране на цевии, саджи електричне делове. Зато не смејте да је потапујете у воду. Ус случају да се кутија из било ког разлога оштети, одмах искључите апарат из електричне мреже.

МК AQUASTOP - Зашита од поплава
Oboj заштитен систем го штити вашиот стан од поплава. Во случају на оштетување на доводната цевка или пак ако пропушта систем во машината за миење садови, се прекинува доводот на вода. Куќиштето на вентилот односно на сигурносната направа која е наместена на цевката, содржи електрични делови и затоа не смеете да ја потопите во вода. Ако се случи од било какви причини куќиштето да се оштети, апаратот веднаш исклучете го од електричната мрежа.

Aquastop
Dieses Wasserschutz-System schützt Ihre Wohnung zuverlässig vor Wasserschäden. Bei undichtigem Wasserzulaufschlauch oder undichtigem Maschinensystem wird jeglicher weiterer Wasserzulauf unterbunden. Der Ventilkasten am Wasserstop Schlauch beinhaltet elektrisch gesteuerte Bauteile. Er darf deshalb nicht in Wasser getaucht werden. Sollte der Ventilkastengehäuse beschädigt sein, ist unbedingt der Netzstecker aus zu ziehen.

Paliers de sécurité pour empêcher les fuites
Le système est doté de sept paliers de sécurité pour éviter les fuites d'eau et protège ainsi votre logement contre d'éventuels dégâts matériels. Si le tuyau d'arrivée d'eau n'est pas étanche ou si la machine fuit, ce dispositif arrête l'écoulement d'eau. Le boîtier de sécurité qui contrôle l'arrivée d'eau est situé sur le tuyau et contient des parties électriques. Il ne faut donc pas le tremper dans l'eau. S'il est endommagé pour une raison quelconque, débranchez immédiatement l'appareil en retirant la prise.

Dispositivo di bloccaggio dell'acqua
Il tubo di carico dell'acqua è provvisto di un dispositivo di sicurezza che blocca l'afflusso dell'acqua qualora il tubo di carico si deteriori. Questo fatto viene segnalato dall'apparizione di una tacca rossa nella finestrella "A". In questo caso, il tubo di carico acqua dovrà essere necessariamente sostituito.

Water-stop system
The water-stop device protects against water damages caused by leaks on the hose which could develop due to natural ageing of the hose. In the water-stop system the leaking water fills the corrugated hose and activates a stop valve which cuts off the water supply to the machine.
This fault is shown by a red sector on the window "A". Should this occur, please refer to your Service Agent.

Dispositif de blocage de l'eau
Le tuyau d'alimentation est équipé d'un dispositif de blocage d'eau. Dans le cas où le tuyau intérieur devrait se détériorer à cause d'une usure naturelle, ce dispositif bloquera l'entrée d'eau à l'appareil. Cet inconvénient est signalé par l'apparition d'un secteur rouge dans la petite fenêtre "A". Dans ce cas fermez le robinet d'eau et remplacez le tuyau.

Wasserstop-System
Der Wasserzulaufschlauch ist mit einem Wasserstop-System ausgestattet. Sollte der Innenschlauch durch natürliche Alterung beschädigt werden, so blockiert das System die Wasserzufuhr zum Gerät. Die Störung wird durch die Erscheinung einer roten Markierung in Fensterchen "A" angezeigt. In diesem Fall muß der Wasserhahn geschlossen und der Schlauch ersetzt werden.

Waterstop-system
De watertoevoerslang is met een "waterstop-systeem" uitgerust.
Zou, door natuurlijke veroudering, de binnenslang lek raken, dan blokkeert het systeem de watergevoer.
Het optreden van deze storing kunt u zien aan rode sector in het vensterje "A". Sluit de waterkraan en vervang de slang in z'n geheel tegen een nieuwe.

Dispositivo de bloqueo del agua
El tubo de carga del agua se encuentra provisto de un dispositivo de seguridad que bloquea el flujo del agua cuando el tubo de carga se deteriora. En este caso, se observará un señal una mancha roja en la ventanilla "A" y será necesario sustituir el tubo de carga del agua.

